

1 Hydraulics **3-284**

2 Hydraulic Quick Release Couplings **285-320**

3 Pneumatic Quick Release Couplings **321-406**

4 Monitor & Test **407-446**

5 Pneumatic & Vacuum **447-762**

6 Push-in Fittings & Tubing **763-918**

7 Valves & Actuation **919-1060**

8 Ring Main **1061-1136**

9 Hose Tails, Adaptors, Fittings & Manifolds **1137-1224**

10 Stainless Steel **1225-1332**

11 Malleable Iron **1333-1398**

12 Hose, Couplings, Ducting & Hose Reels **1399-1510**

13 Clips & Clamps **1511-1558**

14 Paint, Sprays & Adhesives **1559-1590**

15 Blow Guns, Vacuum & Nozzles **1591-1616**

16 Fuelling, Lubrication, Wash Down & Misting **1617-1696**

17 Compressors & Air Tools **1697-1726**

18 Hand Tools & PPE **1727-1765**

SECTION 6

Push-in Fittings & Tubing

6.01 Plastic Push-in Fittings **763-842**

6.02 Metal Push-in Fittings **843-874**

6.03 Stainless Steel Push-in Fittings **875-879**

6.04 Plumbing Push-in Fittings **880-886**

6.05 Air Brake Push-in Fittings **887-894**

6.06 Polyurethane & Nylon Tubing **895-918**

6

SECTION 6

6.01 Plastic Push-in Fittings



763-842

- One Touch Emergency Fittings Kits
- One Touch Plastic (Metric)
- One Touch NPT Plastic (Imperial)
- One Touch+ Emergency Fittings Kits (16 bar rated)
- Micro One Touch (Metric)
- Mirco One Touch (Imperial) NPT & UNI
- Check & Stop Valves
- LF 3000®
- Leak Free
- NPT Threads x Imperial Tube
- BSP Threads x Metric Tube
- Flow Control Regulators Polymer Version
- Flow Control Regulators & Function Fittings
- QS Standard Series
- QS Miniature Series
- Function Fittings
- 55000 Series (20 bar Rated)
- 55000 Series Metal Body
- 55000 Series Miniature
- Metric Push-in Fittings
- Technopolymer
- Push-in Fittings Kits
- Flow Micro Regulators
- Block Fittings
- Flow Control Valves
- Functional Fittings Series 7000 Super Rapid
- Compact Fittings
- Push-in Fittings (Metric)
- Push-in Fittings (Imperial)



new product

6.02 Metal Push-in Fittings



843-874

- One Touch Emergency Fittings Kits
- One Touch All Metal, LF 3600®
- Centralised Lubrication System Fittings
- 50000 Series - Brass
- 89000 Series Imperial Tube Fittings
- 50000 Series Metal Body
- 50000 Series Brass
- 58000 Series High Pressure Lubrication Fittings
- Food Grade
- Pneufi® Push-in Fittings (Metric/Imperial)
- Non Return Valves & Fittings
- Food Grade Fittings
- Nickel Plated Brass & Technopolymer
- Metric Push-in Fittings
- Nickel Plated Brass
- Super-Rapid
- Push-in Fittings
- Series 8000 Super-Rapid Fittings
- Series H8000 Dual Seal Super-Rapid Fittings



6.03 Stainless Steel Push-in Fittings



875-879

- One Touch All Stainless Steel Push-in Fittings
- 316 Stainless Steel Push-in Fittings



stainless steel

Push-in Fittings & Tubing

6.04 Plumbing Push-in Fittings

- Plastic Push-in Fittings
- Plastic Push-in Fittings Pipes & Cutters
- Fitting Valves Piping & Accessories Range
- Brass Push-in Plumbing Tube Fittings



880-886



6.05 Air Brake Push-in Fittings

- Air Brake Fittings
- Air Brake Swivel Fittings
- Air Brake Threaded Fittings C Truck 9000 Series
- Air Brake Accessories C Truck 9000 Series



887-894



6.06 Polyurethane & Nylon Tubing

- Polyurethane Tube
- Polyurethane Recoil Hoses, Polyurethane Tube & Assemblies
- Polyurethane Anti-Spatter Tube & Hose
- Tube & Hose Cutters
- Tubing
- Specialist Tubing
- Automotive Tubing & Hose
- Festo Polyurethane Tubing
- Nylon Tubing & Tube Cutters
- Nylon Tubing
- LLDPE & Synflex ube



895-918





PLASTIC PUSH-IN FITTINGS BSP & Metric Threads x Metric Tube



Features:

- Convenient One Touch fittings provide instant connections
- Elliptical release ring facilitates pneumatic installation in confined spaces
- Light manual pressure on the elliptical release ring is all that is required to instantly disconnect each tube; no special tools required
- Nickel-plated brass threaded body ensures anti-corrosion and anti-contamination
- All taper threaded fittings are pre-coated with PTFE sealant and require no additional sealing

 **Working Temperature:**
0°C to +60°C

 **Maximum Working Pressure:**
10 bar (150 psi)

Construction:

Resin Body:	PBT
Metal Body:	Nickel-plated brass
Packing:	Nitrile
Back Ring:	POM
O-Ring:	Nitrile
Collar:	Nickel-plated zinc
Sleeve:	POM
Locking Claw:	Stainless steel
Media:	Air and vacuum
Threads:	BSPP, BSPT, metric
OD:	Metric

PLASTIC PUSH-IN FITTINGS

One Touch Emergency Fittings Kits



Convenient, compact boxes containing a selection of popular FT Pro One Touch plastic push-in fittings along with handy tube cutter.

Available in three sizes: 6mm, 8mm and 10mm. Can be used with nylon 6, 11, 12, and polyurethane (ester and ether).

 **Working Temperature:**
Brass & Acetal:
0°C to +60°C*

 **Maximum Working Pressure:**
10 bar (150 psi)*
Negative Pressure:
-750mm Hg (10 Torr)*

Media:
Air and vacuum only.

Plastic Push-in

1060	OD mm
FTP-06MMBOX-P	6
FTP-08MMBOX-P	8
FTP-10MMBOX-P	10

Tech Sheet 1964



Contents:

6mm

Plastic Push-in Fittings & Tube Cutter

1 x Tube Cutter KTC-1	10 x Equal Tees 2019-8404	10 x Equal Connectors 2019-8305	2 x Equal Bulkheads 2019-8503
8 x Equal Elbows 2019-8354	8 x 1/8" BSPP Male Stud Elbows 2028-8247	5 x 1/4" BSPP Male Stud Elbows 2028-8254	
2 x 1/8" BSPT Flow Controllers 2022-9852	2 x 1/4" BSPT Flow Controllers 2022-9878	2 x Flow Controllers (Unidirectional) 2022-9746	
10 x 1/8" BSPT Male Studs 2019-4965	10 x 1/4" BSPT Male Studs 2019-4973	2 x Shut Off Valves (Tube x Tube) HVFF06-06	
5 x M5 BSPT Male Studs 2019-4957	10 x 1/8" BSPP Male Studs 2028-7819	10 x 1/4" BSPP Male Studs 2028-7843	

8mm

Plastic Push-in Fittings & Tube Cutter

1 x Tube Cutter KTC-1	8 x Equal Tees 2019-8412	10 x Equal Connectors 2019-8313	2 x Equal Bulkheads 2019-8511
6 x Equal Elbows 2019-8362	6 x 1/8" BSPP Male Stud Elbows 2028-8270	5 x 1/4" BSPP Male Stud Elbows 2028-8288	
2 x 1/8" BSPT Flow Controllers 2022-9886	2 x 1/4" BSPT Flow Controllers 2022-9894	2 x Flow Controllers (Unidirectional) 2022-9753	
10 x 1/8" BSPT Male Studs 2019-4999	10 x 1/4" BSPT Male Studs 2019-5004	2 x Shut Off Valves (Tube x Tube) HVFF08-08	
5 x 3/8" BSPT Male Studs 2019-5012	10 x 1/8" BSPP Male Studs 2028-7876	10 x 1/4" BSPP Male Studs 2028-7884	

10mm

Plastic Push-in Fittings & Tube Cutter

1 x Tube Cutter KTC-1	2 x Flow Controllers (Unidirectional) 2022-9761	8 x Equal Connectors 2019-8321
3 x Equal Elbows 2019-8370	3 x 1/8" BSPP Male Stud Elbows 2028-8312	3 x 1/4" BSPP Male Stud Elbows 2028-8320
2 x 1/4" BSPT Flow Controllers 2022-9928	1 x 3/8" BSPT Flow Controller 2022-9936	2 x Equal Tees 2019-8420
7 x 1/8" BSPT Male Studs 2019-5038	7 x 1/4" BSPT Male Studs 2019-5046	2 x Equal Bulkheads 2019-8529
5 x 3/8" BSPT Male Studs 2019-5053	8 x 1/8" BSPP Male Studs 2028-7926	6 x 1/4" BSPP Male Studs 2028-7934

*Dependent upon tubing specification.

ONE TOUCH PLASTIC PUSH-IN FITTINGS, METRIC



Working Temperature:
0°C to +60°C



Maximum Working Pressure:
10 bar (150 psi)

Media:
Air and vacuum only.

Negative Pressure:
-750mm Hg (10 Torr)

Male Studs



Male Thread, Metric & BSPT

1060	OD mm	Thread
2019-4890	4	M5
2019-4932	4	1/8"
2046-7163	4	M6
2019-4940	4	1/4"
2046-7164	4	3/8"
2019-4957	6	M5
2019-4965	6	1/8"
2046-7165	6	M6
2019-4973	6	1/4"
2019-4981	6	3/8"
2046-7166	6	1/2"
2019-4999	8	1/8"
2019-5004	8	1/4"
2019-5012	8	3/8"
2019-5020	8	1/2"
2019-5038	10	1/8"
2019-5046	10	1/4"
2019-5053	10	3/8"
2019-5061	10	1/2"
2019-5076	12	1/4"
2019-5087	12	3/8"
2019-5095	12	1/2"
2019-5096	16	3/8"
2019-5097	16	1/2"

Tech Sheet 1964

Male Thread, Metric & BSPT



1060	OD mm	Thread
2019-0010	4	M5
2019-0011	4	M6
2019-0012	4	1/8"
2019-0013	4	1/4"
2019-0014	6	M5
2019-0015	6	M6
2019-0016	6	1/8"
2019-0017	6	1/4"
2019-0018	6	3/8"
2019-0019	6	1/2"
2019-0020	8	1/8"
2019-0021	8	1/4"
2019-0022	8	3/8"
2019-0023	8	1/2"
2019-0024	10	1/8"
2019-0025	10	1/4"
2019-0026	10	3/8"
2019-0027	10	1/2"
2019-0028	12	1/4"
2019-0029	12	3/8"
2019-0030	12	1/2"
2019-0031	16	3/8"
2019-0032	16	1/2"

Female Studs



Female Thread, BSPP

1060	OD mm	Thread
2019-6325	4	1/8"
2046-7167	4	1/4"
2019-6366	6	1/8"
2019-6416	6	1/4"
2019-6432	6	3/8"
2019-6440	8	1/8"
2019-6465	8	1/4"
2019-6721	8	3/8"
2046-7168	8	1/2"
2019-6739	10	1/8"
2019-6754	10	1/4"
2019-6911	10	3/8"
2046-7169	10	1/2"
2019-6929	12	1/4"
2019-7018	12	3/8"
2019-7059	12	1/2"

Tech Sheet 1964

Female Bulkhead Connectors



Female Thread, Metric & BSPP

1060	OD mm	Thread	Bulkhead
2046-7194	4	M5	M12 x 1
2019-7083	4	1/8"	M12 x 1
2046-7196	4	1/4"	M12 x 1
2046-7197	6	M5	M14 x 1
2019-7125	6	1/8"	M14 x 1
2046-7198	6	M6	M14 x 1
2019-7133	6	1/4"	M14 x 1
2046-7199	6	3/8"	M14 x 1
2046-7200	6	1/2"	M14 x 1
2046-7201	8	1/8"	M16 x 1
2019-7166	8	1/4"	M16 x 1
2019-7182	8	3/8"	M16 x 1
2046-7202	8	1/2"	M16 x 1
2046-7203	10	1/8"	M20 x 1
2019-7299	10	1/4"	M20 x 1
2019-7307	10	3/8"	M20 x 1
2046-7204	10	1/2"	M20 x 1
2019-7315	12	1/4"	M22 x 1
2019-7497	12	3/8"	M22 x 1
2046-7205	12	1/2"	M22 x 1

Tech Sheet 1964

Male Thread, BSPP



1060	OD mm	Thread
2028-7736	4	1/8"
2028-7793	4	1/4"
2028-7819	6	1/8"
2028-7843	6	1/4"
2028-7868	6	3/8"
2028-7876	8	1/8"
2028-7884	8	1/4"
2028-7900	8	3/8"
2028-7918	8	1/2"
2028-7926	10	1/8"
2028-7934	10	1/4"
2028-7942	10	3/8"
2028-7959	10	1/2"
2028-7967	12	1/4"
2028-7975	12	3/8"
2028-7983	12	1/2"
2028-7986	16	3/8"
2028-7987	16	1/2"

Tech Sheet 1964



**For Brass Nickel
Plated Hose Tails**
see pages 1140-1146

Working Temperature:
 Brass: 0°C to +60°C
 Acetal: 0°C to +60°C

Maximum Working Pressure:
 10 bar (150 psi)

Media:
 Air and vacuum only.

Negative Pressure:
 -750mm Hg (10 Torr)

Male Stud Swivel Elbows



Male Thread, Metric & BSPT

1060	OD mm	Thread
2019-5103	4	M5
2019-5111	4	1/8"
2046-7170	4	M6
2019-5129	4	1/4"
2019-5822	6	M5
2019-5145	6	1/8"
2046-7171	6	M6
2019-5152	6	1/4"
2019-5160	6	3/8"
2046-7172	6	1/2"
2019-5178	8	1/8"
2019-5186	8	1/4"
2019-5194	8	3/8"
2019-5202	8	1/2"
2019-5210	10	1/8"
2019-5228	10	1/4"
2019-5236	10	3/8"
2019-5244	10	1/2"
2019-5251	12	1/4"
2019-5269	12	3/8"
2019-5277	12	1/2"
2019-5278	16	3/8"
2019-5279	16	1/2"

Tech Sheet 1964



Male Thread, BSPP

1060	OD mm	Thread
2028-8221	4	1/8"
2028-8239	4	1/4"
2028-8247	6	1/8"
2028-8254	6	1/4"
2028-8262	6	3/8"
2028-8270	8	1/8"
2028-8288	8	1/4"
2028-8296	8	3/8"
2028-8304	8	1/2"
2028-8312	10	1/8"
2028-8320	10	1/4"
2028-8338	10	3/8"
2028-8379	10	1/2"
2028-8403	12	1/4"
2028-8411	12	3/8"
2028-8429	12	1/2"

Tech Sheet 1964

Male Stud Swivel Elbows



Extended Male Thread, Metric & BSPT

1060	OD mm	Thread
2019-5905	4	M5
2019-5913	4	1/8"
2019-5939	6	M5
2019-5947	6	1/8"
2046-7191	6	M6
2019-5954	6	1/4"
2019-5970	8	1/8"
2019-5988	8	1/4"
2019-6135	10	1/8"
2019-6150	10	1/4"
2019-6192	12	1/4"
2019-6200	12	3/8"

Tech Sheet 1964



Extended Male Thread, BSPP

1060	OD mm	Thread
2033-8729	4	1/8"
2033-8737	4	1/4"
2033-8745	6	1/8"
2033-8752	6	1/4"
2033-8778	6	3/8"
2033-8786	8	1/8"
2033-9107	8	1/4"
2033-9115	8	3/8"
2033-9131	10	1/8"
2033-9149	10	1/4"
2033-9156	10	3/8"
2033-9180	12	3/8"

Tech Sheet 1964

45° Male Stud Elbows



Male Thread, BSPT

1060	OD mm	Thread
2019-0210	6	1/8"
2019-0211	6	1/4"



For Silencers
 see page 631

ONE TOUCH PLASTIC PUSH-IN FITTINGS, METRIC



Working Temperature:
Brass: 0°C to +60°C
Acetal: 0°C to +60°C



Maximum Working Pressure:
10 bar (150 psi)

Media:
Air and vacuum only.

Negative Pressure:
-750mm Hg (10 Torr)

Male Stud Swivel Tees



Branch Male Thread, Metric & BSPT

1060	OD mm	Thread
2019-5293	4	M5
2019-5301	4	1/8"
2019-5335	4	1/4"
2019-5541	6	M5
2019-5749	6	1/8"
2019-5764	6	1/4"
2019-5772	6	3/8"
2046-7175	6	1/2"
2019-5780	8	1/8"
2019-5798	8	1/4"
2019-5806	8	3/8"
2019-5814	8	1/2"
2019-5830	10	1/8"
2019-5848	10	1/4"
2019-5855	10	3/8"
2019-5863	10	1/2"
2019-5871	12	1/4"
2019-5889	12	3/8"
2019-5897	12	1/2"

Tech Sheet 1964



Branch Male Thread, BSPP

1060	OD mm	Thread
2028-8007	4	1/8"
2028-8023	4	1/4"
2028-8031	6	1/8"
2028-8049	6	1/4"
2028-8056	6	3/8"
2028-8064	8	1/8"
2028-8072	8	1/4"
2028-8122	8	3/8"
2028-8130	8	1/2"
2028-8148	10	1/8"
2028-8155	10	1/4"
2028-8163	10	3/8"
2028-8189	12	1/4"
2028-8205	12	3/8"
2028-8213	12	1/2"

Tech Sheet 1964



Run Male Thread, Metric & BSPT

1060	OD mm	Thread
2019-7992	4	M5
2019-8008	4	1/8"
2019-8010	4	1/4"
2019-8012	6	M5
2019-8032	6	1/8"
2019-8040	6	1/4"
2019-8057	6	3/8"
2019-8065	8	1/8"
2019-8073	8	1/4"
2019-8081	8	3/8"
2019-8089	8	1/2"
2019-8107	10	1/8"
2019-8115	10	1/4"
2019-8123	10	3/8"
2019-8156	12	3/8"
2019-8164	12	1/2"

Tech Sheet 1964



Run Male Thread, BSPP

1060	OD mm	Thread
2033-8570	6	1/8"
2033-8588	6	1/4"
2033-8612	8	1/4"

Tech Sheet 1964

Male Stud Swivel Ys



Male Thread, Metric & BSPT

1060	OD mm	Thread
2019-7513	4	1/8"
2019-7547	6	1/8"
2019-7554	6	1/4"
2019-7570	6	3/8"
2019-7596	8	1/8"
2019-7604	8	1/4"
2019-7612	8	3/8"
2019-7620	8	1/2"
2019-7638	10	1/8"
2019-7646	10	1/4"
2019-7653	10	3/8"
2019-7950	10	1/2"
2019-7968	12	1/4"
2019-7976	12	3/8"
2019-7984	12	1/2"

Tech Sheet 1964



For **Combination Nipples**
see page 1497

Working Temperature:
 Brass: 0°C to +60°C
 Acetal: 0°C to +60°C

Maximum Working Pressure:
 10 bar (150 psi)

Media:
 Air and vacuum only.

Negative Pressure:
 -750mm Hg (10 Torr)

Tube x Tube Connectors



Equal Straights

1060	OD mm
2019-8297	4
2019-8305	6
2019-8313	8
2019-8321	10
2019-8339	12
2019-8340	16

Tech Sheet 1964



Equal Tees

1060	OD mm
2019-8396	4
2019-8404	6
2019-8412	8
2019-8420	10
2019-8438	12
2019-8439	16

Tech Sheet 1964



Equal Crosses

1060	OD mm
2019-8974	4
2019-8982	6
2019-8990	8
2019-9006	10
2019-9014	12

Tech Sheet 1964



Unequal Straights

1060	OD mm	OD mm
2019-8545	4	6
2019-8552	6	8
2019-8560	8	10
2019-8578	10	12
2019-8579	12	16

Tech Sheet 1964



Equal Ys

1060	OD mm
2019-8446	4
2019-8453	6
2019-8461	8
2019-8479	10
2019-8487	12

Tech Sheet 1964



Equal Bulkheads

1060	OD mm	Bulkhead
2019-8495	4	M12 x 1
2019-8503	6	M14 x 1
2019-8511	8	M16 x 1
2019-8529	10	M20 x 1
2019-8537	12	M22 x 1

Tech Sheet 1964



Equal Elbows

1060	OD mm
2019-8347	4
2019-8354	6
2019-8362	8
2019-8370	10
2019-8388	12
2019-8392	16

Tech Sheet 1964



Unequal Ys

1060	OD mm	OD mm
2019-9139	6	4
2019-9162	8	6
2019-9170	10	8
2019-9188	12	10

Tech Sheet 1964



For Manual & Mechanical Valves
 see pages 545-549

ONE TOUCH PLASTIC PUSH-IN FITTINGS, METRIC



Tube x Stem Connectors



Straights, Tube x Stem

1060	OD mm	Stem OD mm
2028-8437	4	6
2028-8445	4	8
2028-8452	6	8
2028-8460	6	10
2028-8478	8	10
2028-8486	8	12
2028-8494	10	12

Tech Sheet 1964



BSPP & Metric

1060	OD mm	Thread
2019-0220	4	M5
2019-0226	8	1/8"



Elbows, Tube x Stem

1060	OD mm	Stem OD mm
2024-2566	4	4
2024-2574	6	6
2024-2582	8	8
2024-2590	10	10
2024-2608	12	12

Tech Sheet 1964

Ys, Tube x Stem

1060	OD mm	Stem OD mm
2024-2616	4	4
2024-2624	6	6
2024-2632	8	8
2024-2640	10	10
2024-2657	12	12

Tech Sheet 1964



Reducing Ys, Tube x Stem

1060	OD mm	Stem OD mm
2024-2673	4	6
2024-2699	6	8
2024-2731	8	10

Tech Sheet 1964

Plugs



Tube

1060	OD mm
2028-8627	4
2028-8635	6
2028-8643	8
2028-8668	10
2028-8684	12

Tech Sheet 1964

Equal Double Joint Adaptors



Tube x Tube

1060	OD mm
2028-8502	4
2028-8510	6
2028-8528	8
2028-8536	10
2028-8544	12

Tech Sheet 1964

Reducers



Tube x Tube

1060	OD mm	Stem OD mm
2028-8551	6	4
2028-8569	8	4
2028-8577	8	6
2028-8585	10	6
2028-8593	10	8
2028-8601	12	8
2028-8619	12	10

Tech Sheet 1964

Tube Plugs



Tube

1060	OD mm
2033-8505	4
2033-8513	6
2033-8521	8
2033-8539	10
2033-8547	12

Tech Sheet 1964

Single Banjos



Male Thread, Metric & BSPT

1060	OD mm	Thread
2019-8172	4	M5
2019-8180	4	1/8"
2046-7183	4	M6
2019-8198	6	M5
2019-8206	6	1/8"
2046-7185	6	M6
2019-8214	6	1/4"
2046-7186	6	3/8"
2019-8222	8	1/8"
2019-8230	8	1/4"
2019-8248	8	3/8"
2046-7188	10	1/4"
2019-8255	10	3/8"
2019-8263	10	1/2"
2046-7189	12	1/4"
2019-8271	12	3/8"
2019-8289	12	1/2"

Tech Sheet 1964

Working Temperature:
 Brass: 0°C to +60°C
 Acetal: 0°C to +60°C

Maximum Working Pressure:
 10 bar (150 psi)

Media: Air and vacuum only.
Negative Pressure: -750mm Hg (10 Torr)

Reducing Manifolds



Male Thread, BSPT

1060	Inlet OD mm	Outlet OD mm	Thread
2019-9022	6	4	1/8"
2019-9035	8	4	1/4"
2019-9048	8	6	1/4"
2019-9055	10	8	3/8"

Tech Sheet 1964



Tube x Tube

1060	Inlet OD mm	Outlet OD mm
2019-9063	6	4
2019-9071	8	4
2019-9089	8	6
2019-9097	10	6
2023-0637	10	8

Tech Sheet 1964



For **Metric Polyurethane Tubing**
 see pages **897-900**

Speed Control Valves



In-line, Tube x Tube

1060	OD mm
2022-9720	4
2022-9746	6
2022-9753	8
2022-9761	10
2022-9779	12

Tech Sheet 1964



Elbow, Male Thread, Metric & BSPT

1060	OD mm	Thread
2022-9829	4	M5
2022-9845	4	1/8"
2022-9860	4	1/4"
2022-9837	6	M5
2022-9852	6	1/8"
2046-7181	6	M6
2022-9878	6	1/4"
2022-9902	6	3/8"
2022-9886	8	1/8"
2022-9894	8	1/4"
2022-9910	8	3/8"
2046-7182	8	1/2"
2022-9928	10	1/4"
2022-9936	10	3/8"
2022-9969	10	1/2"
2022-9944	12	1/4"
2022-9951	12	3/8"
2022-9977	12	1/2"

Tech Sheet 1964

Manual Shut Off Valves

Maximum Working Pressure:
 7 bar (100 psi)



BSPT x BSPT

1060	Thread	Thread
HVSS-01-01	1/8"	1/8"
HVSS-02-01	1/4"	1/8"
HVSS-02-02	1/4"	1/4"
HVSS-02-03	1/4"	3/8"
HVSS-03-03	3/8"	3/8"
HVSS-04-03	1/2"	3/8"
HVSS-04-04	1/2"	1/2"

Tech Sheet 1964



Tube x BSPT

1060	OD mm	Thread
HVFS6-01	6	1/8"
HVFS6-02	6	1/4"
HVFS6-03	6	3/8"
HVFS8-01	8	1/8"
HVFS8-02	8	1/4"
HVFS8-03	8	3/8"

Tech Sheet 1964

Maximum Working Pressure:
 7 bar (100 psi)



Tube x Tube, Venting

1060	OD mm	OD mm
HVFF06-06	6	6
HVFF08-06	8	6
HVFF08-08	8	8
HVFF10-10	10	10
HVFF12-10	12	10
HVFF12-12	12	12

Tech Sheet 1964



PLASTIC PUSH-IN FITTINGS NPT & UNF Threads x Metric & Imperial Tube



Features:

- Convenient One Touch fittings provide instant connections
- Elliptical release ring facilitates pneumatic installation in confined spaces
- Light manual pressure on the elliptical release ring is all that is required to instantly disconnect each tube; no special tools required
- Nickel-plated brass threaded body ensures anti-corrosion and anti-contamination
- All taper threaded fittings are pre-coated with PTFE sealant and require no additional sealing

 **Working Temperature:**
-10°C to +60°C

 **Maximum Working Pressure**
10 bar (150 psi)

Construction:

Resin Body:	PBT
Metal Body:	Nickel-plated brass
Packing:	Nitrile
Back Ring:	POM
O-Ring:	Nitrile
Collar:	Nickel-plated zinc
Sleeve:	POM
Locking Claw:	Stainless steel
Media:	Air and vacuum
Threads:	NPT, UNF
OD:	Metric and imperial tube sizes

ONE TOUCH NPT PLASTIC PUSH-IN FITTINGS, IMPERIAL



Working Temperature:
0°C to +60°C

Maximum Working Pressure:
10 bar (150 psi)

Media:
Air and vacuum only.

Negative Pressure:
-750mm Hg (10 Torr)

Male Studs



Male Thread (Hex Body), NPT

1101	OD	Thread
2110-7800	1/8"	1/8"
2110-7826	1/8"	1/4"
2110-7842	5/32"	1/8"
2110-7859	5/32"	1/4"
2110-7875	3/16"	1/8"
2110-7909	3/16"	1/4"
2110-7925	3/16"	3/8"
2110-7941	1/4"	1/8"
2110-7958	1/4"	1/4"
2110-7966	1/4"	3/8"
2110-7974	5/16"	1/8"
2110-7982	5/16"	1/4"
2110-7990	5/16"	3/8"
2110-8006	3/8"	1/8"
2110-8014	3/8"	1/4"
2110-8022	3/8"	1/2"
2110-8063	1/2"	1/4"
2110-8071	1/2"	3/8"
2110-8089	1/2"	1/2"

Tech Sheet 1964

Male Thread (Hex Body), UNF

1101	OD	Thread
2110-7776	1/8"	10-32
2110-7834	5/32"	10-32
2110-7933	1/4"	10-32

Tech Sheet 1964



Male Thread (Round), NPT

1101	OD	Thread
2110-8105	1/8"	1/8"
2110-8113	1/8"	1/4"
2110-8139	5/32"	1/8"
2110-8147	5/32"	1/4"
2110-8188	3/16"	1/8"
2110-8204	3/16"	1/4"
2110-8220	3/16"	3/8"
2110-8246	1/4"	1/8"
2110-8253	1/4"	1/4"
2110-8279	1/4"	3/8"
2110-8287	1/4"	1/8"
2110-8295	1/4"	1/4"
2110-8303	1/4"	3/8"
2110-8311	3/8"	1/8"
2110-8329	3/8"	1/4"
2110-8337	3/8"	3/8"
2110-8345	3/8"	1/2"
2110-8352	1/2"	1/4"
2110-8360	1/2"	3/8"
2110-8378	1/2"	1/2"

Tech Sheet 1964

Male Thread (Round), UNF

1101	OD	Thread
2110-8097	1/8"	10-32
2110-8121	5/32"	10-32
2110-8154	3/16"	10-32
2110-8238	1/4"	10-32

Tech Sheet 1964

Female Studs



Female Thread, NPT

1101	OD	Thread
2110-8386	1/8"	1/8"
2110-8394	1/8"	1/4"
2110-8402	5/32"	1/8"
2110-8410	5/32"	1/4"
2110-8428	3/16"	1/8"
2110-8436	3/16"	1/4"
2110-8444	1/4"	1/8"
2110-8451	1/4"	1/4"
2110-8469	1/4"	3/8"
2110-8477	5/16"	1/8"
2110-8485	5/16"	1/4"
2110-8493	5/16"	3/8"
2110-8519	3/8"	1/8"
2110-8527	3/8"	1/4"
2110-8535	3/8"	3/8"
2110-8543	3/8"	1/2"
2110-8550	1/2"	1/4"
2110-8568	1/2"	3/8"
2110-8576	1/2"	1/2"

Tech Sheet 1964



You might also need
Nylon Tubing
see page 913

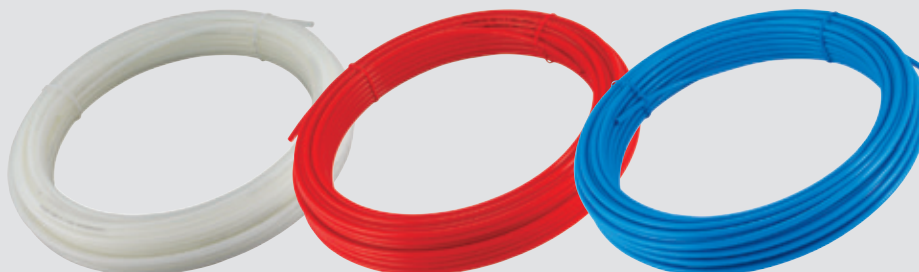

ONE TOUCH NPT PLASTIC PUSH-IN FITTINGS, IMPERIAL



Working Temperature:
Brass: 0°C to +60°C
Acetal: 0°C to +60°C



Maximum Working Pressure:
10 bar (150 psi)

Media:
Air and vacuum only.

Negative Pressure:
-750mm Hg (10 Torr)

Male Stud Swivel Elbows



Male Thread, NPT

1101	OD	Thread
2110-8592	1/8"	1/8"
2110-8600	1/8"	1/4"
2110-8626	5/32"	1/8"
2110-8634	5/32"	1/4"
2110-8659	3/16"	1/8"
2110-8667	3/16"	1/4"
2110-8691	3/16"	3/8"
2110-8717	1/4"	1/8"
2110-8725	1/4"	1/4"
2110-8733	1/4"	3/8"
2110-8741	5/16"	1/8"
2110-8758	5/16"	1/4"
2110-8766	5/16"	3/8"
2110-8774	3/8"	1/8"
2110-8782	3/8"	1/4"
2110-8790	3/8"	3/8"
2110-8808	3/8"	1/2"
2110-8816	1/2"	1/4"
2110-8824	1/2"	3/8"
2110-8832	1/2"	1/2"

Tech Sheet 1964

Male Thread, UNF

1101	OD	Thread
2110-8584	1/8"	10-32
2110-8618	5/32"	10-32
2110-8709	1/4"	10-32

Tech Sheet 1964



Extended Male Thread, NPT

1101	OD	Thread
2110-8857	1/8"	1/8"
2110-8865	1/8"	1/4"
2110-8907	5/32"	1/4"
2110-8923	3/16"	1/8"
2110-8931	3/16"	1/4"
2110-8949	3/16"	3/8"
2110-8964	1/4"	1/8"
2110-8972	1/4"	1/4"
2110-8980	1/4"	3/8"
2110-8998	5/16"	1/8"
2110-9004	5/16"	1/4"
2110-9020	3/8"	1/8"
2110-9038	3/8"	1/4"
2110-9046	3/8"	3/8"
2110-9053	3/8"	1/2"
2110-9061	1/2"	1/4"
2110-9087	1/2"	1/2"

Tech Sheet 1964

Extended Male Thread, UNF

1101	OD	Thread
2110-8840	1/8"	10-32
2110-8881	5/32"	10-32
2110-8915	3/16"	10-32
2110-8956	1/4"	10-32

Tech Sheet 1964

Female Swivel Elbows



Female Thread, NPT

1101	OD	Thread
2110-9095	1/8"	1/8"
2110-9111	5/32"	1/8"
2110-9129	5/32"	1/4"
2110-9137	3/16"	1/8"
2110-9145	3/16"	1/4"
2110-9178	1/4"	1/8"
2110-9186	1/4"	1/4"
2110-9194	1/4"	3/8"
2110-9202	5/16"	1/8"
2110-9228	5/16"	1/4"
2110-9236	5/16"	3/8"
2110-9251	5/16"	1/2"
2110-9277	3/8"	1/8"
2110-9269	3/8"	1/4"
2110-9285	3/8"	3/8"
2110-9293	3/8"	1/2"
2111-0093	1/2"	1/4"
2111-0101	1/2"	3/8"
2111-0119	1/2"	1/2"

Tech Sheet 1964



You might also need **Solenoid Valves**
see pages **1031-1034**

ONE TOUCH NPT PLASTIC PUSH-IN FITTINGS, IMPERIAL



Male Stud Elbow



Male Thread, BSPT

1060	OD	Thread
PL1/4-01	1/4"	1/8"
PL1/4-02	1/4"	1/4"
PL3/8-01	3/8"	1/8"
PL3/8-02	3/8"	1/4"
PL1/2-03	1/2"	3/8"
PL1/2-04	1/2"	1/2"

Male Stud Tees



Male Thread, BSPT

1060	OD	Thread
PB1/4-01	1/4"	1/8"
PB1/4-02	1/4"	1/4"
PB3/8-02	3/8"	1/4"
PB1/2-02	1/2"	1/4"



Male Thread, NPT

1060	OD	Thread
PB1/8-N01	1/8"	1/8"
PB1/4-N02	1/4"	1/4"

Male Studs



Male Thread, BSPT

1060	OD	Thread
PC1/4-01	1/4"	1/8"
PC1/4-02	1/4"	1/4"
PC3/8-01	3/8"	1/8"
PC3/8-02	3/8"	1/4"
PC3/8-04	3/8"	1/2"
PC1/2-03	1/2"	3/8"
PC1/2-04	1/2"	1/2"

Plugs



Tube

1060	OD
PP1/8	1/8"
PP1/4	1/4"
PP3/8	3/8"
PP1/2	1/2"

Female Studs



Female Thread, BSPP

1060	OD	Thread
PCF1/4-01	1/4"	1/8"
PCF1/4-02	1/4"	1/4"
PCF3/8-02	3/8"	1/4"
PCF3/8-04	3/8"	1/2"
PCF1/2-03	1/2"	3/8"
PCF1/2-04	1/2"	1/2"

Tube Cap



Tube

1060	OD
PPF1/2	1/2"

Tube x Tube Connectors



Equal Straights

1060	OD
PU1/8	1/8"
PU1/4	1/4"
PU3/8	3/8"
PU1/2	1/2"



Unequal Straights

1060	OD	OD
PG1/2-3/8	1/2"	3/8"



Equal Elbows

1060	OD
PV1/8	1/8"
PV1/4	1/4"
PV3/8	3/8"
PV1/2	1/2"



Equal Tees

1060	OD
PE1/8	1/8"
PE1/4	1/4"
PE3/8	3/8"
PE1/2	1/2"



Equal Bulkheads

1060	OD
PM3/8	3/8"

ONE TOUCH NPT PLASTIC PUSH-IN FITTINGS, IMPERIAL



Working Temperature:
Brass: 0°C to +60°C
Acetal: 0°C to +60°C



Maximum Working Pressure:
10 bar (150 psi)

Media:
Air and vacuum only.

Negative Pressure:
-750mm Hg (10 Torr)

Male Studs



Male Thread, NPT

1101	OD mm	Thread
2111-2420	4	1/8"
2111-2446	4	1/4"
2111-2453	4	3/8"
2111-2461	6	1/8"
2111-2479	6	1/4"
2111-2487	6	3/8"
2111-2495	8	1/8"
2111-2503	8	1/4"
2111-2511	8	3/8"
2111-2529	8	1/2"
2111-2537	10	1/8"
2111-2545	10	1/4"
2111-2552	10	3/8"
2111-2560	10	1/2"
2111-2578	12	1/4"
2111-2586	12	3/8"
2111-2594	12	1/2"

Tech Sheet 1964

Male Stud Swivel Elbows



Male Thread, NPT

1101	OD mm	Thread
2111-2768	4	1/8"
2111-2776	4	1/4"
2111-2784	6	1/8"
2111-2792	6	1/4"
2111-2800	6	3/8"
2111-2818	6	1/2"
2111-2826	8	1/8"
2111-2834	8	1/4"
2111-2842	8	3/8"
2111-2859	8	1/2"
2111-2867	10	1/8"
2111-2875	10	1/4"
2111-2883	10	3/8"
2111-2891	10	1/2"
2111-2909	12	1/4"
2111-2917	12	3/8"
2111-2925	12	1/2"

Tech Sheet 1964

Female Swivel Elbows



Female Thread, NPT

1101	OD mm	Thread
2111-3113	4	1/8"
2111-3121	4	1/4"
2111-3139	6	1/8"
2111-3147	6	1/4"
2111-3154	6	3/8"
2111-3162	8	1/8"
2111-3170	8	1/4"
2111-3196	8	3/8"
2111-3204	8	1/2"
2111-3212	10	1/8"
2111-3220	10	1/4"
2111-3238	10	3/8"
2111-3246	10	1/2"
2111-3253	12	1/4"
2111-3261	12	3/8"
2111-3279	12	1/2"

Tech Sheet 1964

Female Studs



Female Thread, NPT

1101	OD mm	Thread
2111-2602	4	1/8"
2111-2610	4	1/4"
2111-2628	6	1/8"
2111-2636	6	1/4"
2111-2644	6	3/8"
2111-2651	8	1/8"
2111-2669	8	1/4"
2111-2677	8	3/8"
2111-2685	8	1/2"
2111-2693	10	1/8"
2111-2701	10	1/4"
2111-2719	10	3/8"
2111-2727	10	1/2"
2111-2735	12	1/4"
2111-2743	12	3/8"
2111-2750	12	1/2"

Tech Sheet 1964



Extended Male Thread, NPT

1101	OD mm	Thread
2111-2933	4	1/8"
2111-2941	4	1/4"
2111-2958	6	1/8"
2111-2966	6	1/4"
2111-2974	6	3/8"
2111-2982	8	1/8"
2111-3006	8	1/4"
2111-3014	8	3/8"
2111-3030	8	1/2"
2111-3048	10	1/8"
2111-3055	10	1/4"
2111-3063	10	3/8"
2111-3071	10	1/2"
2111-3089	12	1/4"
2111-3097	12	3/8"
2111-3105	12	1/2"

Tech Sheet 1964

Male Stud Swivel Tees



Branch Male Thread, NPT

1101	OD mm	Thread
2111-3287	4	1/8"
2111-3295	4	1/4"
2111-3303	6	1/8"
2111-3311	6	1/4"
2111-3329	6	3/8"
2111-3337	8	1/8"
2111-3345	8	1/4"
2111-3352	8	3/8"
2111-3360	8	1/2"
2111-3378	10	1/8"
2111-3386	10	1/4"
2111-3394	10	3/8"
2111-3402	10	1/2"
2111-3410	12	1/4"
2111-3428	12	3/8"
2111-3436	12	1/2"

Tech Sheet 1964

ONE TOUCH NPT PLASTIC PUSH-IN FITTINGS, IMPERIAL



Working Temperature:
Brass: 0°C to +60°C
Acetal: 0°C to +60°C

Maximum Working Pressure:
10 bar (150 psi)

Media:
Air and vacuum only.

Negative Pressure:
-750mm Hg (10 Torr)

Male Stud Swivel Tees



Run Male Thread, NPT

1101	OD mm	Thread
2111-3485	4	1/8"
2111-3519	4	1/4"
2111-3527	6	1/8"
2111-3535	6	1/4"
2111-3568	8	1/8"
2111-3576	8	1/4"
2111-3584	8	3/8"
2111-3592	8	1/2"
2111-3600	10	1/4"
2111-3618	10	3/8"
2111-3626	10	1/2"
2111-3634	12	1/4"
2111-3642	12	3/8"
2111-3659	12	1/2"

Tech Sheet 1964

Male Stud Swivel Ys



Male Thread, NPT

1101	OD mm	Thread
2111-3667	4	1/8"
2111-3675	6	1/8"
2111-3683	6	1/4"
2111-3691	6	3/8"
2111-3709	8	1/8"
2111-3717	8	1/4"
2111-3725	8	3/8"
2111-3733	8	1/2"
2111-3758	10	1/4"
2111-3766	10	3/8"
2111-3774	10	1/2"
2111-3782	12	1/4"
2111-3790	12	3/8"
2111-3808	12	1/2"

Tech Sheet 1964

Female Bulkhead Connectors



Female Thread, NPT

1101	OD mm	Thread
2111-3816	4	1/8"
2111-3832	4	1/4"
2111-3840	6	1/8"
2111-3857	6	1/4"
2111-3865	6	3/8"
2111-3873	6	1/2"
2111-3881	8	1/8"
2111-3899	8	1/4"
2111-3907	8	3/8"
2111-3915	8	1/2"
2111-3923	10	1/4"
2111-3931	10	3/8"
2111-3949	10	1/2"
2111-3956	12	1/4"
2111-3964	12	3/8"
2111-3972	12	1/2"

Tech Sheet 1964

Single Banjos



Male Thread, NPT

1101	OD mm	Thread
2111-4020	4	1/8"
2111-4038	6	1/8"
2111-4053	6	1/4"
2111-4061	8	1/8"
2111-4079	8	1/4"
2111-4087	8	3/8"
2111-4095	10	3/8"
2111-4111	12	1/4"
2111-4137	12	1/2"

Tech Sheet 1964

Male x Female Thread (Stacking), NPT



1101	OD mm	Thread
2111-4145	4	1/8"
2111-4152	4	1/4"
2111-4160	6	1/8"
2111-4178	6	1/4"
2111-4186	6	3/8"
2111-4202	8	1/4"
2111-4210	8	3/8"
2111-4228	8	1/2"
2111-4236	10	1/4"
2111-4244	10	3/8"
2111-4251	10	1/2"
2111-4277	12	3/8"
2111-4285	12	1/2"

Tech Sheet 1964

Reducing Manifolds



Male Thread, NPT

1101	Inlet OD mm	Outlet OD mm	Thread
2111-3980	6	4	1/8"
2111-3998	8	4	1/4"
2111-4004	8	6	1/4"
2111-4012	10	8	3/8"

Tech Sheet 1964

Speed Control Valves



Male Thread, NPT

1101	OD mm	Thread
2111-4293	4	1/8"
2111-4301	4	1/4"
2111-4319	6	1/8"
2111-4327	6	1/4"
2111-4335	6	3/8"
2111-4343	8	1/8"
2111-4350	8	1/4"
2111-4368	8	3/8"
2111-4376	8	1/2"
2111-4384	10	1/4"
2111-4392	10	3/8"
2111-4400	10	1/2"
2111-4418	12	1/4"
2111-4426	12	3/8"
2111-4434	12	1/2"

Tech Sheet 1964

Male Thread, NPT x Tube



1101	OD mm	Thread
2111-4442	6	1/8"
2111-4459	6	1/4"
2111-4467	6	3/8"
2111-4475	8	1/8"
2111-4483	8	1/4"
2111-4491	8	3/8"

Tech Sheet 1964



PLASTIC PUSH-IN FITTINGS

One Touch+ 16 Bar Rated



Features:

- One of the highest pressure rated polymer push-in fittings available on the market
- Convenient One Touch+ fittings provide instant connections
- Elliptical release ring facilitates pneumatic installation in confined spaces
- Light manual pressure on the elliptical release ring is all that is required to instantly disconnect each tube; no special tools required
- Nickel-plated brass ensures anti-corrosion and anti-contamination
- All taper threaded fittings are pre-coated with PTFE sealant and require no additional sealing



Working Temperature:
-10°C to +60°C



Working Pressure
-0.8 bar 16 bar

*Dependent upon tubing specification.

Construction:

Resin Body:	Technopolymer resin
Metal Body:	Nickel-plated brass
Packing:	Nitrile
Back O-Ring:	POM
O-Ring:	Nitrile
Collar:	Nickel-plated zinc
Collet:	Technopolymer resin
Collet Ring:	Nickel-plated brass
Sleeve:	POM

PLASTIC PUSH-IN FITTINGS

One Touch+ Emergency Fittings Kits, 16 Bar Rated



Convenient, compact boxes containing a selection of popular FT Pro One Touch+ plastic push-in fittings along with handy tube cutter.

Available in three sizes: 6mm, 8mm and 10mm. Can be used with nylon 6, 11, 12, and polyurethane (ester and ether).

 **Working Temperature:**
0°C to +60°C

 **Maximum Working Pressure:**
16 bar (220 psi)
Negative Pressure:
-750mm Hg (10 Torr)

Media:
Air and vacuum only.

Plastic, 16 bar Rated Push-in

1103	OD mm
FTP-06MMBOX-OTP	6
FTP-08MMBOX-OTP	8
FTP-10MMBOX-OTP	10

Tech Sheet 10019



Contents:

6mm

Plastic Push-in Fittings & Tube Cutter

1 x Tube Cutter KTC-1	10 x Equal Tees 2175-1038	10 x Equal Connectors 2175-1024	2 x Equal Bulkheads 2175-1057
8 x Equal Elbows 2175-1033	8 x 1/8" BSPT Male Stud Elbows 2175-0909	5 x 1/4" BSPT Male Stud Elbows 2175-0910	
5 x 1/4" BSPP Female Bulkheads 2175-1009	4 x 6mm Equal Ys 2175-1043	2 x Shut Off Valves 2175-1127	
10 x 1/8" BSPP Male Studs 2175-0873	10 x 1/4" BSPP Male Studs 2175-0874	2 x 1/8" BSPT Single Banjos 2175-1085	
5 x M5 Male Studs 2175-0854	10 x 1/8" BSPT Male Studs 2175-0856	10 x 1/4" BSPT Male Studs 2175-0857	

8mm

Plastic Push-in Fittings & Tube Cutter

1 x Tube Cutter KTC-1	8 x Equal Tees 2175-1039	10 x Equal Connectors 2175-1025	2 x Equal Bulkheads 2175-1058
5 x Equal Elbows 2175-1034	6 x 1/8" BSPT Male Stud Elbows 2175-0913	5 x 1/4" BSPT Male Stud Elbows 2175-0914	
2 x 1/4" BSPP Female Bulkheads 2175-1013	4 x Equal Ys 2175-1044	2 x Shut Off Valves 2175-1129	
10 x 1/8" BSPT Male Studs 2175-0860	10 x 1/4" BSPT Male Studs 2175-0861	4 x 1/8" BSPT Single Banjos 2175-1088	
10 x 1/8" BSPP Male Studs 2175-0876	10 x 1/4" BSPP Male Studs 2175-0877	6 x 3/8" BSPP Male Studs 2175-0878	

10mm

Plastic Push-in Fittings & Tube Cutter

1 x Tube Cutter KTC-1	5 x Equal Tees 2175-1040	6 x Equal Connectors 2175-1026	2 x Equal Bulkheads 2175-1059
3 x Equal Elbows 2175-1035	2 x 1/8" BSPT Male Stud Elbows 2175-0917	2 x 1/4" BSPT Male Stud Elbows 2175-0918	
3 x 1/4" BSPP Female Bulkheads 2175-1017	2 x Equal Ys 2175-1045	1 x Speed Control Valve 2175-1154	
8 x 1/8" BSPP Male Studs 2175-0880	6 x 1/4" BSPP Male Studs 2175-0881	2 x 3/8" BSPT Single Banjos 2175-1092	
7 x 3/8" BSPT Male Studs 2175-0864	7 x 1/4" BSPT Male Studs 2175-0865	2 x 3/8" BSPT Male Studs 2175-0866	

*Dependent upon tubing specification.

ONE TOUCH+ PLASTIC PUSH-IN FITTINGS (16 BAR RATED)



Working Temperature:
0°C to +60°C



Maximum Working Pressure:
16 bar (220 psi)

Media:
Air and vacuum only.

Negative Pressure:
-750mm Hg (10 Torr)

Male Studs



Male Thread, Metric & BSPT

1103	OD mm	Thread
2175-0849	4	M5
2175-0850	4	M6
2175-0851	4	1/8"
2175-0852	4	1/4"
2175-0853	4	3/8"
2175-0854	6	M5
2175-0855	6	M6
2175-0856	6	1/8"
2175-0857	6	1/4"
2175-0858	6	3/8"
2175-0859	6	1/2"
2175-0860	8	1/8"
2175-0861	8	1/4"
2175-0862	8	3/8"
2175-0863	8	1/2"
2175-0864	10	1/8"
2175-0865	10	1/4"
2175-0866	10	3/8"
2175-0867	10	1/2"
2175-0868	12	1/4"
2175-0869	12	3/8"
2175-0870	12	1/2"
2207-0684	14	3/8"
2207-0685	14	1/2"
2207-0686	16	3/8"
2207-0687	16	1/2"

Tech Sheet 10019



Male Thread, BSPP

1103	OD mm	Thread
2175-0871	4	1/8"
2175-0872	4	1/4"
2175-0873	6	1/8"
2175-0874	6	1/4"
2175-0875	6	3/8"
2175-0876	8	1/8"
2175-0877	8	1/4"
2175-0878	8	3/8"
2175-0879	8	1/2"
2175-0880	10	1/8"
2175-0881	10	1/4"
2175-0882	10	3/8"
2175-0883	10	1/2"
2175-0884	12	1/4"
2175-0885	12	3/8"
2175-0886	12	1/2"
2207-0688	14	3/8"
2207-0689	14	1/2"
2207-0690	16	3/8"
2207-0691	16	1/2"

Tech Sheet 10019

Female Studs



Female Thread, BSPP

1103	OD mm	Thread
2175-0887	4	1/8"
2175-0888	4	1/4"
2175-0889	6	1/8"
2175-0890	6	1/4"
2175-0891	6	3/8"
2175-0892	8	1/8"
2175-0893	8	1/4"
2175-0894	8	3/8"
2175-0895	8	1/2"
2175-0896	10	1/8"
2175-0897	10	1/4"
2175-0898	10	3/8"
2175-0899	10	1/2"
2175-0900	12	1/4"
2175-0901	12	3/8"
2175-0902	12	1/2"
2207-0692	14	3/8"
2207-0693	14	1/2"
2207-0694	16	3/8"
2207-0695	16	1/2"

Tech Sheet 10019

Female Elbow



BSPP x Tube

1103	OD mm	Thread
2207-0800	4	1/8"
2207-0801	4	1/4"
2207-0802	6	1/8"
2207-0803	6	1/4"
2207-0804	6	3/8"
2207-0806	8	1/8"
2207-0807	8	1/4"
2207-0808	8	3/8"
2207-0809	8	1/2"
2207-0810	10	1/8"
2207-0811	10	1/4"
2207-0812	10	3/8"
2207-0813	10	1/2"
2207-0814	12	1/4"
2207-0815	12	3/8"
2207-0816	12	1/2"

Male Stud Swivel Elbows



Male Thread, Metric & BSPT

1103	OD mm	Thread
2175-0903	4	M5
2175-0904	4	M6
2175-0905	4	1/8"
2175-0906	4	1/4"
2175-0907	6	M5
2175-0908	6	M6
2175-0909	6	1/8"
2175-0910	6	1/4"
2175-0911	6	3/8"
2175-0912	6	1/2"
2175-0913	8	1/8"
2175-0914	8	1/4"
2175-0915	8	3/8"
2175-0916	8	1/2"
2175-0917	10	1/8"
2175-0918	10	1/4"
2175-0919	10	3/8"
2175-0920	10	1/2"
2175-0921	12	1/4"
2175-0922	12	3/8"
2175-0923	12	1/2"
2207-0696	14	3/8"
2207-0697	14	1/2"
2207-0698	16	3/8"
2207-0699	16	1/2"

Tech Sheet 10019



Male Thread, BSPP

1103	OD mm	Thread
2175-0924	4	1/8"
2175-0925	4	1/4"
2175-0926	6	1/8"
2175-0927	6	1/4"
2175-0928	6	3/8"
2207-0714	6	1/2"
2175-0929	8	1/8"
2175-0930	8	1/4"
2175-0931	8	3/8"
2175-0932	8	1/2"
2175-0933	10	1/8"
2175-0934	10	1/4"
2175-0935	10	3/8"
2175-0936	10	1/2"
2175-0937	12	1/4"
2175-0938	12	3/8"
2175-0939	12	1/2"
2207-0700	14	3/8"
2207-0701	14	1/2"
2207-0702	16	3/8"
2207-0703	16	1/2"

Tech Sheet 10019

ONE TOUCH+ PLASTIC PUSH-IN FITTINGS (16 BAR RATED)



Working Temperature:
0°C to +60°C

Maximum Working Pressure:
16 bar (220 psi)

Media:
Air and vacuum only.

Negative Pressure:
-750mm Hg (10 Torr)

Male Stud Swivel Elbows



Extended Male Thread, Metric & BSPT

1103	OD mm	Thread
2175-0940	4	M5
2175-0941	4	1/8"
2175-0942	4	1/4"
2175-0943	6	M5
2175-0944	6	1/8"
2175-0945	6	1/4"
2175-0946	6	3/8"
2175-0947	8	1/8"
2175-0948	8	1/4"
2175-0949	8	3/8"
2175-0950	10	1/8"
2175-0951	10	1/4"
2175-0952	10	3/8"
2175-0953	10	1/2"
2175-0954	12	1/4"
2175-0956	12	1/2"

Tech Sheet 10019

Extended Male Thread, BSPP

1103	OD mm	Thread
2175-0957	4	1/8"
2175-0958	4	1/4"
2175-0959	6	1/8"
2175-0960	6	1/4"
2175-0961	6	3/8"
2175-0962	8	1/8"
2175-0963	8	1/4"
2175-0964	10	1/8"
2175-0965	10	1/4"
2175-0966	10	3/8"
2175-0967	12	3/8"

Tech Sheet 10019

Male Stud Swivel Tees



Run Male Thread, BSPP

1103	OD mm	Thread
2175-0968	4	1/8"
2175-0969	4	1/4"
2175-0970	6	1/8"
2175-0971	6	1/4"
2175-0972	8	1/4"
2175-0973	10	1/4"

Tech Sheet 10019



Branch Male Thread, BSPP

1103	OD mm	Thread
2175-0974	4	1/8"
2175-0975	4	1/4"
2175-0976	6	1/8"
2175-0977	6	1/4"
2175-0978	6	3/8"
2175-0979	8	1/8"
2175-0980	8	1/4"
2175-0981	8	3/8"
2175-0982	8	1/2"
2175-0983	10	1/8"
2175-0984	10	1/4"
2175-0985	10	3/8"
2175-1160	10	1/2"
2175-0986	12	1/4"
2175-0987	12	3/8"
2175-0988	12	1/2"

Tech Sheet 10019

BSPT x Tube

1103	OD mm	Thread
2175-1170	4	M5
2175-1171	4	1/8"
2175-1172	4	1/4"
2175-1173	6	M5
2175-1174	6	1/8"
2175-1175	6	1/4"
2175-1176	6	3/8"
2175-1177	6	1/2"
2175-1178	8	1/8"
2175-1179	8	1/4"
2175-1180	8	3/8"
2175-1181	8	1/2"
2175-1182	10	1/8"
2175-1183	10	1/4"
2175-1184	10	3/8"
2175-1185	10	1/2"
2175-1186	12	1/4"

BSPT & Metric

1103	OD mm	Thread
2176-0001	4	M5
2176-0002	4	1/8"
2176-0003	4	1/4"
2176-0004	4	3/8"
2176-0005	6	M5
2176-0006	6	1/8"
2176-0007	6	1/4"
2176-0009	8	1/8"
2176-0011	8	3/8"
2176-0012	8	1/2"
2176-0015	10	3/8"
2176-0016	10	1/2"
2176-0018	12	3/8"
2176-0019	12	1/2"
2176-0020	16	3/8"
2176-0021	16	1/2"



ONE TOUCH+ PLASTIC PUSH-IN FITTINGS (16 BAR RATED)



Working Temperature:
0°C to +60°C



Maximum Working Pressure:
16 bar (220 psi)

Media:
Air and vacuum only.

Negative Pressure:
-750mm Hg (10Torr)

Female Bulkhead Connectors



Female Thread, BSPP

1103	OD mm	Thread
2175-1006	4	1/8"
2175-1007	4	1/4"
2175-1008	6	1/8"
2175-1009	6	1/4"
2175-1010	6	3/8"
2175-1011	6	1/2"
2175-1012	8	1/8"
2175-1013	8	1/4"
2175-1014	8	3/8"
2175-1015	8	1/2"
2175-1016	10	1/8"
2175-1017	10	1/4"
2175-1018	10	3/8"
2175-1019	10	1/2"
2175-1020	12	1/4"
2175-1021	12	3/8"
2175-1022	12	1/2"

Tech Sheet 10019

Male Stud Swivel Ys



Male Thread, Metric & BSPP

1103	OD mm	Thread
2175-0989	4	M5
2175-0990	4	1/8"
2174-1001	4	1/4"
2175-0991	6	M5
2175-0992	6	1/8"
2175-0993	6	1/4"
2175-0994	6	3/8"
2174-1002	6	1/2"
2175-0995	8	1/8"
2175-0996	8	1/4"
2175-0997	8	3/8"
2175-0998	8	1/2"
2175-0999	10	1/8"
2175-1000	10	1/4"
2175-1001	10	3/8"
2175-1002	10	1/2"
2175-1003	12	1/4"
2175-1004	12	3/8"
2175-1005	12	1/2"

Tech Sheet 10019

Tube x Tube Connectors



Equal Straights

1103	OD mm
2175-1023	4
2175-1024	6
2175-1025	8
2175-1026	10
2175-1027	12
2207-0704	14
2207-0705	16

Tech Sheet 10019



Unequal Straights

1103	OD mm	OD mm
2175-1028	6	4
2174-1005	8	4
2175-1029	8	6
2175-1030	10	8
2174-1010	12	6
2174-1015	12	8
2175-1031	12	10
2174-1020	16	12

Tech Sheet 10019



Equal Elbows

1103	OD mm
2175-1032	4
2175-1033	6
2175-1034	8
2175-1035	10
2175-1036	12
2207-0706	14
2207-0707	16

Tech Sheet 10019



Equal Tees

1103	OD mm
2175-1037	4
2175-1038	6
2175-1039	8
2175-1040	10
2175-1041	12
2207-0708	14
2207-0709	16

Tech Sheet 10019

Reducing on Branch Tees



Tube x Tube

1103	OD A mm	OD B mm	OD C mm
2174-1030	6	4	6
2174-1031	8	6	8
2174-1032	10	8	10
2174-1033	12	10	12

Tube x Tube Connectors



Equal Ys

1103	OD mm
2175-1042	4
2175-1043	6
2175-1044	8
2175-1045	10
2175-1046	12
2207-0710	14
2207-0711	16

Tech Sheet 10019



Unequal Ys

1103	OD mm	OD mm
2175-1047	4	6
2175-1048	6	8
2175-1049	8	10
2175-1050	10	12

Tech Sheet 10019

ONE TOUCH+ PLASTIC PUSH-IN FITTINGS (16 BAR RATED)



° Working Temperature:
0°C to +60°C

Maximum Working Pressure:
16 bar (220 psi)

Media:
Air and vacuum only.

Negative Pressure:
-750mm Hg (10Torr)

Tube x Tube Connectors



Equal Crosses

1103	OD mm
2175-1051	4
2175-1052	6
2175-1053	8
2175-1054	10
2175-1055	12
Tech Sheet 10019	



Equal Bulkheads

1103	OD mm
2175-1056	4
2175-1057	6
2175-1058	8
2175-1059	10
2175-1060	12
2174-1040	16
Tech Sheet 10019	



For Control Valves
see page 1056

Tube x Stem Connectors



Straights, Tube x Stem

1103	OD mm	Stem OD mm
2175-1061	4	6
2175-1062	4	8
2175-1063	6	8
2175-1064	6	10
2175-1065	8	10
2174-1070	8	12
2175-1066	10	12
Tech Sheet 10019		



Elbows, Tube x Stem

1103	OD mm	Stem OD mm
2175-1067	4	4
2175-1068	6	6
2175-1069	8	8
2175-1070	10	10
2175-1071	12	12
Tech Sheet 10019		



Ys, Tube x Stem

1103	OD mm	Stem OD mm
2175-1072	6	6
2175-1073	8	8
2175-1074	10	10
2174-1081	12	12
Tech Sheet 10019		

Plugs



Tube

1103	OD mm
2175-1075	4
2175-1076	6
2175-1077	8
2175-1078	10
2175-1079	12
Tech Sheet 10019	

Blanking Cap



1103	OD mm
2174-2000	4
2174-2001	6
2174-2002	8
2174-2003	10
2174-2004	12

Single Banjos



Male Thread, Metric & BSPT

1103	OD mm	Thread
2175-1080	4	M5
2175-1081	4	M6
2175-1082	4	1/8"
2174-2006	4	1/4"
2175-1083	6	M5
2175-1084	6	M6
2175-1085	6	1/8"
2175-1086	6	1/4"
2175-1087	6	3/8"
2175-1088	8	1/8"
2175-1089	8	1/4"
2175-1090	8	3/8"
2174-2008	10	1/8"
2175-1091	10	1/4"
2175-1092	10	3/8"
2175-1093	10	1/2"
2175-1094	12	1/4"
2175-1095	12	3/8"
2175-1096	12	1/2"
Tech Sheet 10019		

ONE TOUCH+ PLASTIC PUSH-IN FITTINGS (16 BAR RATED)



Working Temperature:
0°C to +60°C



Maximum Working Pressure:
16 bar (220 psi)

Media:
Air and vacuum only.

Negative Pressure:
-750mm Hg (10Torr)

Reducing Manifolds



Tube x Male Thread, BSPP

1103	Inlet OD mm	Outlet OD mm	Thread
2174-3000	4	4	1/8"
2174-3001	4	4	1/4"
2174-3002	6	6	1/8"
2174-3003	6	6	1/4"
2174-3004	6	6	3/8"
2175-1097	6	4	1/8"
2174-3005	8	8	1/8"
2175-1098	8	4	1/4"
2175-1099	8	6	1/4"
2174-3006	8	8	1/4"
2174-3007	8	8	3/8"
2175-1100	10	8	3/8"

Tech Sheet 10019



Tube x Tube

1103	Inlet OD mm	Outlet OD mm
2175-1101	6	4
2175-1102	8	4
2175-1103	8	6
2175-1104	10	6
2175-1105	10	8

Tech Sheet 10019

Manual Shut Off Valves

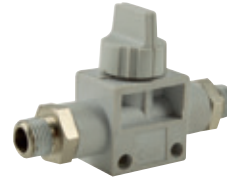

BSPT x BSPT

1103	Thread	Thread
2175-1106	1/8"	1/8"
2175-1107	1/4"	1/8"
2175-1108	1/4"	1/4"
2175-1109	1/4"	3/8"
2175-1110	3/8"	3/8"
2175-1111	1/2"	3/8"
2175-1112	1/2"	1/2"

Tech Sheet 10019



Tube x BSPT

1103	OD mm	Thread
2175-1113	6	1/8"
2175-1114	6	1/4"
2175-1115	6	3/8"
2175-1116	8	1/8"
2175-1117	8	1/4"
2175-1118	8	3/8"
2175-1119	10	1/4"
2175-1120	10	3/8"
2175-1121	10	1/2"
2175-1122	12	1/4"
2175-1123	12	3/8"
2175-1124	12	1/2"

Tech Sheet 10019



Tube x Tube

1103	OD mm	OD mm
2175-1125	4	4
2175-1126	6	4
2175-1127	6	6
2175-1128	8	6
2175-1129	8	8
2175-1130	10	10
2175-1131	12	10
2175-1132	12	12

Tech Sheet 10019

Speed Control Valves



Tube x Metric & BSPT

1103	OD mm	Thread
2175-1133	4	M5
2175-1134	4	1/8"
2175-1135	4	1/4"
2175-1136	6	M5
2175-1137	6	M6
2175-1138	6	1/8"
2175-1139	6	1/4"
2175-1140	6	3/8"
2175-1141	8	1/8"
2175-1142	8	1/4"
2175-1143	8	3/8"
2175-1144	8	1/2"
2175-1145	10	1/4"
2175-1146	10	3/8"
2175-1147	10	1/2"
2175-1148	12	1/4"
2175-1149	12	3/8"
2175-1150	12	1/2"

Tech Sheet 10019



Tube x Tube

1103	OD mm
2175-1151	4
2175-1152	6
2175-1153	8
2175-1154	10
2175-1155	12

Tech Sheet 10019



MICRO PUSH-IN FITTINGS

One Touch

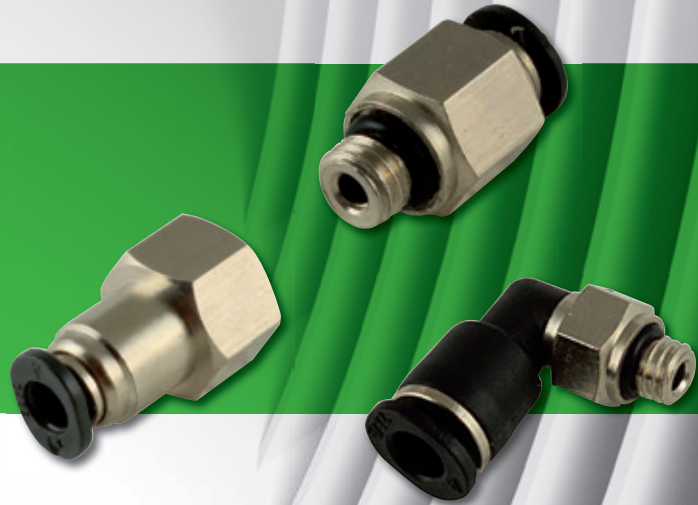

Features:

- Convenient One Touch micro fittings provide instant connections
- Elliptical release ring
- 40% less volume and 20% smaller OD compared with standard One Touch fittings, making them ideal for use in confined spaces
- Light manual pressure on the elliptical release ring is all that is required to instantly disconnect each tube; no special tools required
- Nickel plated brass ensures anti-corrosion and anti-contamination
- Available in metric, parallel and taper BSP threads, imperial NPT and UNF threads
- All taper threaded fittings are pre-coated with PTFE sealant and require no additional sealing

 **Working Temperature:**
-10°C to +60°C

 **Maximum Working Pressure**
-0.8 bar to 10 bar

*Dependent upon tubing specification.

Construction:

Resin Body:	PBT
Metal Body:	Nickel-plated brass
Packing:	Nitrile
Back Ring:	POM
O-Ring:	Nitrile
Collar:	Nickel-plated zinc
Collet:	PBT
Collet Ring:	Nickel plated brass
Sleeve:	POM

MICRO ONE TOUCH METRIC PLASTIC PUSH-IN FITTINGS



Working Temperature:
0°C to +60°C



Maximum Working Pressure:
10 bar (150 psi)

40% less volume and a 20% smaller OD than the standard One Touch design..

Micro One Touch fittings are specially designed for pneumatic systems that are used in confined spaces, saving you time and money on installations.

Male Studs

Male Thread (Hex Body), Metric



0315	OD mm	Thread
PC03-M3C	3	M3
PC04-M3C	4	M3
PC03-M5C	3	M5
PC04-M5C	4	M5
PC06-M5C	6	M5
PC03-M6C	3	M6
PC04-M6C	4	M6
PC06-M6C	6	M6

Tech Sheet 10000

Male Thread (Hex Body), BSPT

0315	OD mm	Thread
PC04-01C	4	1/8"
PC06-01C	6	1/8"

Tech Sheet 10000

Male Thread (Hex Body), BSPP

0315	OD mm	Thread
PC04-G01C	4	1/8"
PC06-G01C	6	1/8"

Tech Sheet 10000

Male Stud Elbows

Male Thread, Metric



0315	OD mm	Thread
PL03-M3C	3	M3
PL04-M3C	4	M3
PL03-M5C	3	M5
PL04-M5C	4	M5
PL06-M5C	6	M5
PL03-M6C	3	M6
PL04-M6C	4	M6
PL06-M6C	6	M6

Tech Sheet 10000

Male Thread, BSPT

0315	OD mm	Thread
PL04-01C	4	1/8"
PL06-01C	6	1/8"

Tech Sheet 10000

Male Thread, BSPP

0315	OD mm	Thread
PL04-G01C	4	1/8"
PL06-G01C	6	1/8"

Tech Sheet 10000

Male Thread (Round Body), Metric



0315	OD mm	Thread
POC03-M3C	3	M3
POC04-M3C	4	M3
POC03-M5C	3	M5
POC04-M5C	4	M5
POC06-M5C	6	M5
POC03-M6C	3	M6
POC04-M6C	4	M6
POC06-M6C	6	M6

Tech Sheet 10000

Male Thread (Round Body), BSPT

0315	OD mm	Thread
POC04-01C	4	1/8"
POC06-01C	6	1/8"

Tech Sheet 10000

Male Thread (Round Body), BSPP

0315	OD mm	Thread
POC04-G01C	4	1/8"
POC06-G01C	6	1/8"

Tech Sheet 10000

Female Studs

Female Thread (Hex Body), Metric



0315	OD mm	Thread
PCF03-M3C	3	M3
PCF04-M3C	4	M3
PCF03-M5C	3	M5
PCF04-M5C	4	M5
PCF06-M5C	6	M5
PCF03-M6C	3	M6
PCF04-M6C	4	M6
PCF06-M6C	6	M6

Tech Sheet 10000

Female Thread (Hex Body), BSPT

0315	OD mm	Thread
PCF04-01C	4	1/8"
PCF06-01C	6	1/8"

Tech Sheet 10000

Female Thread (Hex Body), BSPP

0315	OD mm	Thread
PCF04-G01C	4	1/8"
PCF06-G01C	6	1/8"

Tech Sheet 10000

Male Stud Tees

Branch Male Thread, Metric



0315	OD mm	Thread
PT03-M3C	3	M3
PT04-M3C	4	M3
PT03-M5C	3	M5
PT04-M5C	4	M5
PT06-M5C	6	M5
PT03-M6C	3	M6
PT04-M6C	4	M6
PT06-M6C	6	M6

Tech Sheet 10000

Branch Male Thread, BSPT

0315	OD mm	Thread
PT04-01C	4	1/8"
PT06-01C	6	1/8"

Tech Sheet 10000

Branch Male Thread, BSPP

0315	OD mm	Thread
PT04-G01C	4	1/8"
PT06-G01C	6	1/8"

Tech Sheet 10000

MICRO ONE TOUCH METRIC PLASTIC PUSH-IN FITTINGS



Working Temperature:
0°C to +60°C

Maximum Working Pressure:
10 bar (150 psi)

40% less volume and a 20% smaller OD

than the standard One Touch design. Micro One Touch fittings are specially designed for pneumatic systems that are used in confined spaces, saving you time and money on installations.

Male Stud Tees



Run Male Thread, Metric

0315	OD mm	Thread
PST03-M3C	3	M3
PST04-M3C	4	M3
PST03-M5C	3	M5
PST04-M5C	4	M5
PST06-M5C	6	M5
PST03-M6C	3	M6
PST04-M6C	4	M6
PST06-M6C	6	M6

Tech Sheet 10000

Run Male Thread, BSPT

0315	OD mm	Thread
PST04-01C	4	1/8"
PST06-01C	6	1/8"

Tech Sheet 10000

Run Male Thread, BSPP

0315	OD mm	Thread
PST04-G01C	4	1/8"
PST06-G01C	6	1/8"

Tech Sheet 10000



You might also need
**Polyurethane Coil
Assemblies**
see page 900

Equal Connectors



Straights

0315	OD mm
PUC03C	3
PUC04C	4
PUC06C	6

Tech Sheet 10000



Elbows

0315	OD mm
PUL03C	3
PUL04C	4
PUL06C	6

Tech Sheet 10000



Tees

0315	OD mm
PUT03C	3
PUT04C	4
PUT06C	6

Tech Sheet 10000



Ys

0315	OD mm
PY04C	4
PY06C	6

Tech Sheet 10000

Bulkheads



Equal Elbows

0315	OD mm
PLM04C	4
PLM06C	6

Tech Sheet 10000



Customers who bought
from this page also
purchased **Metric Nylon
Tubing** see page 913

MICRO ONE TOUCH IMPERIAL NPT & UNF PLASTIC PUSH-IN FITTINGS



Working Temperature:
0°C to +60°C



Maximum Working Pressure:
10 bar (150 psi)

40% less volume and a 20% smaller OD than the standard One Touch design.

Micro One Touch fittings are specially designed for pneumatic systems that are used in confined spaces, saving you time and money on installations.

Male Studs



Male Thread (Hex Body), NPT

0315	OD	Thread
PC1/8-N00C	1/8"	1/16"
PC5/32-N00C	5/32"	1/16"
PC1/4-N00C	1/4"	1/16"
PC1/8-N01C	1/8"	1/8"
PC5/32-N01C	5/32"	1/8"
PC1/4-N01C	1/4"	1/8"

Tech Sheet 10001

Male Thread (Hex Body), UNF

0315	OD	Thread mm
PC1/8-U10C	1/8"	10-32
PC5/32-U10C	5/32"	10-32
PC1/4-U10C	1/4"	10-32

Tech Sheet 10001



Male Thread (Round Body), NPT

0315	OD	Thread
POC1/8-N00C	1/8"	1/16"
POC5/32-N00C	5/32"	1/16"
POC1/4-N00C	1/4"	1/16"
POC1/8-N01C	1/8"	1/8"
POC5/32-N01C	5/32"	1/8"
POC1/4-N01C	1/4"	1/8"

Tech Sheet 10001

Male Thread (Round Body), UNF

0315	OD	Thread mm
POC1/8-U10C	1/8"	10-32
POC5/32-U10C	5/32"	10-32
POC1/4-U10C	1/4"	10-32

Tech Sheet 10001

Female Studs



Female Thread, NPT

0315	OD	Thread
PCF5/32-N00C	5/32"	1/16"
PCF1/4-N00C	1/4"	1/16"
PCF1/8-N01C	1/8"	1/8"
PCF5/32-N01C	5/32"	1/8"
PCF1/4-N01C	1/4"	1/8"

Tech Sheet 10001

Female Thread, UNF

0315	OD	Thread mm
PCF1/8-U10C	1/8"	10-32
PCF5/32-U10C	5/32"	10-32
PCF1/4-U10C	1/4"	10-32

Tech Sheet 10001



You might also need
Hose & Tube Cutters
see page 905

Male Stud Elbows



Male Thread, NPT

0315	OD	Thread
PL1/8-N00C	1/8"	1/16"
PL5/32-N00C	5/32"	1/16"
PL1/4-N00C	1/4"	1/16"
PL1/8-N01C	1/8"	1/8"
PL5/32-N01C	5/32"	1/8"
PL1/4-N01C	1/4"	1/8"

Tech Sheet 10001

Male Thread, UNF

0315	OD	Thread mm
PL1/8-U10C	1/8"	10-32
PL5/32-U10C	5/32"	10-32
PL1/4-U10C	1/4"	10-32

Tech Sheet 10001



Extended Male Thread, NPT

0315	OD	Thread
PLL1/8-N00C	1/8"	1/16"
PLL5/32-N00C	5/32"	1/16"
PLL1/4-N00C	1/4"	1/16"
PLL1/8-N01C	1/8"	1/8"
PLL5/32-N01C	5/32"	1/8"
PLL1/4-N01C	1/4"	1/8"

Tech Sheet 10001

Extended Male Thread, UNF

0315	OD	Thread mm
PLL1/8-U10C	1/8"	10-32
PLL5/32-U10C	5/32"	10-32
PLL1/4-U10C	1/4"	10-32

Tech Sheet 10001

MICRO ONE TOUCH IMPERIAL NPT & UNF PLASTIC PUSH-IN FITTINGS



Working Temperature:
0°C to +60°C

Maximum Working Pressure:
10 bar (150 psi)

40% less volume and a 20% smaller OD than the standard One Touch design.

Micro One Touch fittings are specially designed for pneumatic systems that are use in confined spaces, saving you time and money on installations.

Male Stud Tees



Branch Male Thread, NPT

0315	OD	Thread
PT1/8-N00C	1/8"	1/16"
PT5/32-N00C	5/32"	1/16"
PT1/4-N00C	1/4"	1/16"
PT1/8-N01C	1/8"	1/8"
PT5/32-N01C	5/32"	1/8"
PT1/4-N01C	1/4"	1/8"

Tech Sheet 10001

Branch Male Thread, UNF

0315	OD	Thread mm
PT1/8-U10C	1/8"	10-32
PT5/32-U10C	5/32"	10-32
PT1/4-U10C	1/4"	10-32

Tech Sheet 10001



Run Male Thread, NPT

0315	OD	Thread
PST1/8-N00C	1/8"	1/16"
PST5/32-N00C	5/32"	1/16"
PST1/4-N00C	1/4"	1/16"
PST1/8-N01C	1/8"	1/8"
PST1/4-N01C	1/4"	1/8"

Tech Sheet 10001

Run Male Thread, UNF

0315	OD	Thread mm
PST1/8-U10C	1/8"	10-32
PST5/32-U10C	5/32"	10-32
PST1/4-U10C	1/4"	10-32

Tech Sheet 10001

Equal Connectors



Straights

0315	OD
PUC1/8C	1/8"
PUC5/32C	5/32"
PUC1/4C	1/4"

Tech Sheet 10001



Elbows

0315	OD
PUL1/8C	1/8"
PUL5/32C	5/32"
PUL1/4C	1/4"

Tech Sheet 10001



Tees

0315	OD
PUT1/8C	1/8"
PUT5/32C	5/32"
PUT1/4C	1/4"

Tech Sheet 10001



Ys

0315	OD
PY5/32C	5/32"
PY1/4C	1/4"

Tech Sheet 10001

Bulkheads



Equal Straights

0315	OD
PMM1/8C	1/8"
PMM5/32C	5/32"
PMM1/4C	1/4"

Tech Sheet 10001



Equal Elbows

0315	OD
PLM1/8C	1/8"
PLM5/32C	5/32"
PLM1/4C	1/4"

Tech Sheet 10001

Speed Control Valves



Male Thread, UNF

0315	OD	Thread mm
NSE1/8-U10C	1/8"	10-32
NSE5/32-U10C	5/32"	10-32
NSE1/4-U10C	1/4"	10-32

Tech Sheet 10001

CHECK & STOP VALVES



Working Temperature:
Brass: 0°C to +60°C
Acetal: 0°C to +60°C



Maximum Working Pressure:
10 bar (150 psi)

Media:
Air and vacuum only.

Negative Pressure:
-750mm Hg (10Torr)

Cracking Pressure:
0.3 bar to 0.5 bar (5 psi to 7.5 psi)

Check Valves

Free flow thread to tube



Tube x BSPT

1060	OD mm	Thread
PCVC04-01	4	1/8"
PCVC04-02	4	1/4"
PCVC06-01	6	1/8"
PCVC06-02	6	1/4"
PCVC08-01	8	1/8"
PCVC08-02	8	1/4"
PCVC10-02	10	1/4"
PCVC10-03	10	3/8"
PCVC12-02	12	1/4"
PCVC12-03	12	3/8"

Tech Sheet 10134



Tube x Tube

1060	OD mm
PCVU04	4
PCVU06	6
PCVU08	8
PCVU10	10

Tech Sheet 10134

Female x Female, BSPT

1060	Thread
PCFF01-01	1/8"
PCFF02-02	1/4"
PCFF03-03	3/8"
PCFF04-04	1/2"

Tech Sheet 10134

Free flow female to male



Male x Female, BSPP

1060	Thread
PCVF01-01	1/8"
PCVF02-02	1/4"
PCVF03-03	3/8"
PCVF04-04	1/2"

Tech Sheet 10134

Stop Valves, Self-sealing



Tube x BSPT

1060	OD mm	Thread
SPC06-02	6	1/4"
SPC08-02	8	1/4"
SPC08-03	8	3/8"
SPC10-02	10	1/4"
SPC10-03	10	3/8"
SPC10-04	10	1/2"
SPC12-03	12	3/8"
SPC12-04	12	1/2"

Tech Sheet 10134



Tube x Tube

1060	OD mm
SPU06	6
SPU08	8
SPU10	10
SPU12	12

Tech Sheet 10134



For **Air Receivers & Accessories**
see pages **433-434**



LF 3000® PUSH-IN FITTINGS

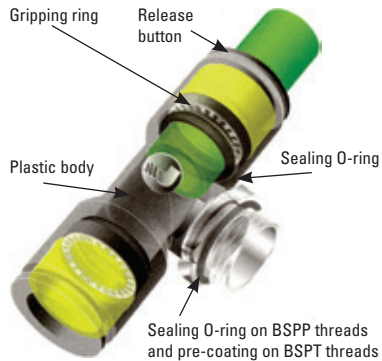

Pre-coated Threads:

All taper threaded LF 3000 male fittings are supplied with a pre-coated thread for immediate installation.



Identification:

The part numbers have been chosen by a method of mnemonics. Each LF 3000 fitting is identified by

- Its series
- The diameter of passage through the fitting
- The thread code or second tube diameter

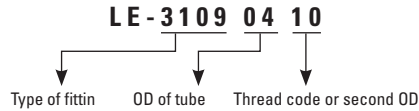

Seals:

All LF 3000 fittings with BSPP and M5 threads are supplied complete with an integral O-ring seal or a pre-assembled nylon sealing washer. This permits instant assembly of the fitting without preparation of the thread, and provides a fixed assembled height to the fitting



Working Temperature:
-20°C to +80°C

Maximum Working Pressure:
20 bar

Vacuum Capability:

Vacuum of 755mm Hg (99% vacuum).

Suitable Fluids:

Compressed air, LF 3000 can also be used for conveying various types of liquids (water, cutting oil, etc) for industrial applications. The working pressure, from 0.6-10 bar and temperatures from 0-60°C, are dependent upon the fluid conveyed and the type of O-ring used. Silicone free.

Male Stud Fittings, Hexagonal



BSPT

1014	OD mm	Thread
LE-3175 04 10	4	1/8"
LE-3175 04 13	4	1/4"
LE-3175 06 10	6	1/8"
LE-3175 06 13	6	1/4"
LE-3175 06 17	6	3/8"
LE-3175 06 21	6	1/2"
LE-3175 08 10	8	1/8"
LE-3175 08 13	8	1/4"
LE-3175 08 17	8	3/8"
LE-3175 08 21	8	1/2"
LE-3175 10 13	10	1/4"
LE-3175 10 17	10	3/8"
LE-3175 10 21	10	1/2"
LE-3175 12 13	12	1/4"
LE-3175 12 17	12	3/8"
LE-3175 12 21	12	1/2"
LE-3175 14 17	14	3/8"
LE-3175 14 21	14	1/2"
LE-3175 16 17	16	3/8"
LE-3175 16 21	16	1/2"

Tech Sheet 10626

Metric & BSPP

1014	OD mm	Thread
LE-3101 03 09	3	M3 x 0.5
LE-3101 03 19	3	M5 x 0.8
LE-3101 04 09	4	M3 x 0.5
LE-3101 04 19	4	M5 x 0.8
LE-3101 04 55	4	M7 x 1
LE-3101 04 13	4	1/4"
LE-3101 06 19	6	M5 x 0.8
LE-3101 06 55	6	M7 x 1
LE-3101 06 10	6	1/8"
LE-3101 06 13	6	1/4"
LE-3101 06 17	6	3/8"
LE-3101 06 21	6	1/2"
LE-3101 08 10	8	1/8"
LE-3101 08 13	8	1/4"
LE-3101 08 17	8	3/8"
LE-3101 10 13	10	1/4"
LE-3101 10 17	10	3/8"
LE-3101 10 21	10	1/2"
LE-3101 12 13	12	1/4"
LE-3101 12 17	12	3/8"
LE-3101 12 21	12	1/2"
LE-3101 14 21	14	1/2"
LE-3101 16 17	16	3/8"
LE-3101 16 21	16	1/2"

Tech Sheet 10626

Female Stud Fittings



Metric & BSPP

1014	OD mm	Thread
LE-3114 04 19	4	M5 x 0.8
LE-3114 04 10	4	1/8"
LE-3114 04 13	4	1/4"
LE-3114 06 10	6	1/8"
LE-3114 06 13	6	1/4"
LE-3114 08 10	8	1/8"
LE-3114 08 13	8	1/4"
LE-3114 08 17	8	3/8"
LE-3114 10 13	10	1/4"
LE-3114 10 17	10	3/8"
LE-3114 10 21	10	1/2"
LE-3114 12 17	12	3/8"
LE-3114 12 21	12	1/2"

Tech Sheet 10626



Partnership brands available



Hydraulic Accumulators & Accessories

See section 1 pages 227-228



Hydraulic Oil Coolers

See section 1 page 273



Pneumatic Quick Release Couplings

See section 3 pages 330-390



Filters & Drains Air, Water & Vacuum

See section 4 page 430



Plastic Push-in Fittings

See section 6 pages 800-803



Ball & Check Valves

See section 5 pages 628



Plastic Push-in Fittings

See section 6 pages 793-807



Metal Push-in Fittings

See section 6 pages 848-851



Ball Valves

See section 7 pages 933-935



Blow Guns

See section 15 page 1596



Aluminium Ring Main Systems

See section 8 pages 1063-1067

ENGINEERING YOUR SUCCESS.

LF 3000® PUSH-IN FITTINGS



Male Stud Elbows



BSPT

1014	OD mm	Thread
LE-3109 04 10	4	1/8"
LE-3109 04 13	4	1/4"
LE-3109 06 10	6	1/8"
LE-3109 06 13	6	1/4"
LE-3109 06 17	6	3/8"
LE-3109 06 21	6	1/2"
LE-3109 08 10	8	1/8"
LE-3109 08 13	8	1/4"
LE-3109 08 17	8	3/8"
LE-3109 08 21	8	1/2"
LE-3109 10 13	10	1/4"
LE-3109 10 17	10	3/8"
LE-3109 10 21	10	1/2"
LE-3109 12 13	12	1/4"
LE-3109 12 17	12	3/8"
LE-3109 12 21	12	1/2"
LE-3109 14 17	14	3/8"
LE-3109 14 21	14	1/2"
LE-3109 16 17	16	3/8"
LE-3109 16 21	16	1/2"

Tech Sheet 10626



Metric & BSPP

1014	OD mm	Thread
LE-3199 03 19	3	M5 x 0.8
LE-3199 04 09	4	M3 x 0.5
LE-3199 04 19	4	M5 x 0.8
LE-3199 04 55	4	M7 x 1
LE-3199 04 10	4	1/8"
LE-3199 04 13	4	1/4"
LE-3199 06 19	6	M5 x 0.8
LE-3199 06 55	6	M7 x 1
LE-3199 06 10	6	1/8"
LE-3199 06 13	6	1/4"
LE-3199 06 17	6	3/8"
LE-3199 06 21	6	1/2"
LE-3199 08 10	8	1/8"
LE-3199 08 13	8	1/4"
LE-3199 08 17	8	3/8"
LE-3199 08 21	8	1/2"
LE-3199 10 13	10	1/4"
LE-3199 10 17	10	3/8"
LE-3199 10 21	10	1/2"
LE-3199 12 13	12	1/4"
LE-3199 12 21	12	1/2"
LE-3199 14 17	14	3/8"
LE-3199 14 21	14	1/2"
LE-3199 16 17	16	3/8"
LE-3199 16 21	16	1/2"

Tech Sheet 10626

Extended Male Stud Elbows



BSPT

1014	OD mm	Thread
LE-3129 04 13	4	1/4"
LE-3129 06 10	6	1/8"
LE-3129 06 13	6	1/4"
LE-3129 08 10	8	1/8"
LE-3129 08 13	8	1/4"
LE-3129 08 17	8	3/8"
LE-3129 10 17	10	3/8"
LE-3129 12 13	12	1/4"
LE-3129 12 17	12	3/8"
LE-3129 12 21	12	1/2"
LE-3129 14 21	14	1/2"

Tech Sheet 10626



Metric & BSPP

1014	OD mm	Thread
LE-3169 04 19	4	M5 x 0.8
LE-3169 04 13	4	1/4"
LE-3169 06 19	6	M5 x 0.8
LE-3169 06 10	6	1/8"
LE-3169 06 13	6	1/4"

Tech Sheet 10626

45° Male Elbows



BSPT

1014	OD mm	Thread
LE-3113 04 10	4	1/8"
LE-3113 06 10	6	1/8"
LE-3113 06 13	6	1/4"
LE-3113 08 13	8	1/4"
LE-3113 08 17	8	3/8"
LE-3113 10 13	10	1/4"
LE-3113 10 17	10	3/8"
LE-3113 12 17	12	3/8"

Tech Sheet 10626



Metric & BSPP

1014	OD mm	Thread
LE-3133 04 19	4	M5 x 0.8
LE-3133 06 19	6	M5 x 0.8
LE-3133 06 10	6	1/8"

Tech Sheet 10626

Female Stud Elbows



BSPP

1014	OD mm	Thread
LE-3192 04 10	4	1/8"
LE-3192 04 13	4	1/4"
LE-3192 06 10	6	1/8"
LE-3192 06 13	6	1/4"
LE-3192 08 10	8	1/8"
LE-3192 08 13	8	1/4"
LE-3192 08 17	8	3/8"
LE-3192 10 13	10	1/4"
LE-3192 10 17	10	3/8"
LE-3192 12 13	12	1/4"
LE-3192 12 17	12	3/8"
LE-3192 12 21	12	1/2"

Tech Sheet 10626



You might also need
Leak-free LIQUIfit Fittings
see pages 800-803

LF 3000® PUSH-IN FITTINGS



Male Stud Branch Tees



BSPT

1014	OD mm	Thread
LE-3108 04 10	4	1/8"
LE-3108 04 13	4	1/4"
LE-3108 06 10	6	1/8"
LE-3108 06 13	6	1/4"
LE-3108 08 10	8	1/8"
LE-3108 08 13	8	1/4"
LE-3108 10 13	10	1/4"
LE-3108 10 17	10	3/8"
LE-3108 10 21	10	1/2"
LE-3108 12 13	12	1/4"
LE-3108 12 17	12	3/8"
LE-3108 12 21	12	1/2"
LE-3108 14 21	14	1/2"
LE-3108 16 17	16	3/8"
LE-3108 16 21	16	1/2"

Tech Sheet 10626

Male Stud Run Tees



BSPT

1014	OD mm	Thread
LE-3103 04 13	4	1/4"
LE-3103 06 10	6	1/8"
LE-3103 08 10	8	1/8"
LE-3103 08 13	8	1/4"
LE-3103 10 13	10	1/4"
LE-3103 10 21	10	1/2"
LE-3103 12 13	12	1/4"
LE-3103 12 17	12	3/8"

Tech Sheet 10626



Metric & BSPP

1014	OD mm	Thread
LE-3193 04 19	4	M5 x 0.8
LE-3193 04 10	4	1/8"
LE-3193 06 19	6	M5 x 0.8
LE-3193 06 10	6	1/8"
LE-3193 08 10	8	1/8"
LE-3193 08 17	8	3/8"
LE-3193 10 13	10	1/4"
LE-3193 12 17	12	3/8"
LE-3193 14 21	14	1/2"

Tech Sheet 10626

Threaded Standpipes



Stem x BSPT

1014	Stem OD mm	Thread
LE-3121 04 13	4	1/4"
LE-3121 06 13	6	1/4"
LE-3121 10 17	10	3/8"

Tech Sheet 10626



Stem x BSPP

1014	Stem OD mm	Thread
LE-3131 08 13	8	1/4"
LE-3131 12 21	12	1/2"
LE-3131 14 17	14	3/8"

Tech Sheet 10626

Double Y Pieces



BSPT

1014	OD mm	Thread
LE-3112 06 13	6	1/4"

Tech Sheet 10626



BSPP

1014	OD mm	Thread
LE-3132 06 13	6	1/4"

Tech Sheet 10626

Twin Banjos



BSPP

1014	OD mm	Thread
LE-3149 04 10	4	1/8"
LE-3149 06 10	6	1/8"
LE-3149 06 13	6	1/4"
LE-3149 08 13	8	1/4"
LE-3149 08 17	8	3/8"

Tech Sheet 10626

Stacking Banjo Bolts



2 Body High Modules BSPP

1014	Thread
LE-3528 00 13	1/4"

Tech Sheet 10626



3 Body High Modules BSPP

1014	Thread
LE-3529 00 10	1/8"
LE-3529 00 13	1/4"

Tech Sheet 10626

Double Banjos



Metric & BSPP

1014	OD mm	Thread
LE-3119 04 19	4	M5 x 0.8
LE-3119 08 13	8	1/4"

Tech Sheet 10626

Single Banjo Bolts



BSPP

1014	Thread
LE-3527 00 10	1/8"
LE-3527 00 13	1/4"
LE-3527 00 17	3/8"

Tech Sheet 10626

Female Threaded Banjo Bolts



BSPP

1014	Thread	Thread
LE-3524 00 10	1/8"	1/8"
LE-3524 00 13	1/4"	1/4"

Tech Sheet 10626

Single Banjo Bodies



BSPP

1014	OD mm	Thread
LE-3538 06 10	6	1/8"
LE-3538 06 13	6	1/4"
LE-3538 08 13	8	1/4"

Tech Sheet 10626

LF 3000® PUSH-IN FITTINGS



Tube/Tube Connectors - Equal & Unequal



Equal

1014	OD mm
LE-3106 03 00	3
LE-3106 04 00	4
LE-3106 06 00	6
LE-3106 08 00	8
LE-3106 10 00	10
LE-3106 12 00	12
LE-3106 14 00	14
LE-3106 16 00	16

Tech Sheet 10626

Unequal

1014	OD mm	OD mm
LE-3106 03 04	3	4
LE-3106 04 06	4	6
LE-3106 04 08	4	8
LE-3106 06 08	6	8
LE-3106 06 10	6	10
LE-3106 08 10	8	10
LE-3106 10 12	10	12
LE-3106 12 14	12	14
LE-3106 12 16	16	12

Tech Sheet 10626

Bulkhead Connectors

All bulkhead fixing nuts are complete with an integral sealing ring for improved performance.



Equal

1014	OD mm
LE-3116 04 00	4
LE-3116 06 00	6
LE-3116 08 00	8
LE-3116 10 00	10
LE-3116 12 00	12
LE-3116 14 00	14

Tech Sheet 10626

Bulkhead Elbows

All bulkhead fixing nuts are complete with an integral sealing ring for improved performance.



Equal

1014	OD mm
LE-3139 04 00	4
LE-3139 06 00	6
LE-3139 08 00	8
LE-3139 10 00	10
LE-3139 12 00	12

Tech Sheet 10626

Single Y Pieces



Equal

1014	OD mm
LE-3140 04 00	4
LE-3140 06 00	6
LE-3140 08 00	8
LE-3140 10 00	10
LE-3140 12 00	12

Tech Sheet 10626

Unequal

1014	OD mm	OD mm
LE-3140 04 06	4	6
LE-3140 06 08	6	8
LE-3140 08 10	8	10
LE-3140 10 12	10	12

Tech Sheet 10626

Elbows



Equal

1014	OD mm
LE-3102 04 00	4
LE-3102 06 00	6
LE-3102 08 00	8
LE-3102 10 00	10
LE-3102 12 00	12
LE-3102 14 00	14
LE-3102 16 00	16

Tech Sheet 10626

Unequal

1014	OD mm	OD mm
LE-3102 04 06	4	6
LE-3102 06 08	6	8
LE-3102 08 10	8	10
LE-3102 10 12	10	12

Tech Sheet 10626

Female Bulkhead Connectors

All bulkhead fixing nuts are complete with an integral sealing ring for improved performance.



BSPP

1014	OD mm	Thread
LE-3136 04 10	4	1/8"
LE-3136 06 10	6	1/8"
LE-3136 06 13	6	1/4"
LE-3136 08 10	8	1/8"
LE-3136 08 13	8	1/4"
LE-3136 10 17	10	3/8"
LE-3136 12 17	12	3/8"

Tech Sheet 10626

Multiple Y Pieces



Equal

1014	OD mm
LE-3144 04 04	4
LE-3144 06 06	6

Tech Sheet 10626

Unequal

1014	OD mm	OD mm
LE-3144 04 06	4	6
LE-3144 06 08	6	8

Tech Sheet 10626

Tees



Equal

1014	OD mm
LE-3104 03 00	3
LE-3104 04 00	4
LE-3104 06 00	6
LE-3104 08 00	8
LE-3104 10 00	10
LE-3104 12 00	12
LE-3104 14 00	14
LE-3104 16 00	16

Tech Sheet 10626

Unequal, Branch

1014	OD mm	OD mm
LE-3104 04 06	4	6
LE-3104 06 04	6	4
LE-3104 06 08	6	8
LE-3104 08 06	8	6
LE-3104 08 10	8	10
LE-3104 10 08	10	8
LE-3104 10 12	10	12
LE-3104 12 10	12	10
LE-3104 16 12	16	12

Tech Sheet 10626

Mixed Bulkhead Connectors

All bulkhead fixing nuts are complete with an integral sealing ring for improved performance.



Push-in x Compression

1014	OD mm
LE-3146 04 00	4
LE-3146 06 00	6

Tech Sheet 10626

LF 3000® PUSH-IN FITTINGS

Unequal Multiple Elbow with Fixing Holes



Reducing Tube x Tube

1014	OD mm	OD mm
LE-3306 06 04	6	4
LE-3306 08 04	8	4
LE-3306 08 06	8	6
LE-3306 10 06	10	6
LE-3306 10 08	10	8

Tech Sheet 10626

Manifold with LF 3000 Push-in Connection



BSPP x Tube

1014	OD mm	Thread
LE-3310 04 13	4	1/4"
LE-3310 06 13	6	1/4"
LE-3310 08 17	8	3/8"

Tech Sheet 10626

Blanking Plugs



Tube

1014	OD mm
LE-3126 04 00	4
LE-3126 06 00	6
LE-3126 08 00	8
LE-3126 10 00	10
LE-3126 12 00	12
LE-3126 14 00	14
LE-3126 16 00	16

Tech Sheet 10626

Plug-in Equal & Unequal Compact Elbow with Plastic Tailpiece



Equal

1014	OD mm
LE-3182 04 00	4
LE-3182 06 00	6
LE-3182 08 00	8
LE-3182 10 00	10
LE-3182 12 00	12

Tech Sheet 10626

Unequal

1014	OD mm	Stem OD mm
LE-3182 04 06	4	6
LE-3182 06 04	6	4
LE-3182 06 08	6	8
LE-3182 08 10	8	10
LE-3182 10 12	10	12

Tech Sheet 10626

Extended Equal & Unequal Elbow with Plastic Tailpiece



Equal

1014	OD mm
LE-3184 12 00	12

Tech Sheet 10626

Unequal

1014	OD mm	Stem OD mm
LE-3184 08 10	8	10

Tech Sheet 10626

45° Equal Elbow with Plastic Tailpiece



Tube x Stem

1014	OD mm
LE-3180 04 00	4
LE-3180 08 00	8

Tech Sheet 10626

Cross Equal



Tube x Tube

1014	OD mm
LE-3107 06 00	6

Tech Sheet 10626

Plug-in Equal Compact Tee with Plastic Tailpiece



Tube x Stem

1014	OD mm
LE-3188 06 00	6
LE-3188 08 00	8

Tech Sheet 10626

Plug-in Equal & Unequal Single Y Piece



Reducing Tube x Stem

1014	OD mm	Stem OD mm
LE-3142 04 06	4	6
LE-3142 06 08	6	8
LE-3142 08 10	8	10

Tech Sheet 10626

Plug-in Equal Tee with Plastic Tailpiece



Tube x Stem

1014	OD mm	Stem OD mm
LE-3183 06 00	6	6
LE-3183 08 00	8	8

Tech Sheet 10626

Plug-in Multiple Y Piece



Tube x Stem

1014	OD mm	Stem OD mm
LE-3143 04 06	4	6

Tech Sheet 10626

Barbed Connector for Unequal Tube



Stem x Hose Tail

1014	Stem OD mm	To Suit Hose OD mm
LE-3122 04 53	4	5
LE-3122 06 05	6	7
LE-3122 08 56	8	6.3
LE-3122 10 08	10	10
LE-3122 12 10	12	12
LE-3122 12 62	12	14.5

Tech Sheet 10626

Double Male Stem Connector - Plastic



Tube x Tube

1014	OD mm
LE-3120 04 00	4
LE-3120 06 00	6
LE-3120 08 00	8
LE-3120 10 00	10

Tech Sheet 10626

Increaser



Tube x Stem

1014	OD mm	Stem OD mm
LE-3168 06 04	6	4
LE-3168 08 06	8	6
LE-3168 10 08	10	8
LE-3168 12 10	12	10

Tech Sheet 10626

LF 3000® PUSH-IN FITTINGS



Reducer



Tube x Stem

1014	OD mm	Stem OD mm
LE-3166 03 04	3	4
LE-3166 04 06	4	6
LE-3166 04 08	4	8
LE-3166 04 10	4	10
LE-3166 06 08	6	8
LE-3166 06 10	6	10
LE-3166 06 12	6	12
LE-3166 06 14	6	14
LE-3166 08 10	8	10
LE-3166 08 12	8	12
LE-3166 08 14	8	14
LE-3166 10 12	10	12
LE-3166 10 14	10	14
LE-3166 12 14	12	14

Tech Sheet 10626

LF 3000 Multi Connectors

The Legris multi connector is designed for simultaneous connection and disconnection of 2, 4, 7 and 12 tubes. Its LF 3000 technology and performance makes it easy to use:- instant connection and disconnection, without tools, - full flow, without restriction. In order to facilitate the installation, each tube outlet is numbered. A location pin avoids assembly errors and a cap helps to guide the tubes and to protect connections. To cover all users needs, this range can also be used for bulkhead connections.



Male Screw Body

1014	OD mm	No of Tubes
LE-3320 04 00 04	4	4
LE-3320 04 00 07	4	7
LE-3320 04 00 12	4	12
LE-3320 06 00 04	6	4
LE-3320 06 00 07	6	7

Tech Sheet 10626



Female Screw Body

1014	OD mm	No of Tubes
LE-3321 04 00 04	4	4
LE-3321 04 00 07	4	7
LE-3321 04 00 12	4	12
LE-3321 06 00 04	6	4
LE-3321 06 00 07	6	7

Tech Sheet 10626



Screw Cap

1014	No of Tubes
LE-3329 00 02	4 and 7

Tech Sheet 10626

DIN Rail Connections

These components are similar in principle to the electrical connectors found in control panels and are used to rationalise cabling and to assist trouble shooting. Used alongside electrical connectors, Legris DIN rail connectors provide similar facilities for pneumatics circuits, and are mounted on the same rail profile which allows electric and pneumatics to run side by side. All tube connections are Legris push-in fittings for plastic tubing



Connector for 2 Tubes In-line

1014	To Suit Hose OD mm
LE-3379 08 00	8

Tech Sheet 10626

Self-Sealing Male Stud Fittings

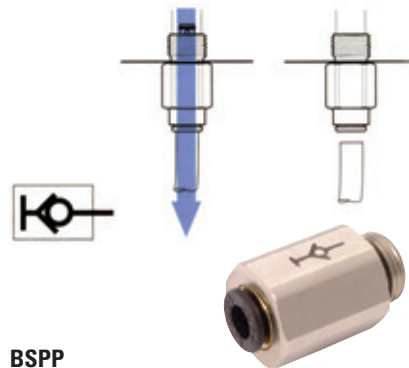

BSPP

1014	OD mm	Thread
LE-3391 04 10	4	1/8"
LE-3391 06 10	6	1/8"
LE-3391 08 13	8	1/4"
LE-3391 10 17	10	3/8"

Tech Sheet 10626

Clip Strips for Tubes



1014	To Suit Hose OD mm
LE-CLIP 04 00	4
LE-CLIP 06 00	6
LE-CLIP 08 00	8
LE-CLIP 10 00	10
LE-CLIP 12 00	12
LE-CLIP 14 00	14

Tech Sheet 10626

Oscillating Compact Elbows

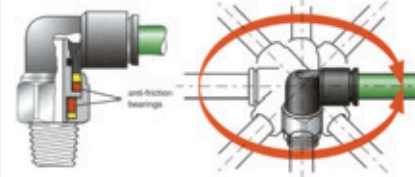

BSPT

1014	OD mm	Thread
LE-3159 04 10	4	1/8"
LE-3159 06 10	6	1/8"
LE-3159 06 13	6	1/4"
LE-3159 08 10	8	1/8"
LE-3159 08 13	8	1/4"

Tech Sheet 10626



Metric & BSPP

1014	OD mm	Thread
LE-3189 04 19	4	M5 x 0.8
LE-3189 06 19	6	M5 x 0.8
LE-3189 06 10	6	1/8"
LE-3189 06 13	6	1/4"
LE-3189 08 10	8	1/8"
LE-3189 08 17	8	3/8"
LE-3189 10 13	10	1/4"
LE-3189 10 17	10	3/8"

Tech Sheet 10626

Coloured Release Button Covers for LF 3000 3rd Generation



1014	OD mm	Colour
LE-3110 14 00	14	White
LE-3110 14 02	14	Green
LE-3110 06 03	6	Red
LE-3110 14 03	14	Red
LE-3110 04 04	4	Blue
LE-3110 06 04	6	Blue
LE-3110 12 04	12	Blue
LE-3110 14 04	14	Blue
LE-3110 14 05	14	Yellow

Tech Sheet 10626

LEAK-FREE, PUSH-IN FITTINGS NPT THREADS X IMPERIAL TUBE

Introducing LIQUIfi™ a range of leak-free, push-in fittings in a bio-based compact body.

LIQUIfi™ offers:

- The most compact profile on the market
- EPDM patented sealing technology
- Full flo
- No pumping effect
- No need for locking clip or tube insert
- Optimum performance suitable for food and water contact
- 100% bio-based body and base



Working Temperature:

1/4"	+2°C to +38°C +65°C +93°C
3/8"	+2°C to +38°C +65°C +93°C
1/2"	+2°C to +38°C +65°C +93°C



Maximum Working Pressure:

16 bar
10 bar
6 bar
13 bar
7 bar
4 bar
11 bar
7 bar
4 bar

Suitable for use with chemicals and other potentially aggressive liquids.
Please contact our technical department for full details.



Male Stud Fittings



Hexagonal, NPT

1014	OD	Thread
LE-6305 56 14W	1/4"	1/4"

Tech Sheet 10625

Female Stud Fittings



NPT

1014	OD	Thread
LE-6315 56 14W	1/4"	1/4"
LE-6315 60 18W	3/8"	3/8"

Tech Sheet 10625

Tees



Equal

1014	OD
LE-6304 56 00W	1/4"
LE-6304 60 00W	3/8"
LE-6304 62 00W	1/2"

Tech Sheet 10625

Equal Elbows



Tube x Tube

1014	OD
LE-6302 56 00W	1/4"
LE-6302 60 00W	3/8"
LE-6302 62 00W	1/2"

Tech Sheet 10625

Straight Connectors



Equal, Tube x Tube

1014	OD
LE-6306 56 00W	1/4"
LE-6306 60 00W	3/8"
LE-6306 62 00W	3/8"

Tech Sheet 10625

Tube/Tube Connectors



Unequal, Tube x Tube

1014	OD	OD
LE-6306 56 60W	1/4"	3/8"
LE-6306 60 62W	3/8"	1/2"

Tech Sheet 10625

Bulkhead Connectors



Tube x Tube

1014	OD
LE-6316 56 00W	1/4"
LE-6316 60 00W	3/8"
LE-6316 62 00W	1/2"

Tech Sheet 10625

Single Y Pieces



Tube x Tube

1014	OD
LE-6340 56 00W	1/4"
LE-6340 60 00W	3/8"
LE-6340 62 00W	1/2"

Tech Sheet 10625

Tube Blanking Caps



Tube

1014	OD
LE-6351 56 00W	1/4"
LE-6351 60 00W	3/8"

Tech Sheet 10625

LEAK-FREE, PUSH-IN FITTINGS NPT THREADS X IMPERIAL TUBE



Connectors



Tube x Hose Tail

1014	Stem OD	To Suit Hose ID
LE-6322 56 56W	1/4"	0.28
LE-6322 60 56W	3/8"	0.28
LE-6322 60 08W	3/8"	0.33
LE-6322 60 60W	3/8"	0.4
LE-6322 62 60W	1/2"	0.4

Tech Sheet 10625

Plugs



Tube

1014	OD
LE-6326 56 00W	1/4"

Tech Sheet 10625

Acetal Check Valves



Tube x Tube

1014	OD
LE-7992 56 00W	1/4"
LE-7992 60 00W	3/8"

Tech Sheet 10625

Tank Ball Valves



Tube x Female, NPT

1014	OD	Thread
LE-4022 56 14W	1/4"	1/4"
LE-4022 60 18W	3/8"	3/8"

Tech Sheet 10625

In-line Ball Valves



Tube x Tube

1014	OD
LE-4020 56 00W	1/4"
LE-4020 60 00W	3/8"

Tech Sheet 10625



Tube x Male, NPT

1014	OD	Thread
LE-4021 56 14W	1/4"	1/4"
LE-4021 60 18W	3/8"	3/8"

Tech Sheet 10625

Reducers



Tube x Stem

1014	OD	Stem OD
LE-6366 56 08W	1/4"	5/16"
LE-6366 56 60W	1/4"	3/8"
LE-6366 60 62W	3/8"	1/2"

Tech Sheet 10625

Plug-in Equal Compact Elbows



Tube x Stem

1014	OD
LE-6382 56 00W	1/4"
LE-6382 60 00W	3/8"
LE-6382 62 00W	1/2"

Tech Sheet 10625

Plug-in Equal Branch Tees



Tube x Stem

1014	OD
LE-6388 56 00W	1/4"
LE-6388 60 00W	3/8"

Tech Sheet 10625

LEAK-FREE, PUSH-IN FITTINGS BSP THREADS X METRIC TUBE



Male Stud Fittings



BSPT

1014	OD mm	Thread
LE-6505 04 10W	4	1/8"
LE-6505 04 13W	4	1/4"
LE-6505 06 10W	6	1/8"
LE-6505 06 13W	6	1/4"
LE-6505 08 10W	8	1/8"
LE-6505 08 13W	8	1/4"
LE-6505 08 17W	8	3/8"
LE-6505 10 13W	10	1/4"
LE-6505 10 17W	10	3/8"
LE-6505 10 21W	10	1/2"
LE-6505 12 17W	12	3/8"
LE-6505 12 21W	12	1/2"

Tech Sheet 10625

Female Stud Fittings



BSPT

1014	OD mm	Thread
LE-6315 06 10W	6	1/8"
LE-6315 06 13W	6	1/4"
LE-6315 08 13W	8	1/4"
LE-6315 08 17W	8	3/8"

Tech Sheet 10625

Fixed Male Stud Elbows



BSPT

1014	OD mm	Thread
LE-6579 06 10W	6	1/8"
LE-6579 06 13W	6	1/4"
LE-6579 06 17W	6	3/8"

Tech Sheet 10625

Swivel Male Stud Fittings



BSPT

1014	OD mm	Thread
LE-6509 06 10W	6	1/8"
LE-6509 06 13W	6	1/4"
LE-6509 06 17W	6	3/8"
LE-6509 08 10W	8	1/8"
LE-6509 08 13W	8	1/4"
LE-6509 08 17W	8	3/8"
LE-6509 10 13W	10	1/4"
LE-6509 10 17W	10	3/8"
LE-6509 10 21W	10	1/2"
LE-6509 12 17W	12	3/8"
LE-6509 12 21W	12	1/2"

Tech Sheet 10625

Tees



Equal

1014	OD mm
LE-6304 04 00W	4
LE-6304 06 00W	6
LE-6304 08 00W	8
LE-6304 10 00W	10
LE-6304 12 00W	12

Tech Sheet 10625

Swivel Branch Tees



BSPT

1014	OD mm	Thread
LE-6508 06 10W	6	1/8"
LE-6508 06 13W	6	1/4"
LE-6508 06 17W	6	3/8"
LE-6508 08 13W	8	1/4"
LE-6508 08 17W	8	3/8"
LE-6508 10 13W	10	1/4"
LE-6508 10 17W	10	3/8"
LE-6508 10 21W	10	1/2"
LE-6508 12 17W	12	3/8"
LE-6508 12 21W	12	1/2"

Tech Sheet 10625

Swivel Male Run Tees



BSPT

1014	OD mm	Thread
LE-6503 06 13W	6	1/4"
LE-6503 08 10W	8	1/8"
LE-6503 08 13W	8	1/4"
LE-6503 08 17W	8	3/8"
LE-6503 12 17W	12	3/8"
LE-6503 12 21W	12	1/2"

Tech Sheet 10625

Stem Adaptors



BSPT

1014	OD mm	Thread
LE-6521 06 10W	6	1/8"
LE-6521 06 13W	6	1/4"
LE-6521 06 17W	6	3/8"
LE-6521 08 10W	8	1/8"
LE-6521 08 13W	8	1/4"
LE-6521 08 17W	8	3/8"
LE-6521 10 13W	10	1/4"
LE-6521 10 17W	10	3/8"
LE-6521 10 21W	10	1/2"
LE-6521 12 17W	12	3/8"
LE-6521 12 21W	12	1/2"

Tech Sheet 10625

LEAK-FREE, PUSH-IN FITTINGS



Equal Elbows



Tube x Tube

1014	OD mm
LE-6302 04 00W	4
LE-6302 06 00W	6
LE-6302 08 00W	8
LE-6302 10 00W	10
LE-6302 12 00W	12

Tech Sheet 10625

Single Y Pieces



Tube x Tube

1014	OD mm
LE-6340 04 00W	4
LE-6340 06 00W	6
LE-6340 08 00W	8
LE-6340 10 00W	10
LE-6340 12 00W	12

Tech Sheet 10625

Plug-in Equal Compact Elbows



Tube x Stem

1014	OD mm
LE-6382 04 00W	4
LE-6382 06 00W	6
LE-6382 08 00W	8
LE-6382 10 00W	10
LE-6382 12 00W	12

Tech Sheet 10625

Straight Connectors



Equal, Tube x Tube

1014	OD mm
LE-6306 04 00W	4
LE-6306 06 00W	6
LE-6306 08 00W	8
LE-6306 10 00W	10
LE-6306 12 00W	12

Tech Sheet 10625

Tube Blanking Caps



Tube

1014	OD mm
LE-6351 04 00W	4
LE-6351 06 00W	6
LE-6351 08 00W	8
LE-6351 10 00W	10
LE-6351 12 00W	12

Tech Sheet 10625

Plug-in Equal Branch Tees



Tube x Stem

1014	OD mm
LE-6388 04 00W	4
LE-6388 06 00W	6
LE-6388 08 00W	8
LE-6388 10 00W	10

Tech Sheet 10625

Bulkhead Connectors



Tube x Tube

1014	OD mm
LE-6316 04 00W	4
LE-6316 06 00W	6
LE-6316 08 00W	8
LE-6316 10 00W	10
LE-6316 12 00W	12

Tech Sheet 10625

Reducers



Tube x Stem

1014	OD mm	Stem OD mm
LE-6366 04 06W	4	6
LE-6366 06 08W	6	8
LE-6366 08 10W	8	10

Tech Sheet 10625

Plugs



Tube

1014	OD mm
LE-6326 04 00W	4
LE-6326 06 00W	6
LE-6326 08 00W	8
LE-6326 10 00W	10
LE-6326 12 00W	12

Tech Sheet 10625

FLOW CONTROL REGULATORS POLYMER VERSION



Miniature

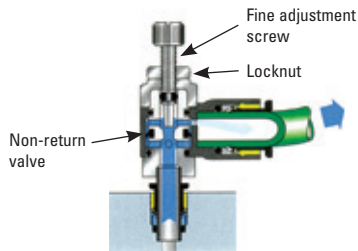

Compact

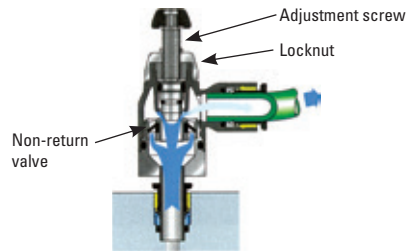

Working Temperature:
0°C to +70°C

Working Pressure:
1 to 10 bar

Working Fluids:
Compressed air

Identification:

The part numbers have been chosen by a method of mnemonics. Each item is identified by

- Its series
- The diameter of passage through the fitting
- The thread code or second tube diameter

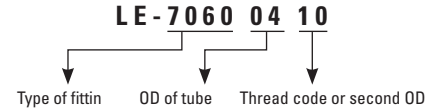

Compact



Exhaust Version (A), BSPP

1012	OD mm	Thread
LE-7060 06 10	6	1/8"
LE-7060 06 13	6	1/4"
LE-7060 08 10	8	1/8"
LE-7060 08 13	8	1/4"
LE-7060 08 17	8	3/8"
LE-7060 10 13	10	1/4"
LE-7060 10 17	10	3/8"
LE-7060 12 17	12	3/8"
LE-7060 12 21	12	1/2"

Tech Sheet 10627



Supply Version (B), BSPP

1012	OD mm	Thread
LE-7061 04 10	4	1/8"
LE-7061 06 10	6	1/8"
LE-7061 06 13	6	1/4"
LE-7061 08 13	8	1/4"
LE-7061 08 17	8	3/8"
LE-7061 10 17	10	3/8"
LE-7061 12 21	12	1/2"

Tech Sheet 10627



Bi-directional Version (C), BSPP

1012	OD mm	Thread
LE-7062 04 10	4	1/8"
LE-7062 06 10	6	1/8"
LE-7062 06 13	6	1/4"
LE-7062 08 10	8	1/8"
LE-7062 08 13	8	1/4"

Tech Sheet 10627

Miniature



Exhaust Version (A), Metric & BSPP

1012	OD mm	Thread
LE-7660 03 19	3	M5 x 0.8
LE-7660 04 19	4	M5 x 0.8
LE-7660 04 10	4	1/8"
LE-7660 06 19	6	M5 x 0.8
LE-7660 06 10	6	1/8"
LE-7660 06 13	6	1/4"
LE-7660 08 10	8	1/8"
LE-7660 08 13	8	1/4"
LE-7660 08 17	8	3/8"

Tech Sheet 10627



Supply Version (B), Metric & BSPP

1012	OD mm	Thread
LE-7669 03 09	3	M3 x 0.5
LE-7669 04 19	4	M5 x 0.8
LE-7669 04 10	4	1/8"
LE-7669 06 19	6	M5 x 0.8
LE-7669 06 10	6	1/8"
LE-7669 08 13	8	1/4"

Tech Sheet 10627

Plug-in Compact



Exhaust Version (A)

1012	OD mm
LE-7030 08 00	8

Tech Sheet 10627

Supply Version (B)

1012	OD mm
LE-7031 06 00	6
LE-7031 08 00	8

Tech Sheet 10627

FLOW CONTROL REGULATORS POLYMER VERSION

In-line Panel Mountable with LF 3000 Push-in Connections



One Way Adjustment (A), for Nylon PU Tubing

1012	OD mm
LE-7776 04 00	4
LE-7776 06 00	6
LE-7776 08 00	8
LE-7776 10 00	10
LE-7776 12 00	12

In-line with LF 3000 Push-in Connections



One Way Adjustment (A), for Nylon and PU Tubing

1012	OD mm
LE-7770 04 00	4
LE-7770 06 00	6
LE-7770 08 00	8
LE-7770 10 00	10
LE-7770 12 00	12

Bi-directional (C)

1012	OD mm
LE-7772 04 00	4
LE-7772 06 00	6
LE-7772 08 00	8

Compact Swivel Outlet



Exhaust Version (A), BSPP

1012	OD mm	Thread
LE-7740 06 10	6	1/8"
LE-7040 08 10	8	1/8"

Tech Sheet 10627

Exhaust Version (A), BSPT

1012	OD mm	Thread
LE-7045 08 17	8	3/8"

In-line with Threaded Connections



One Way Adjustment (C), Panel Mountable, BSPP

1012	Thread
LE-7771 10 10	1/8"
LE-7771 13 13	1/4"
LE-7771 17 17	3/8"
LE-7771 21 21	1/2"

Miniature Swivel Outlet



Supply Version (B), Metric & BSPP

1012	OD mm	Thread
LE-7649 04 19	4	M5 x 0.8
LE-7649 06 19	6	M5 x 0.8
LE-7649 06 10	6	1/8"



Compact, with Recessed Adjustment Screw



Exhaust Version (A), Metric & BSPP

1012	OD mm	Thread
LE-7010 04 19	4	M5 x 0.8
LE-7010 04 10	4	1/4"
LE-7010 06 19	6	M5 x 0.8
LE-7010 06 10	6	1/8"
LE-7010 06 13	6	1/4"
LE-7010 08 10	8	1/8"
LE-7010 08 13	8	1/4"
LE-7010 10 13	10	1/4"
LE-7010 10 17	10	3/8"

Supply Version (B), Metric & BSPP

1012	OD mm	Thread
LE-7011 06 19	6	M5 x 0.8
LE-7011 06 10	6	1/8"
LE-7011 06 13	6	1/4"
LE-7011 08 13	8	1/4"
LE-7011 10 13	10	1/4"

Bi-directional (C), Metric



1012	OD mm	Thread
LE-7012 04 19	4	M5 x 0.8

Metal Body with LF 3000 Instant Fittings

 Flow Control Regulators Metal Version
Working Temperature:
0°C to +70°C



Exhaust Flow Control, BSPP

1012	OD mm	Thread
LE-7100 06 13	6	1/4"
LE-7100 08 10	8	1/8"
LE-7100 08 13	8	1/4"
LE-7100 12 21	12	1/2"
LE-7100 14 21	14	1/2"

Supply Flow Control, BSPP

1012	OD mm	Thread
LE-7101 06 13	6	1/4"

FLOW CONTROL REGULATORS & FUNCTION FITTINGS

Metal Body with Threaded Fittings

Exhaust Flow Control, BSPP

1012	Thread
LE-7110 13 13	1/4"
LE-7110 17 17	3/8"
LE-7110 21 21	1/2"



Supply Flow Control, BSPP

1012	Thread
LE-7111 13 13	1/4"

Blocking Fittings: Which are mounted in pairs in a cylinder-lock the piston by simultaneously cutting off the supply and exhaust. Functional locks are more precise and rapid when blocking fittings are located on the cylinder: the volume of air in the supply line no longer needs to be taken into consideration.

Male Thread BSPP

Working Temperature:
-20°C to +70°C

No. of Cycles:
10 million at 20°C and 1 Hz

Body: Treated brass

Working Pressure:
1 to 10 bar



With LF 3000 Instant Fittings, BSPP

1012	Thread A mm	Thread B mm	Thread
LE-7880 06 10	6	4	1/8"
LE-7880 06 13	6	4	1/4"
LE-7880 08 13	8	4	1/4"
LE-7880 08 17	8	4	3/8"
LE-7880 10 17	10	4	3/8"
LE-7880 12 21	12	4	1/2"

With Threaded Connection

1012	OD A mm	OD B mm	Thread
LE-7881 13 10	1/8"	M5	1/4"
LE-7881 13 13	1/4"	M5	1/4"
LE-7881 17 17	3/8"	M5	3/8"
LE-7881 21 21	1/2"	M5	1/2"

Blocker/Flow Regulator

Working Temperature:
-15°C to +60°C

Body: Polymer HR/brass body with captive seal. This fitting combines the functions of blocking and flow regulation, saving space and installing time

With LF 3000 Instant Fittings, BSPP

1012	OD A mm	OD B mm	Thread
LE-7883 06 10	6	4	1/8"
LE-7883 06 13	6	4	1/4"
LE-7883 08 13	8	4	1/4"



Push-in Connectors

Supply Version, BSPP

1012	OD mm	Thread
LE-7984 06 10	6	1/8"
LE-7984 06 13	6	1/4"
LE-7984 08 10	8	1/8"
LE-7984 08 13	8	1/4"



Supply Version, BSPT

1012	OD mm	Thread
LE-7985 06 13	6	1/4"
LE-7985 08 13	8	1/4"



Miniature with Push-in Connection

Exhaust Version, Metric & BSPP

1012	OD mm	Thread
LE-7180 04 19	4	M5 x 0.8
LE-7180 04 10	4	1/8"
LE-7180 06 10	6	1/8"
LE-7180 08 10	8	1/8"



Miniature with Threaded Fitting

Exhaust Version, Metric & BSPP

1012	Thread
LE-7190 19 19	M5 x 0.8
LE-7190 10 10	1/8"



Recessed Adjustment Screw

Push-in, Exhaust Version, Metric & BSPP

1012	OD mm	Thread
LE-7130 04 19	4	M5 x 0.8
LE-7130 04 10	4	1/8"
LE-7130 06 19	6	M5 x 0.8
LE-7130 06 10	6	1/8"
LE-7130 06 13	6	1/4"
LE-7130 08 10	8	1/8"
LE-7130 08 13	8	1/4"
LE-7130 08 17	8	3/8"
LE-7130 10 13	10	1/4"
LE-7130 10 17	10	3/8"
LE-7130 12 17	12	3/8"
LE-7130 12 21	12	1/2"



Threaded Fitting, Exhaust Version, Metric & BSPP

1012	Thread
LE-7140 19 19	M5 x 0.8
LE-7140 10 10	1/8"
LE-7140 13 13	1/4"
LE-7140 17 17	3/8"
LE-7140 21 21	1/2"



Threaded Fitting, Exhaust Version, BSPP

1012	Thread
LE-7810 13 13	1/4"
LE-7810 17 17	3/8"



Threaded Fitting, Bi-directional, BSPP

1012	Thread
LE-7812 10 10	1/8"
LE-7812 13 13	1/4"



FLOW CONTROL REGULATORS & FUNCTION FITTINGS



Pilot Operated Vent Fittings

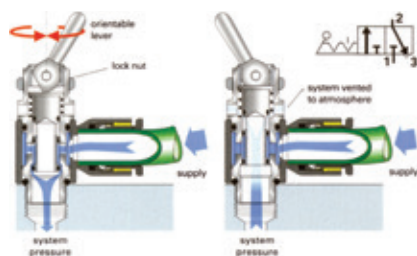

Male Thread, with Push-in Connection, BSPP

1012	OD mm	Thread
LE-7800 04 10	4	1/8"
LE-7800 06 10	6	1/8"
LE-7800 06 13	6	1/4"
LE-7800 08 13	8	1/4"

Tech Sheet 10628



2/2 Manual Switch Operated Valve, BSPP

1012	OD mm	Thread
LE-7802 06 10	6	1/8"
LE-7802 06 13	6	1/4"
LE-7802 08 10	8	1/8"
LE-7802 08 13	8	1/4"

Tech Sheet 10628

Pneumatic Sensor Fittings

Working Temperature: -15°C to +60°C
 Breaking Pressure: 0.6 bar
 Response Time: 3ms

Working Pressure: 3 to 8 bar



With LF 3000 Push-in Fittings for Nylon and PU Tubing, Metric & BSPP

1012	OD mm	Thread
LE-7818 04 19	4	M5 x 0.8
LE-7818 04 10	4	1/8"
LE-7818 04 13	4	1/4"
LE-7818 04 17	4	3/8"
LE-7818 04 21	4	1/2"

Tech Sheet 10632



Threaded Fittings, Metric & BSPP

1012	Thread	Thread
LE-7818 19 10	1/8"	M5
LE-7818 19 13	1/4"	M5

Tech Sheet 10632

In-line Non-return Valve

With LF 3000 Push-in Connector



1012	OD mm
LE-7996 04 00	4
LE-7996 06 00	6
LE-7996 08 00	8
LE-7996 10 00	10
LE-7996 12 00	12

Piloted Non-return Valves



BSPP

1012	OD mm	Thread
LE-7892 06 10	6	1/8"
LE-7892 08 10	8	1/8"
LE-7892 06 13	6	1/4"
LE-7892 08 13	8	1/4"
LE-7892 08 17	8	3/8"

Tech Sheet 10661

Piloted Non-return, Regulator & Exhaust



BSPP

1012	OD mm	Thread
LE-7894 06 10	6	1/8"
LE-7894 08 10	8	1/8"
LE-7894 06 13	6	1/4"
LE-7894 08 13	8	1/4"
LE-7894 08 17	8	3/8"

Tech Sheet 10661

SNAP CONNECTORS



Body with LF 3000 Connection



1012	OD A mm	OD B mm
LE-7926 05 06	6	5
LE-7926 05 08	8	5
LE-7926 07 10	10	7,3

Tech Sheet 10629

Probe with LF 3000 Connection



1012	OD A mm	OD B mm
LE-7960 05 06	6	5
LE-7960 05 08	8	5
LE-7960 07 10	10	7,3

Tech Sheet 10629

QS, STANDARD SERIES PUSH-IN FITTINGS

 **Ambient Temperature:**
-10°C to +80°C

 **Temperature Dependent Operating Pressure:**
- 0.95 to 6 bar at 80°C
- 0.95 to 14 bar at 20°C

- Simple and reliable connection and release
- Wide range of variants: large selection for maximum flexibility in standard applications

- PBT housing, POM release ring, NBR tube seal
- Operating media: compressed air, vacuum, (water as per manufacturer's declaration)

Male Studs



Male Thread, BSPP

0009	OD mm	Thread	Quantity	Manufacturer's Code
186106	4	G1/8"	10	QS-G1/8-4-I
186107	6	G1/8"	10	QS-G1/8-6-I
186109	8	G1/8"	10	QS-G1/8-10-I
186108	6	G1/4"	10	QS-G1/4-6-I
186110	8	G1/4"	10	QS-G1/4-8-I
186111	8	G3/8"	10	QS-G3/8-8-I
132999	10	G1/8"	10	QS-G3/8-10-I
186112	10	G1/4"	10	QS-G3/8-12-I
186113	10	G3/8"	10	QS-G1/2-12-I
186114	12	G3/8"	10	QS-G1/8-8-I
186115	12	G1/2"	1	QS-G1/4-10-I

Tech Sheet 70377



Male Thread, BSPT

0009	OD mm	Thread	Quantity	Manufacturer's Code
153012	4	R1/8"	10	QS-1/8-4-I
153013	6	R1/8"	10	QS-1/8-6-I
153014	6	R1/4"	10	QS-1/4-6-I
153015	8	R1/8"	10	QS-1/8-8-I
153016	8	R1/4"	10	QS-1/4-8-I
153017	8	R3/8"	10	QS-3/8-8-I
190647	10	R1/8"	10	QS-1/8-10-I
153018	10	R1/4"	10	QS-1/4-10-I
153019	10	R3/8"	10	QS-3/8-10-I
190648	10	R1/2"	1	QS-1/2-10-I
190649	12	R1/4"	10	QS-1/4-12-I
153020	12	R3/8"	10	QS-3/8-12-I
153021	12	R1/2"	1	QS-1/2-12-I

Tech Sheet 70380



Male Thread, BSPP (Hex Body)

0009	OD mm	Thread	Quantity	Manufacturer's Code
186095	4	G1/8"	10	QS-G1/8-4
186096	6	G1/8"	10	QS-G1/8-6
186097	6	G1/4"	10	QS-G1/4-6
186098	8	G1/8"	10	QS-G1/8-8
186099	8	G1/4"	10	QS-G1/4-8
186100	8	G3/8"	10	QS-G3/8-8
186101	10	G1/4"	10	QS-G1/4-10
186102	10	G3/8"	10	QS-G3/8-10
186350	12	G1/4"	10	QS-G1/4-12
186103	12	G3/8"	10	QS-G3/8-12
186104	12	G1/2"	1	QS-G1/2-12

Tech Sheet 70379



Male Thread, BSPT (Hex Body)

0009	OD mm	Thread	Quantity	Manufacturer's Code
153001	4	R1/8"	10	QS-1/8-4
190644	4	R1/4"	10	QS-1/4-4
153002	6	R1/8"	10	QS-1/8-6
153003	6	R1/4"	10	QS-1/4-6
190645	6	R3/8"	10	QS-3/8-6
153004	8	R1/8"	10	QS-1/8-8
153005	8	R1/4"	10	QS-1/4-8
153006	8	R3/8"	10	QS-3/8-8
190643	10	R1/8"	10	QS-1/8-10
153007	10	R1/4"	10	QS-1/4-10
153008	10	R3/8"	10	QS-3/8-10
190646	10	R1/2"	1	QS-1/2-10
164980	12	R1/4"	10	QS-1/4-12
153009	12	R3/8"	10	QS-3/8-12
153010	12	R1/2"	1	QS-1/2-12

Tech Sheet 70378

Female Studs



Female Thread, BSPT

0009	OD mm	Thread	Quantity	Manufacturer's Code
153022	4	R1/8"	10	QSF-1/8-4-B
130709	4	R1/8"	100	QSF-1/8-4-B-100
190650	4	R1/4"	10	QSF-1/4-4-B
153023	6	R1/8"	10	QSF-1/8-6-B
130712	6	R1/4"	100	QSF-1/4-6-B-100
130710	6	R1/8"	100	QSF-1/8-6-B-100
153024	6	R1/4"	10	QSF-1/4-6-B
190652	6	R3/8"	10	QSF-3/8-6-B
153025	8	R1/8"	10	QSF-1/8-8-B
130711	8	R1/8"	50	QSF-1/8-8-B-50
153026	8	R1/4"	10	QSF-1/4-8-B
130713	8	R1/4"	50	QSF-1/4-8-B-50
153027	8	R3/8"	10	QSF-3/8-8-B
130715	8	R3/8"	50	QSF-3/8-8-B-50
153028	10	R1/4"	10	QSF-1/4-10-B
130714	10	R1/4"	50	QSF-1/4-10-B-50
153029	10	R3/8"	10	QSF-3/8-10-B
130716	10	R3/8"	50	QSF-3/8-10-B-50
190651	12	R1/4"	10	QSF-1/4-12-B
153030	12	R3/8"	10	QSF-3/8-12-B
130717	12	R3/8"	20	QSF-3/8-12-B-20
190653	12	R1/2"	1	QSF-1/2-12-B
190654	16	R1/2"	1	QSF-1/2-16-B

Tech Sheet 70384

FESTO

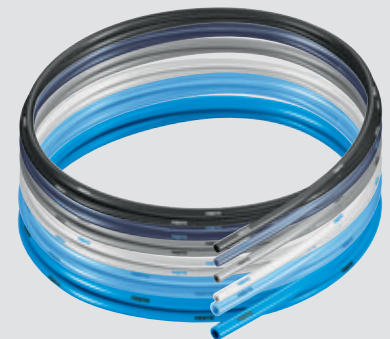

You might also need
Polyurethane Tubing
see pages 911-912

QS, STANDARD SERIES PUSH-IN FITTINGS

FESTO

 **Ambient Temperature:**
-10°C to +80°C

 **Temperature Dependant Operating Pressure:**
- 0.95 to 6 bar at 80°C
- 0.95 to 14 bar at 20°C

- Simple and reliable connection and release
- Wide range of variants: large selection for maximum flexibility in standard applications

- PBT housing, POM release ring, NBR tube seal
- Operating media: compressed air, vacuum, (water as per manufacturer's declaration)

Male Stud 90° Elbows



Male Thread, BSPP

0009	OD mm	Thread	Quantity	Manufacturer's Code
186116	4	G1/8"	10	QSL-G1/8-4
186117	6	G1/8"	10	QSL-G1/8-6
186118	6	G1/4"	10	QSL-G1/4-6
186119	8	G1/8"	10	QSL-G1/8-8
186120	8	G1/4"	10	QSL-G1/4-8
186121	8	G3/8"	10	QSL-G3/8-8
186122	10	G1/4"	10	QSL-G1/4-10
186123	10	G3/8"	10	QSL-G3/8-10
186351	12	G1/4"	10	QSL-G1/4-12
186124	12	G3/8"	10	QSL-G3/8-12
186125	12	G1/2"	1	QSL-G1/2-12

Tech Sheet 70385



Male Thread, BSPT

0009	OD mm	Thread	Quantity	Manufacturer's Code
153045	4	R1/8"	10	QSL-1/8-4
190659	4	R1/4"	10	QSL-1/4-4
153046	6	R1/8"	10	QSL-1/8-6
153047	6	R1/4"	10	QSL-1/4-6
190660	6	R3/8"	10	QSL-3/8-6
153048	8	R1/8"	10	QSL-1/8-8
153049	8	R1/4"	10	QSL-1/4-8
153050	8	R3/8"	10	QSL-3/8-8
190658	10	R1/8"	10	QSL-1/8-10
153051	10	R1/4"	10	QSL-1/4-10
153052	10	R3/8"	10	QSL-3/8-10
190661	10	R1/2"	1	QSL-1/2-10
164981	12	R1/4"	10	QSL-1/4-12
153053	12	R3/8"	10	QSL-3/8-12
153054	12	R1/2"	1	QSL-1/2-12

Tech Sheet 70386

Male Stud 90° Extended Elbows



Male Thread, BSPT

0009	OD mm	Thread	Quantity	Manufacturer's Code
153076	4	R1/8"	10	QSL-1/8-4
190662	4	R1/4"	10	QSL-1/4-4
153077	6	R1/8"	10	QSL-1/8-6
153078	6	R1/4"	10	QSL-1/4-6
190663	6	R3/8"	10	QSL-3/8-6
153079	8	R1/8"	10	QSL-1/8-8
153080	8	R1/4"	10	QSL-1/4-8
153081	8	R3/8"	10	QSL-3/8-8
153082	10	R1/4"	10	QSL-1/4-10
153083	10	R3/8"	10	QSL-3/8-10
190664	10	R1/2"	1	QSL-1/2-10
153084	12	R3/8"	10	QSL-3/8-12
153085	12	R1/2"	1	QSL-1/2-12

Tech Sheet 70393

Female Stud 90° Elbows



Female Thread, BSPT

0009	OD mm	Thread	Quantity	Manufacturer's Code
153273	4	R1/8"	10	QSLF-1/8-4-B
153274	6	R1/8"	10	QSLF-1/8-6-B
153275	6	R1/4"	10	QSLF-1/4-6-B
153276	8	R1/8"	10	QSLF-1/8-8-B
153277	8	R1/4"	10	QSLF-1/4-8-B
153278	8	R3/8"	10	QSLF-3/8-8-B
153279	10	R1/4"	10	QSLF-1/4-10-B
153280	10	R3/8"	10	QSLF-3/8-10-B

Tech Sheet 70387

Male Stud Tees



Branch Male Thread, BSPT

0009	OD mm	Thread	Quantity	Manufacturer's Code
153106	4	R1/8"	10	QST-1/8-4
190668	4	R1/4"	10	QST-1/4-4
153107	6	R1/8"	10	QST-1/8-6
153108	6	R1/4"	10	QST-1/4-6
190670	6	R3/8"	10	QST-3/8-6
153109	8	R1/8"	10	QST-1/8-8
153110	8	R1/4"	10	QST-1/4-8
153111	8	R3/8"	10	QST-3/8-8
190667	10	R1/8"	10	QST-1/8-10
153112	10	R1/4"	10	QST-1/4-10
153113	10	R3/8"	10	QST-3/8-10
190672	10	R1/2"	1	QST-1/2-10
190669	12	R1/4"	10	QST-1/4-12
153114	12	R3/8"	10	QST-3/8-12
153115	12	R1/2"	1	QST-1/2-12

Tech Sheet 70395

Run Male Thread, BSPT



0009	OD mm	Thread	Quantity	Manufacturer's Code
153117	4	R1/8"	10	QSTL-1/8-4
153118	6	R1/8"	10	QSTL-1/8-6
153119	6	R1/4"	10	QSTL-1/4-6
153120	8	R1/8"	10	QSTL-1/8-8
153121	8	R1/4"	10	QSTL-1/4-8
153122	8	R3/8"	10	QSTL-3/8-8
153123	10	R1/4"	10	QSTL-1/4-10
153124	10	R3/8"	10	QSTL-3/8-10
153125	12	R3/8"	10	QSTL-3/8-12
153126	12	R1/2"	1	QSTL-1/2-12

Tech Sheet 70399

QS, STANDARD SERIES PUSH-IN FITTINGS

 **Ambient Temperature:**
-10°C to +80°C

 **Temperature Dependent Operating Pressure:**
- 0.95 to 6 bar at 80°C
- 0.95 to 14 bar at 20°C

- Simple and reliable connection and release
- Wide range of variants: large selection for maximum flexibility in standard applications

- PBT housing, POM release ring, NBR tube seal
- Operating media: compressed air, vacuum, (water as per manufacturer's declaration)

Male Stud Ys



Male Thread, BSPT

0009	OD mm	Thread	Quantity	Manufacturer's Code
153138	4	R1/8"	10	QSY-1/8-4
190675	4	R1/4"	10	QSY-1/4-4
153139	6	R1/8"	10	QSY-1/8-6
153140	6	R1/4"	10	QSY-1/4-6
153141	8	R1/8"	10	QSY-1/8-8
153142	8	R1/4"	10	QSY-1/4-8
153143	8	R3/8"	10	QSY-3/8-8
153145	10	R3/8"	10	QSY-3/8-10
153144	10	R1/4"	10	QSY-1/4-10
153146	12	R3/8"	10	QSY-3/8-12
153147	12	R1/2"	1	QSY-1/2-12

Tech Sheet 70404



Male Thread, Metric

0009	OD mm	Thread	Quantity	Manufacturer's Code
190673	4	M5	10	QSY-M5-4
190674	6	M5	10	QSY-M5-6

Tech Sheet 70405

Male Stud 90° Ys



Male Thread, BSPT

0009	OD mm	Thread	Quantity	Manufacturer's Code
153172	4	R1/8"	1	QSYL-1/8-4
153173	6	R1/8"	1	QSYL-1/8-6
153174	6	R1/4"	1	QSYL-1/4-6
153175	8	R1/8"	1	QSYL-1/8-8
153176	8	R1/4"	1	QSYL-1/4-8
153177	8	R3/8"	1	QSYL-3/8-8
153178	10	R1/4"	1	QSYL-1/4-10
153179	10	R3/8"	1	QSYL-3/8-10
153180	12	R3/8"	1	QSYL-3/8-12
153181	12	R1/2"	1	QSYL-1/2-12

Tech Sheet 70401

Single Banjos



Male Thread, BSPT (Hex Body)

0009	OD mm	Thread	Quantity	Manufacturer's Code
153086	4	R1/8"	10	QSLV-1/8-4
153087	6	R1/8"	10	QSLV-1/8-6
153088	6	R1/4"	10	QSLV-1/4-6
153089	8	R1/8"	10	QSLV-1/8-8
153090	8	R1/4"	10	QSLV-1/4-8
153091	8	R3/8"	10	QSLV-3/8-8
153092	10	R1/4"	10	QSLV-1/4-10
153093	10	R3/8"	10	QSLV-3/8-10
153094	12	R3/8"	10	QSLV-3/8-12
153095	12	R1/2"	1	QSLV-1/2-12

Tech Sheet 70392



Male Thread, BSPP (Hex Body)

0009	OD mm	Thread	Quantity	Manufacturer's Code
186137	4	G1/8"	10	QSLV-G1/8-4
190666	6	M5	10	QSLV-M5-6
186138	6	G1/8"	10	QSLV-G1/8-6
186139	6	G1/4"	10	QSLV-G1/4-6
186140	8	G1/8"	10	QSLV-G1/8-8
186141	8	G1/4"	10	QSLV-G1/4-8
186142	8	G3/8"	10	QSLV-G3/8-8
186143	10	G1/4"	10	QSLV-G1/4-10
186144	10	G3/8"	10	QSLV-G3/8-10
186145	12	G3/8"	10	QSLV-G3/8-12
186146	12	G1/2"	1	QSLV-G1/2-12

Tech Sheet 70390

Tube x Tube Connectors



Equal Straights

0009	OD mm	Quantity	Manufacturers Code
153031	4	10	QS-4
153032	6	10	QS-6
153033	8	10	QS-8
153034	10	10	QS-10
153035	12	10	QS-12

Tech Sheet 70417



Unequal Straights

0009	OD mm	OD mm	Quantity	Manufacturers Code
153037	6	4	10	QS-6-4
130606	8	4	10	QS-8-4
153038	8	6	10	QS-8-6
130607	10	6	10	QS-10-6
153039	10	8	10	QS-10-8
130608	12	8	10	QS-12-8
153040	12	10	10	QS-12-10

Tech Sheet 70418



Equal Bulkheads with Fixed Collar

0009	OD mm	Quantity	Manufacturers Code
130642	8	10	QSS-8-F
130643	10	10	QSS-10-F
130644	12	10	QSS-12-F

Tech Sheet 70421



Equal Bulkheads

0009	OD mm	Quantity	Manufacturers Code
153157	4	10	QSS-4
153158	6	10	QSS-6
153159	8	10	QSS-8
153160	10	10	QSS-10
153161	12	10	QSS-12

Tech Sheet 70422

QS, STANDARD SERIES PUSH-IN FITTINGS

FESTO

 **Ambient Temperature:**
-10°C to +80°C

 **Temperature Dependant Operating Pressure:**
- 0.95 to 6 bar at 80°C
- 0.95 to 14 bar at 20°C

- Simple and reliable connection and release
- Wide range of variants: large selection for maximum flexibility in standard applications

- PBT housing, POM release ring, NBR tube seal
- Operating media: compressed air, vacuum, (water as per manufacturer's declaration)

Tube x Tube Connectors

Equal Elbows



0009	OD mm	Quantity	Manufacturers Code
153070	4	10	QSL-4
153071	6	10	QSL-6
153072	8	10	QSL-8
153073	10	10	QSL-10
153074	12	10	QSL-12

Tech Sheet 70424

Equal Tees



0009	OD mm	Quantity	Manufacturers Code
153128	4	10	QST-4
153129	6	10	QST-6
153130	8	10	QST-8
153131	10	10	QST-10
153132	12	10	QST-12

Tech Sheet 70426

Unequal Tees



0009	OD mm	OD mm	Quantity	Manufacturers Code
153134	6	4	10	QST-6-4
130613	8	4	10	QST-8-4
153135	8	6	10	QST-8-6
130614	10	6	10	QST-10-6
153136	10	8	10	QST-10-8
130615	12	8	10	QST-12-8
153137	12	10	10	QST-12-10
130616	16	12	1	QST-16-12

Tech Sheet 70427

Equal Ys



0009	OD mm	Quantity	Code
153148	4	10	QSY-4
153149	6	10	QSY-6
153150	8	10	QSY-8
153151	10	10	QSY-10
153152	12	10	QSY-12

Tech Sheet 70429

Unequal Ys



0009	OD mm	OD mm	Quantity	Manufacturers Code
153153	6	4	10	QSY-6-4
130610	8	4	10	QSY-8-4
153154	8	6	10	QSY-8-6
130611	10	6	10	QSY-10-6
153155	10	8	10	QSY-10-8
130612	12	8	10	QSY-12-8
153156	12	10	10	QSY-12-10
190708	16	12	1	QSY-16-12

Tech Sheet 70430

Tube x Stem Connectors



Straights, Tube x Stem

0009	OD mm	Stem OD mm	Quantity	Code
153041	6	4	10	QS-6H-4
130622	8	4	10	QS-8H-4
153042	8	6	10	QS-8H-6
130623	10	6	10	QS-10H-6
153043	10	8	10	QS-10H-8
132981	12	6	10	QS-12H-6
130624	12	8	10	QS-12H-8
153044	12	10	10	QS-12H-10
130698	12	10	20	QS-12H-10-20

Tech Sheet 70431

Elbows, Tube x Stem



0009	OD mm	Stem OD mm	Quantity	Manufacturers Code
153056	4	4	10	QSL-4H
153057	6	6	10	QSL-6H
153058	8	8	10	QSL-8H
153059	10	10	10	QSL-10H
153060	12	12	10	QSL-12H

Tech Sheet 70432

Reducing Elbows, Tube x Stem



0009	OD mm	Stem OD mm	Quantity	Code
153061	6	4	10	QSL-6H-4
153062	8	6	10	QSL-8H-6
153063	10	8	10	QSL-10H-8

Tech Sheet 70433

Tube x Tube Plugs



Tube

0009	OD mm	Quantity	Code
153262	4	10	QSC-4
153263	6	10	QSC-6
153264	8	10	QSC-8
153265	10	10	QSC-10
153266	12	10	QSC-12

Tech Sheet 70440

Tube x Stem Extended Connectors



Elbows, Tube x Stem

0009	OD mm	Stem OD mm	Quantity	Code
153065	4	4	10	QSL-4HL
153066	6	6	10	QSL-6HL
153067	8	8	10	QSL-8HL
153068	10	10	10	QSL-10HL
153069	12	12	10	QSL-12HL

Tech Sheet 70434

Tube x Stem Plugs



Tube x Stem

0009	OD mm	Stem OD mm	Quantity	Manufacturers Code
153267	4	4	10	QSC-4H
153268	6	6	10	QSC-6H
153269	8	8	10	QSC-8H
153270	10	10	10	QSC-10H
153271	12	12	10	QSC-12H

Tech Sheet 70441

QS, MINIATURE SERIES PUSH-IN FITTINGS

FESTO

 **Ambient Temperature:**
-10°C to +80°C

 **Temperature Dependent Operating Pressure:**
- 0.95 to 6 bar at 80°C
- 0.95 to 14 bar at 20°C

- Simple and reliable connection and release
- Compact for maximum component density in confined installation space

- PBT housing, POM release ring, NBR tube seal
- Operating media: compressed air, vacuum

Male Studs



Male Thread, BSPP

0009	OD mm	Thread	Quantity	Code
186266	4	G1/8"	10	QSM-G1/8-4-I
186267	6	G1/8"	10	QSM-G1/8-6-I
Tech Sheet 70481				



Male Thread, Metric & BSPT

0009	OD mm	Thread	Quantity	Code
153314	4	M3	10	QSM-M3-4-I
153315	4	M5	10	QSM-M5-4-I
153319	4	M7	10	QSM-M7-4-I
153316	4	R1/8"	10	QSM-1/8-4-I
153321	6	M7	10	QSM-M7-6-I
153317	6	M5	10	QSM-M5-6-I
153318	6	R1/8"	10	QSM-1/8-6-I
Tech Sheet 70479				



Male Thread, BSPP (Hex Body)

0009	OD mm	Thread	Quantity	Code
186264	4	R1/8"	10	QSM-G1/8-4
186265	6	R1/8"	10	QSM-G1/8-6
Tech Sheet 70480				



Male Thread, Metric & BSPT (Hex Body)

0009	OD mm	Thread	Quantity	Code
153303	4	M3	10	QSM-M3-4
153304	4	M5	10	QSM-M5-4
153305	4	R1/8"	10	QSM-1/8-4
153306	6	M5	10	QSM-M5-6
132600	6	M6	10	QSM-M6-6
153307	6	R1/8"	10	QSM-1/8-6
Tech Sheet 70478				

Male Stud 90° Elbows



Male Thread, BSPP

0009	OD mm	Thread	Quantity	Code
186268	4	G1/8"	10	QSML-G1/8-4
186269	6	G1/8"	10	QSML-G1/8-6
Tech Sheet 70484				



Male Thread, Metric & BSPT

0009	OD mm	Thread	Quantity	Code
153332	4	M3	10	QSML-M3-4
153333	4	M5	10	QSML-M5-4
186352	4	M7	10	QSML-M7-4
153334	4	R1/8"	10	QSML-1/8-4
153335	6	M5	10	QSML-M5-6
186353	6	M7	10	QSML-M7-6
153336	6	R1/8"	10	QSML-1/8-6
Tech Sheet 70483				

FESTO

You might also need
SPAN Series Pressure Sensors
see page 428



QS, MINIATURE SERIES PUSH-IN FITTINGS

FESTO

 **Ambient Temperature:**
-10°C to +80°C

 **Temperature Dependant Operating Pressure:**
- 0.95 to 6 bar at 80°C
- 0.95 to 14 bar at 20°C

- Simple and reliable connection and release
- Compact for maximum component density in confined installation space

- PBT housing, POM release ring, NBR tube seal
- Operating media: compressed air, vacuum

Tube x Tube Connectors



Equal Straights

0009	OD mm	Quantity	Code
153324	4	10	QSM-4
153325	6	10	QSM-6

Tech Sheet 70491



Unequal Straights

0009	OD mm	OD mm	Quantity	Code
153326	4	3	10	QSM-4-3
153327	6	4	10	QSM-6-4

Tech Sheet 70492



Equal Bulkheads

0009	OD mm	Quantity	Code
153376	4	10	QSMS-4
153377	6	10	QSMS-6

Tech Sheet 70498



Equal Elbows

0009	OD mm	Quantity	Code
153344	4	10	QSML-4
153345	6	10	QSML-6

Tech Sheet 70493



Equal Tees

0009	OD mm	Quantity	Code
153366	4	10	QSMT-4
153367	6	10	QSMT-6

Tech Sheet 70494



Unequal Tees

0009	OD mm	OD mm	Quantity	Code
153368	4	3	10	QSMT-4-3
153369	6	4	10	QSMT-6-4

Tech Sheet 70495



Equal Ys

0009	OD mm	Quantity	Code
153371	4	10	QSMY-4
153372	6	10	QSMY-6

Tech Sheet 70496



Unequal Ys

0009	OD mm	OD mm	Quantity	Code
153373	4	3	10	QSMY-4-3
153374	6	4	10	QSMY-6-4

Tech Sheet 70497

Tube x Stem Connectors



Unequal Straights, Tube x Stem

0009	ODmm	Stem OD mm	Quantity	Code
153328	4	3	10	QSM-4H-3
153329	6	4	10	QSM-6H-4

Tech Sheet 70499



Equal Elbows, Tube x Stem

0009	OD mm	Stem OD mm	Quantity	Code
153347	4	4	10	QSML-4H
153348	6	6	10	QSML-6H

Tech Sheet 70500



Unequal Elbows, Tube x Stem

0009	OD mm	Stem OD mm	Quantity	Code
153349	4	3	10	QSML-4H-3
153350	6	4	10	QSML-6H-4

Tech Sheet 70501

FLOW REGULATORS & FUNCTION FITTINGS

For the full range and more information, please contact one of our sales team.

FLOW REGULATORS



Features

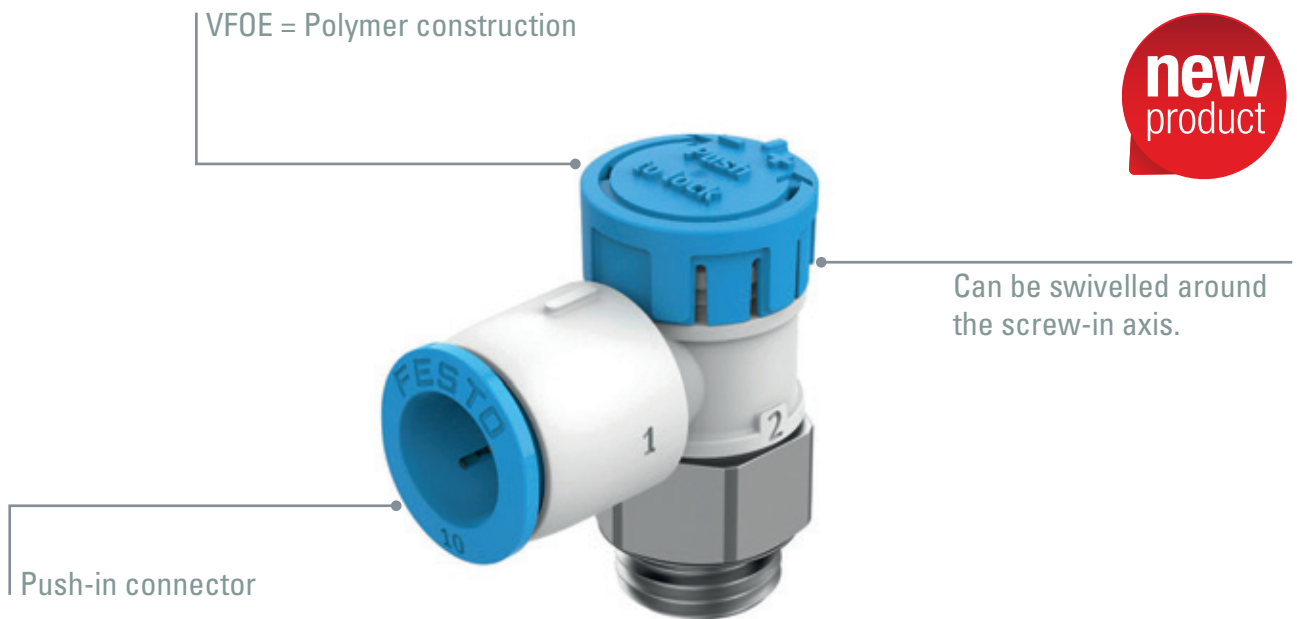

Product Description

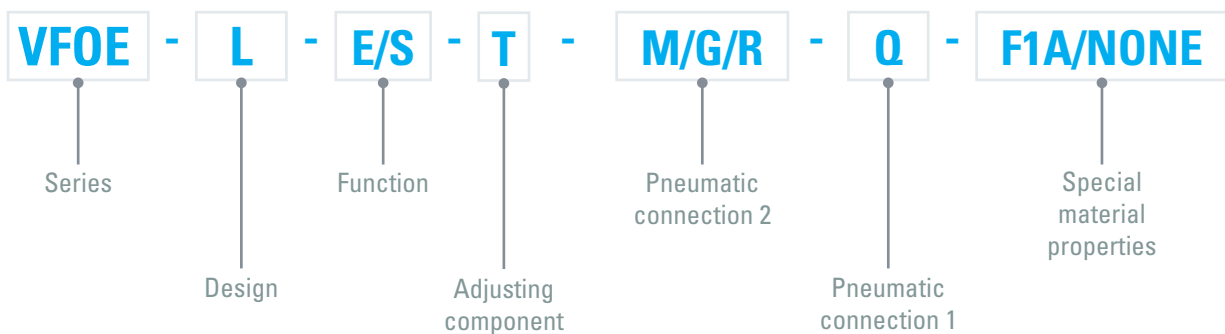



One-way Flow Control Valves, Elbow Outlet

Ambient Temperature:
-10°C to +60°C

- Sturdy metal design
- Can be swivelled around the screw-in axis after mounting
- Push-in connector

Working Pressure:
0.2 to 10 bar

- Polymer design
- Can be rotated 360° around the screw-in axis after mounting/not permitted for continuous rotation
- Push-in connector

- Polymer design



Exhaust Control, Rotary Knob Detented, Metric & BSPP

0009	OD mm	Thread	Manufacturer's Code
8068723	4	M5	VFOE-LE-T-M5-Q4
8068724	6	M5	VFOE-LE-T-M5-Q6
8068725	4	1/8"	VFOE-LE-T-G18-Q4
8068726	6	1/8"	VFOE-LE-T-G18-Q6
8068727	8	1/8"	VFOE-LE-T-G18-Q8
8068728	6	1/4"	VFOE-LE-T-G14-Q6
8068729	8	1/4"	VFOE-LE-T-G14-Q8
8068732	10	3/8"	VFOE-LE-T-G38-Q10

Tech Sheet 71679

Exhaust Control, Rotary Knob Detented, BSPT

0009	OD mm	Thread	Manufacturer's Code
8068734	4	1/8"	VFOE-LE-T-R18-Q4
8068735	6	1/8"	VFOE-LE-T-R18-Q6
8068736	8	1/8"	VFOE-LE-T-R18-Q8

Tech Sheet 71679

- Polymer design



Supply Air One-way Detented Flow Control Function, BSPP

0009	OD mm	Thread	Manufacturer's Code
8068747	4	1/8"	VFOE-LS-T-G18-Q4
8068748	6	1/8"	VFOE-LS-T-G18-Q6
8068749	8	1/8"	VFOE-LS-T-G18-Q8

Supply Air One-way Detented, Flow Control Function, BSPT

0009	OD mm	Thread	Manufacturer's Code
8068750	4	1/8"	VFOE-LS-T-R18-Q4
8068751	6	1/8"	VFOE-LS-T-R18-Q6
8068752	8	1/8"	VFOE-LS-T-R18-Q8

- Sturdy metal design



Supply Control, Slotted Head Screw, Male Thread, Metric & BSPP x Push-in

0009	OD mm	Thread	Manufacturer's Code
193153	3	M5	GRLZ-M5-QS-3-D
193156	3	G1/8"	GRLZ-1/8-QS-3-D
193154	4	M5	GRLZ-M5-QS-4-D
193157	4	G1/8"	GRLZ-1/8-QS-4-D
193155	6	M5	GRLZ-M5-QS-6-D
193158	6	G1/8"	GRLZ-1/8-QS-6-D
193159	8	G1/8"	GRLZ-1/8-QS-8-D

Tech Sheet 71232

- Sturdy metal design



Exhaust Control, Slotted Head Screw, Male Thread, Metric & BSPP x Push-in

0009	OD mm	Thread	Manufacturer's Code
193137	3	M5	GRLA-M5-QS-3-D
193142	3	G1/8"	GRLA-1/8-QS-3-D
193138	4	M5	GRLA-M5-QS-4-D
193143	4	G1/8"	GRLA-1/8-QS-4-D
193139	6	M5	GRLA-M5-QS-6-D
193144-FESTO	6	G1/8"	GRLA-1/8-QS-6-D
193146	6	G1/4"	GRLA-1/4-QS-6-D
193149	6	G3/8"	GRLA-3/8-QS-6-D
193145	8	G1/8"	GRLA-1/8-QS-8-D
193147	8	G1/4"	GRLA-1/4-QS-8-D
193150	8	G3/8"	GRLA-3/8-QS-8-D
193148	10	G1/4"	GRLA-1/4-QS-10-D
193151	10	G3/8"	GRLA-3/8-QS-10-D
193152	12	G1/2"	GRLA-1/2-QS-12-D

Tech Sheet 71233

- Sturdy metal design



Exhaust Control, Knurled Screw, Male Thread, Metric & BSPP x Push-in

0009	OD mm	Thread	Manufacturer's Code
197576	3	M5	GRLA-M5-QS-3-RS-D
197579	3	G1/8"	GRLA-1/8-QS-3-RS-D
197577	4	M5	GRLA-M5-QS-4-RS-D
197580	4	G1/8"	GRLA-1/8-QS-4-RS-D
197578	6	M5	GRLA-M5-QS-6-RS-D
197581	6	G1/8"	GRLA-1/8-QS-6-RS-D
534338	6	G1/4"	GRLA-1/4-QS-6-RS-D
534341	6	G3/8"	GRLA-3/8-QS-6-RS-D
534337	8	G1/8"	GRLA-1/8-QS-8-RS-D
534339	8	G1/4"	GRLA-1/4-QS-8-RS-D
534342	8	G3/8"	GRLA-3/8-QS-8-RS-D
534340	10	G1/4"	GRLA-1/4-QS-10-RS-D
534343	10	G3/8"	GRLA-3/8-QS-10-RS-D
534344	12	G1/2"	GRLA-1/2-QS-12-RS-D

Tech Sheet 71237

- Sturdy metal design



Medium Flow, Exhaust Control, Slotted Head Screw, Male Thread, Metric & BSPP x Push-in

0009	OD mm	Thread	Manufacturer's Code
537075	6	G1/8"	GRLA-1/8-QS-6-MF-D
537076	8	G1/8"	GRLA-1/8-QS-8-MF-D

Tech Sheet 71236

FUNCTION FITTINGS

Piloted Non-return Valves

- Controlled, piloted non-return function
- Manual exhausting
- Rotatable when installed
- Push-in fitting



Working Pressure:

0.5 to 10 bar

Pilot Pressure:

2 to 10 bar (M5, 1/8, 1/4)

1 to 10 bar (3/8, 1/2)



Ambient Temperature:

-10°C to +60°C



Male Thread, BSPP

0009	Thread	Manufacturer's Code
530029	M5	HGL-M5-B
530030	G1/8"	HGL-1/8-B
530031	G1/4"	HGL-1/4-B
530032	G3/8"	HGL-3/8-B
530033	G1/2"	HGL-1/2-B

Tech Sheet 71243



Male Thread BSPP x Push-in

0009	OD mm	Thread	Manufacturer's Code
530038	4	M5	HGL-M5-QS-4
530039	4	G1/8"	HGL-1/8-QS-4
530040	6	G1/8"	HGL-1/8-QS-6
530041	8	G1/4"	HGL-1/4-QS-8
530043	8	G3/8"	HGL-3/8-QS-8
530042	10	G1/4"	HGL-1/4-QS-10
530044	10	G3/8"	HGL-3/8-QS-10
530045	12	G1/2"	HGL-1/2-QS-12

Tech Sheet 71242

FESTO



Differential Pressure Regulator

- Constant differential pressure between input and output
- Cuts energy usage on cylinder return stroke approx 20%
- Connecting thread M5, R1/8, R1/4, R3/8, R1/2
- Push-in connector for tubing OD 4, 6, 8, 10, 12mm
- Rotatable 360 degrees

new product



Energy Saving Regulator LRL, LLLL

0010	Thread	Outlet Port	Type
153510	M5	Top	LRL-M5-QS-4
153512	M5	Top	LRL-M5-QS-6
153511	1/8"	Top	LRL-1/8-QS-4
153513	1/8"	Top	LRL-1/8-QS-6
153515	1/8"	Top	LRL-1/8-QS-8
153514	1/4"	Top	LRL-1/4-QS-6
153516	1/4"	Top	LRL-1/4-QS-8
153518	1/4"	Top	LRL-1/4-QS-10
153517	3/8"	Top	LRL-3/8-QS-8
153519	3/8"	Top	LRL-3/8-QS-10
153520	3/8"	Top	LRL-3/8-QS-12
153521	1/2"	Top	LRL-1/2-QS-12
153498	M5	Side	LRL-M5-QS-4
153500	M5	Side	LRL-M5-QS-6
153499	1/8"	Side	LRL-1/8-QS-4
153501	1/8"	Side	LRL-1/8-QS-6
153503	1/8"	Side	LRL-1/8-QS-8
153502	1/4"	Side	LRL-1/4-QS-6
153504	1/4"	Side	LRL-1/4-QS-8
153506	1/4"	Side	LRL-1/4-QS-10
153505	3/8"	Side	LRL-3/8-QS-8
153507	3/8"	Side	LRL-3/8-QS-10
153508	3/8"	Side	LRL-3/8-QS-12
153509	1/2"	Side	LRL-1/2-QS-12

More variants available online

FESTO

You might also need
SFAB Series Flow Sensors
 see page 427



55000 SERIES, 20 BAR RATED



Working Temperature:
-20°C to +80°C

Maximum Working Pressure:
20 bar

BSPT in conformity with ISO 7.1, BS 21, DIN 2999.

BSPP in conformity with ISO 228 Class A.

Metric in conformity with ISO R/262.

Fittings with "Short" tapered thread allow assembly with tapered as well as parallel threads (BSPT, NPT and BSPP) and have reduced overall height.2

Straight Male Adaptors

This is a Taper Thread designed so that it's suitable for BSPT, BSPP, NPTF and Metric.



Universal Short Thread Type

1020	OD mm	Thread
5500000001	4	1/8"
5500000013	4	1/4"
5500000002	5	1/8"
5500000003	5	1/4"
5500000004	6	1/8"
5500000005	6	1/4"
5500000014	6	3/8"
5500000015	6	1/2"
5500000006	8	1/8"
5500000007	8	1/4"
5500000008	8	3/8"
5500000016	8	1/2"
5500000009	10	1/4"
5500000010	10	3/8"
5500000017	10	1/2"
5500000011	12	1/4"
5500000012	12	3/8"
5500000018	12	1/2"
5500000019	14	3/8"
5500000020	14	1/2"

Tech Sheet 10709



(Round Body) BSPT

1020	OD mm	Thread
5501000001	4	1/8"
5501000002	6	1/8"
5501000003	6	1/4"
5501000004	8	1/8"
5501000005	8	1/4"

Tech Sheet 10709



(Hex Body) Metric & BSPP

1020	OD mm	Thread
5002000N01	4	M5
5002000N02	4	1/8"
5002000N22	4	1/4"
5002000N18	5	M5
5002000N19	5	1/8"
5002000N20	6	M5
5002000N12	6	M12 x 1
5002000N13	6	M12 x 1.25
5002000N14	6	M12 x 1.5
5002000N03	6	1/8"
5002000N04	6	1/4"
5002000N27	6	3/8"
5002000N28	6	1/2"
5002000N17	8	M12 x 1.5
5002000N05	8	1/8"
5002000N06	8	1/4"
5002000N07	8	3/8"
5002000N29	8	1/2"
5002000N08	10	1/4"
5002000N09	10	3/8"
5002000N31	10	1/2"
5002000N32	12	1/4"
5002000N11	12	3/8"
5002000N23	12	1/2"
5002000N24	14	3/8"
5002000N25	14	1/2"

Tech Sheet 10709

Straight Female Adaptors



(Hex Body) Metric & BSPT

1020	OD mm	Thread
5003000N08	4	M5
5003000N01	4	1/8"
5003000N09	4	1/4"
5003000N06	5	1/8"
5003000N02	6	1/8"
5003000N03	6	1/4"
5003000N04	8	1/8"
5003000N05	8	1/4"
5003000N10	8	3/8"
5003000N11	10	1/4"
5003000N12	10	3/8"
5003000N13	10	1/2"
5003000N14	12	3/8"
5003000N15	12	1/2"

Tech Sheet 10709

Bulkhead Connectors



Tube x Tube

1020	OD mm
5005000N01	4
5005000N06	5
5005000N02	6
5005000N03	8
5005000N04	10
5005000N05	12

Tech Sheet 10709

55000 SERIES METAL BODY PUSH-IN FITTINGS



Working Temperature:
-20°C to +80°C



Maximum Working Pressure:
20 bar

Parallel gas in conformity with ISO 228 Class A
Metric in conformity with ISO R/262

Straight Connectors



Equal Straight Connectors

1020	OD mm
55040-4	4
55040-5	5
55040-6	6
55040-8	8
55040-10	10
55040-12	12
55040-14	14

Tech Sheet 10709

Unequal Straight Connectors

1020	OD mm	OD mm
55040-6-4	6	4
55040-8-6	8	6
55040-10-8	10	8
55040-12-10	12	10
55040-10-6	10	6

Tech Sheet 10709

Male Swivel Elbows

This is a taper thread designed so that its suitable for BSPT, BSPP, NPTF and metric.



Universal Short Thread Type

1020	OD mm	Thread
55111-4-1/8	4	1/8"
55111-4-1/4	4	1/4"
55111-5-1/8	5	1/8"
55111-6-1/2	6	1/2"
55111-6-1/8	6	1/8"
55111-6-1/4	6	1/4"
55111-6-3/8	6	3/8"
55111-8-1/8	8	1/8"
55111-8-1/4	8	1/4"
55111-8-3/8	8	3/8"
55111-8-1/2	8	1/2"
55111-10-1/4	10	1/4"
55111-10-3/8	10	3/8"
55111-10-1/2	10	1/2"
55111-12-1/4	12	1/4"
55111-12-3/8	12	3/8"
55111-12-1/2	12	1/2"
55111-14-3/8	14	3/8"
55111-14-1/2	14	1/2"

Tech Sheet 10709



Metric & BSPP

1020	OD mm	Thread
55116-4-M3X0.5	4	M3 x 0.5
55116-4-M5	4	M5
55116-4-M7X1	4	M7 x 1
55116-4-1/8	4	1/8"
55116-4-1/4	4	1/4"
55116-5-M5	5	M5
55116-5-1/8	5	1/8"
55116-6-M5	6	M5
55116-6-1/8	6	1/8"
55116-6-1/4	6	1/4"
55116-6-3/8	6	3/8"
55116-6-1/2	6	1/2"
55116-8-1/8	8	1/8"
55116-8-1/4	8	1/4"
55116-8-3/8	8	3/8"
55116-8-1/2	8	1/2"
55116-10-1/4	10	1/4"
55116-10-3/8	10	3/8"
55116-10-1/2	10	1/2"
55116-12-1/4	12	1/4"
55116-12-3/8	12	3/8"
55116-12-1/2	12	1/2"
55116-14-3/8	14	3/8"
55116-14-1/2	14	1/2"

Tech Sheet 10709

Elbow Connectors



Equal Elbow Connectors

1020	OD mm
55130-4	4
55130-5	5
55130-6	6
55130-8	8
55130-10	10
55130-12	12
55130-14	14

Tech Sheet 10709



Equal Stem Elbows

1020	OD mm
55140-4	4
55140-6	6
55140-8	8
55140-10	10
55140-12	12

Tech Sheet 10709

Reducing Stem Elbows

1020	OD mm	Stem OD mm
55140-4-6	4	6
55140-6-4	6	4
55140-8-10	8	10
55140-10-12	10	12

Tech Sheet 10709



For **PRO3**
see page **420**

55000 SERIES, 20 BAR RATED



Working Temperature:
-20°C to +80°C

Maximum Working Pressure: 20 bar
Vacuum: -0.99 bar

Parallel gas in conformity with ISO 228 Class A
Metric in conformity with ISO R/262

Fittings with "Universal Short" thread are suitable for both taper as well as parallel threads like NPT, NPTF, BSPP and BSPT

Tee Connectors



Equal Tees

1020	OD mm
55230-4	4
55230-5	5
55230-6	6
55230-8	8
55230-10	10
55230-12	12
55230-14	14

Tech Sheet 10709



Equal Stem Tees

1020	OD mm
55240-4	4
55240-6	6
55240-8	8
55240-10	10
55240-12	12

Tech Sheet 10709



Reducing Stem Tees

1020	OD mm	Stem OD mm
55240-4-6	4	6
55240-6-4	6	4
55240-8-10	8	10
55240-10-12	10	12

Tech Sheet 10709

Y Connectors



Equal Y Connectors

1020	OD mm
55310-4	4
55310-6	6
55310-8	8
55310-10	10
55310-12	12

Tech Sheet 10709

In-line Manifolds



Reducing, Tube x Tube

1020	OD mm	OD mm
55350-6-4	6	4
55350-8-4	8	4
55350-8-6	8	6
55350-10-6	10	6
55350-10-8	10	8

Tech Sheet 10709

Double Y Connectors



Tube x Tube, Reducing

1020	OD mm	OD mm
55330-4-4	4	4
55330-4-6	6	4
55330-6-6	6	6
55330-6-8	8	6

Tech Sheet 10709



Tube x Male Thread, Universal, BSPT, BSPP & NPT

1020	OD mm	Thread
55340-4-1/8	4	1/8"
55340-4-1/4	4	1/4"
55340-6-1/8	6	1/8"
55340-6-1/4	6	1/4"

Tech Sheet 10709



Tube x Male Thread, BSPP

1020	OD mm	Thread
55345-4-1/8	4	1/8"
55345-4-1/4	4	1/4"
55345-6-1/8	6	1/8"
55345-6-1/4	6	1/4"

Tech Sheet 10709

Banjos



Single Body, Metric & BSPP

1020	OD mm	Thread
55500-4-M5	4	M5
55500-4-M6	4	M6
55500-4-1/8	4	1/8"
55500-5-M5	5	M5
55500-5-M6	5	M6
55500-5-1/8	5	1/8"
55500-5-1/4	5	1/4"
55500-6-M5	6	M5
55500-6-M6	6	M6
55500-6-1/8	6	1/8"
55500-6-1/4	6	1/4"
55500-8-1/8	8	1/8"
55500-8-1/4	8	1/4"
55500-8-3/8	8	3/8"
55500-10-3/8	10	3/8"
55500-12-3/8	12	3/8"
55500-12-1/2	12	1/2"

Tech Sheet 10709



Double Banjo Body, Metric & BSPP

1020	OD mm	Thread
55510-4-M5	4	M5
55510-5-1/8	5	1/8"
55510-5-1/4	5	1/4"
55510-6-1/8	6	1/8"
55510-6-1/4	6	1/4"
55510-8-1/8	8	1/8"
55510-8-1/4	8	1/4"

Tech Sheet 10709

55000 SERIES, 20 BAR RATED



Banjo Bolts



Single, Metric & BSPP

1020	Thread
55410-M5	M5
55410-M6	M6
55410-1/8	1/8"
55410-1/4	1/4"
55410-3/8	3/8"
55410-1/2	1/2"
55410-M12X1.5	M12 x 1.5

Tech Sheet 10709



Double, BSPP

1020	Thread
55420-1/8	1/8"
55420-1/4	1/4"
55420-3/8	3/8"
55420-1/2	1/2"

Tech Sheet 10709



Triple, BSPP

1020	Thread
55430-1/8	1/8"
55430-1/4	1/4"
55430-3/8	3/8"
55430-1/2	1/2"

Tech Sheet 10709

56000 SERIES - MINIATURE PUSH-IN FITTINGS



Working Temperature:
-20 to 80

Maximum Working Pressure:
20 bar (290 psi)

Vacuum: -0.99 bar

Male Studs



Male Thread, Metric

1020	OD mm	Thread
MP1-2-M3	2	M3
MP1-2-M5	2	M5
MP1-3-M3	3	M3
MP1-3-M5	3	M5

Tech Sheet 984

Swivel Male Stud Elbow



Male Thread, Metric

1020	OD mm	Thread
MP7-2-M3	2	M3
MP7-2-M5	2	M5
MP7-3-M3	3	M3
MP7-3-M5	3	M5

Tech Sheet 984

Swivel Tee Male Centre Leg



Male Thread, Metric

1020	OD mm	Thread
MP12-3-M5	3	M5

Tech Sheet 984



For **Quick Couplings for Plastic Injection Moulding**
see page 391



METRIC PUSH-IN FITTINGS, TECHNOPOLYMER

Straight Connector



Tube x Tube

9151	Tube OD mm
2019001	4
2019002	5
2019003	6
2019004	8
2019005	10
2019006	12

Equal Elbow



Tube x Tube

9151	Tube OD mm
2L21001	4
2021002	5
2L21003	6
2L21004	8
2021005	10
2021006	12

Equal Tee



Tube x Tube

9151	Tube OD mm
2L22001	4
2022002	5
2L22003	6
2L22004	8
2022005	10
2022006	12

Male Stud Swivel Elbow



BSP Parallel x Tube

9151	Thread BSPP	Tube OD mm
2L34001	M5	4
2L34002	G1/8"	4
2L34003	G1/4"	4
2L34006	M5	6
2L34007	G1/8"	6
2L34008	G1/4"	6
2L34009	G1/8"	8
2L34010	G1/4"	8
2L34011	G3/8"	8
2L34013	G1/4"	10
2L34014	G3/8"	10
2L34016	G3/8"	12
2L34017	G1/2"	12

Female Stud Swivel Elbow



BSP Parallel x Tube

9151	Thread BSPP	Tube OD mm
2L34F01	M5	4
2L34F06	M5	6
2L34F05	G1/8"	4
2L34F07	G1/8"	6
2L34F08	G1/4"	6
2L34F09	G1/8"	8
2L34F10	G1/4"	8

Plug



Stem

9151	Tube OD mm
2L10001	4
2010002	5
2L10003	6
2L10004	8
2L10005	10
2L10006	12
2010007	14

Male Stud Swivel Tee



BSP Parallel x Tube

9151	Thread BSPP	Tube OD mm
2L35001	M5	4
2L35002	G1/8"	4
2L35003	G1/4"	4
2L35006	M5	6
2L35007	G1/8"	6
2L35008	G1/4"	6
2L35009	G1/8"	8
2L35010	G1/4"	8
2L35011	G3/8"	8
2L35013	G1/4"	10
2L35014	G3/8"	10
2L35016	G3/8"	12
2L35017	G1/2"	12

Equal Y



Tube x Tube

9151	Tube OD mm
2023001	4
2023002	5
2023003	6
2023004	8
2L23005	10
2L23006	12

Male Stud Y



BSP Parallel x Tube

9151	Thread BSPP	Tube OD mm
2L23402	G1/8"	4
2L23403	G1/4"	4
2L23406	G1/8"	6
2L23407	G1/4"	6
2L23409	G1/8"	8
2L23410	G1/4"	8
2L23412	G3/8"	8

METRIC PUSH-IN FITTINGS, TECHNOPOLYMER

Y Stem



Stem x Tube

9151	OD mm Stem	OD mm Tube
2024001	4	4
2024003	6	6
2L24004	8	8
2L24005	10	10
2L24006	12	12

Y Elbow



BSP Parallel x Tube

9151	Thread BSPP	Tube OD mm
2L25003	G1/8"	4
2L25004	G1/8"	6
2L25005	G1/4"	6
2L25008	G1/4"	8
2L25009	G3/8"	8

Plug-in Elbow



Stem x Tube

9151	Stem OD mm	Tube OD mm
2L46001	4	4
2L46002	6	6
2L46003	8	8
2L46004	10	10

Distribution Fitting



Tube x Tube

9151	Tube OD mm A	Tube OD mm B
2L42001	4	4
2L42002	6	4
2L42004	6	6
2L42005	8	6

Distribution Fitting



BSP Parallel x Tube

9151	Thread BSPP	Tube OD mm
2L43001	M5	4
2L43002	G1/8"	4
2L43003	G1/4"	4
2L43008	G1/8"	6
2L43009	G1/4"	6

Tube Removal Tool



For use with Push-in Fittings

9150	To Suit Tube mm
2017001	4-14

Aluminium Distribution Manifold



BSP Parallel x Tube Inlet Ports

9185	BSPP Inlet Thread	Tube OD mm	Outlets
7304106	G1/8"	4	6
7304112	G1/8"	4	12
7306206	G1/4"	6	6
7306212	G1/4"	6	12
7308306	G3/8"	8	6
7308312	G3/8"	8	12



















PUSH-IN FITTINGS KITS



A convenient range of Metal Work push-in fittings in a kit. Comprising of seventeen removable compartments. These are contained in a hand carry case measuring 57mm deep x 340mm long x 265mm wide, made from tough polypropylene, with a clear view plastic hinged lid, sliding locks and carry handle. There are four pneumatic push-in fittings kits available: 4mm, 6mm 8mm and a 6/8mm combination.



















 5 x M5-4MM Male Stud	 5 x M5-4MM Stem Adaptor	 2 x 4-14MM Tool	 3 x 4MM Bulkhead	 2 x M5-4 Swivel Elbow	 2 x G1/8-4 Swivel Elbow
 5 x G1/8-4MM Male Stud	 5 x G1/8-4MM Stem Adaptor			 3 x 4/6 Enlarger	 5 x 4MM Plug
 5 x G1/4-4MM Male Stud	 5 x G1/4-4MM Stem Adaptor	 5 x 4MM Joiner	 5 x 4MM Equal Elbow	 5 x 4MM Equal Tee	
 3 x G1/8-4MM Female Stud	 3 x G1/4-4MM Female Stud				

Push-in Fittings Kit

4mm Outside Diameter













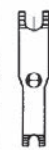



9153	Description
HANDYFIT-4	Assorted

 5 x M5-6MM Male Stud	 5 x M5-6MM Stem Adaptor	 2 x 4-14MM Tool	 3 x 6MM Bulkhead	 2 x G1/8-6 Swivel Elbow	 2 x G1/4-6 Swivel Elbow
 5 x G1/8-6MM Male Stud	 5 x G1/8-6MM Stem Adaptor			 3 x 6/4 Reducer	 5 x 6MM Plug
 5 x G1/4-6MM Male Stud	 5 x G1/4-6MM Stem Adaptor	 5 x 6MM Joiner	 5 x 6MM Equal Elbow	 5 x 6MM Equal Tee	
 3 x G1/8-6MM Female Stud	 3 x G1/4-6MM Female Stud				

Push-in Fittings Kit

6mm Outside Diameter

















9153	Description
HANDYFIT-6	Assorted

 5 x G1/8-8MM Male Stud	 5 x G1/8-8MM Stem Adaptor	 2 x 4-14MM Tool	 3 x 8MM Bulkhead	 2 x G1/8-8 Swivel Elbow	 2 x G1/4-8 Swivel Elbow
 5 x G1/4-8MM Male Stud	 5 x G1/4-8MM Stem Adaptor			 3 x 8/6 Reducer	 5 x 8MM Plug
 5 x G3/8-8MM Male Stud	 5 x G3/8-8MM Stem Adaptor	 5 x 8MM Joiner	 5 x 8MM Equal Elbow	 5 x 8MM Equal Tee	
 3 x G1/8-8MM Female Stud	 3 x G1/4-8MM Female Stud				

Push-in Fittings Kit

8mm Outside Diameter

9153	Description
HANDYFIT-8	Assorted

 5 x G1/8-8MM Male Stud	 5 x G1/8-8MM Stem Adaptor	 5 x 6MM Equal Tee	 5 x 8MM Equal Tee	 3 x 6mm Joiner	 3 x 8mm Joiner
 5 x G1/4-8MM Male Stud	 5 x G1/4-8MM Stem Adaptor			 3 x 6/4 Reducer	 3 x 8/6 Reducer
 5 x G1/8-8MM Male Stud	 5 x G1/8-8MM Stem Adaptor	 5 x 6MM Equal Elbow	 5 x 8MM Equal Elbow	 2 x 4-14MM Tool	
 5 x G1/4-8MM Male Stud	 5 x G1/4-8MM Stem Adaptor				

Push-in Fittings Kit

6mm & 8mm Outside Diameter

9153	Description
HANDYFIT-6/8	Assorted

FLOW MICRO-REGULATORS

MFR Compact 'O' Threaded Brass Ring

Technical Features

- The job of flow micro-regulators is to regulate speed in the pneumatic cylinders. The configuration of both type C (to be mounted on the cylinder inlet) and type V (to be mounted on the valve port) is such as to ensure full flow on feed and regulated flow on charge. Type B (bidirectional) can be used to regulate the flow both on feed and discharge. Flow micro-regulators are divided into 4 series:
- MRF Compact 'O': Can be adjusted using a screwdriver; the regulation pin is lubricated with a particular anti-vibration grease; it has reduced dimensions and fine adjustment in the first turns; adjustment can be prevented by assembling a disposable cap (supplied separately) that can be removed using a tool.
- MRF Compact 'N': Can be adjusted using the knob and/or screwdriver; adjustment can be prevented by tightening the ring nut; it has the same regulation curve as those in series 'O'.

Main Features

- Reduced dimensions
- Excellent regulation
- Regulation with a screwdriver and disposable anti-tampering cap (Compact 'O')
- Regulation with either a screwdriver and/or a knob, can be fixed with a ring nut (Compact 'N')
- Available in all sizes (from M5 to 1/2") with a brass or a technopolymer ring
- Can be mounted with an automatic screwdriver
- Comes with a ring that can rotate even with the MRF mounted in position

-  **Working Temperature Range:**
 -10°C to +70°C (Brass Ring)
 -10°C to +50°C (Technopolymer Ring)

-  **Maximum Working Pressure:**
 10 bar



Type C to Suit Cylinder

9148	Thread BSPT	Tube OD mm
9001001C	M5	4
9001002C	M5	5
9001007C	M5	6
9001011C	R1/8"	4
9001012C	R1/8"	5

Type V to Suit Valves

9148	Thread BSPT	Tube OD mm
9001101V	R1/8"	6
9001103V	R1/8"	8
9001102V	R1/4"	6
9001104V	R1/4"	8
9001115V	R3/8"	8

Type B Bidirectional to Suit Cylinder & Valves

9148	Thread BSPT	Tube OD mm
9001609B	R1/4"	10
9001623B	R1/4"	12
9001610B	R3/8"	10
9001624B	R3/8"	12
9001625B	R1/2"	12

MRF Compact 'O' Threaded Brass Ring, Imperial



Type C to suit Cylinder

9148	Thread BSPT	Tube OD
9001020C	R1/8"	1/8"
9001021C	R1/4"	1/4"
9001022C	R3/8"	3/8"

Type B Bidirectional to suit Cylinders & Valves

9148	Thread BSPT	Tube OD
9001620B	R1/8"	1/8"
9001621B	R1/4"	1/4"
9001622B	R3/8"	3/8"

Type V to suit Valves

9148	Thread BSPT	Tube OD
9001120V	R1/8"	1/8"
9001121V	R1/4"	1/4"
9001122V	R3/8"	3/8"

Accessories for MRF Compact 'O'



Anti-tampering Cap

9148	To Fit Thread BSPT
9090001	M5
9090002	R1/8" - R1/4"
9090003	R3/8" - R1/2"

MRF Compact 'O' Technopolymer Ring

Type C to suit Cylinder

9148	Thread BSPT	Tube OD mm
9011001C	M5	4
9011007C	M5	6
9011011C	R1/8"	4
9011003C	R1/8"	6
9011005C	R1/8"	8
9011004C	R1/4"	6
9011006C	R1/4"	8
9011008C	R1/4"	10
9011014C	R1/4"	12
9011009C	R3/8"	10
9011015C	R3/8"	12
9011016C	R1/2"	12

Type V to suit Valves

9148	Thread BSPT	Tube OD mm
9011110V	M5	4
9011105V	M5	6
9011111V	R1/8"	4
9011101V	R1/8"	6
9011103V	R1/8"	8
9011102V	R1/4"	6
9011104V	R1/4"	8
9011106V	R1/4"	10
9011123V	R1/4"	12
9011114V	R3/8"	10
9011124V	R3/8"	12
9011125V	R1/2"	12

Type B Bidirectional to suit Cylinders & Valves

9148	Thread BSPT	Tube OD mm
9011601B	M5	4
9011612B	M5	6
9011602B	R1/8"	4
9011605B	R1/8"	6
9011607B	R1/8"	8
9011606B	R1/4"	6
9011608B	R1/4"	8
9011609B	R1/4"	10
9011623B	R1/4"	12
9011610B	R3/8"	10
9011624B	R3/8"	12
9011625B	R1/2"	12



FLOW MICRO-REGULATORS

MRF Compact 'N' Brass Ring



Type C to suit Cylinder

9148	Thread BSPT	Tube OD mm
9031001C	M5	4
9031003C	M5	5
9031005C	M5	6
9031002C	R1/8"	4
9031004C	R1/8"	5
9031006C	R1/8"	6
9031008C	R1/8"	8
9031007C	R1/4"	6
9031009C	R1/4"	8
9031010C	R3/8"	8
9031011C	R1/4"	10
9031014C	R1/4"	12
9031012C	R3/8"	10
9031015C	R3/8"	12
9031016C	1/2"	12

Type V to suit Valves

9148	Thread BSPT	Tube OD mm
9031101V	M5	4
9031103V	M5	5
9031105V	M5	6
9031102V	R1/8"	4
9031104V	R1/8"	5
9031106V	R1/8"	6
9031108V	R1/8"	8
9031107V	R1/4"	6
9031109V	R1/4"	8
9031110V	R3/8"	8
9031111V	R1/4"	10
9031114V	R1/4"	12
9031112V	R3/8"	10
9031115V	R3/8"	12
9031116V	1/2"	12

Type B Bidirectional to suit Cylinders & Valves

9148	Thread BSPT	Tube OD mm
9031201B	M5	4
9031203B	M5	5
9031205B	M5	6
9031202B	R1/8"	4
9031204B	R1/8"	5
9031206B	R1/8"	6
9031208B	R1/8"	8
9031207B	R1/4"	6
9031209B	R1/4"	8
9031210B	R3/8"	8
9031211B	R1/4"	10
9031214B	R1/4"	12
9031212B	R3/8"	10
9031215B	R3/8"	12
9031216B	1/2"	12

MRF Compact 'N' Technopolymer Ring



Type C to suit Cylinder

9148	Thread BSPT	Tube OD mm
9021001C	M5	4
9021005C	M5	6
9021002C	R1/8"	4
9021006C	R1/8"	6
9021008C	R1/8"	8
9021007C	R1/4"	6
9021009C	R1/4"	8
9021011C	R1/4"	10
9021014C	R1/4"	12
9021012C	R3/8"	10
9021212C	R3/8"	10
9021015C	R3/8"	12
9021016C	R1/2"	12

Type V to suit Valves

9148	Thread BSPT	Tube OD mm
9021101V	M5	4
9021105V	M5	6
9021102V	R1/8"	4
9021106V	R1/8"	6
9021108V	R1/8"	8
9011107V	R1/4"	6
9021109V	R1/4"	8
9021111V	R1/4"	10
9021114V	R1/4"	12
9021112V	R3/8"	10
9021115V	R3/8"	12
9021116V	R1/2"	12

Type B Bidirectional to suit Cylinders & Valves

9148	Thread BSPT	Tube OD mm
9021201B	M5	4
9021205B	M5	6
9021202B	R1/8"	4
9021206B	R1/8"	6
9021208B	R1/8"	8
9021207B	R1/4"	6
9021209B	R1/4"	8
9021211B	R1/4"	10
9021214B	R1/4"	12
9021215B	R3/8"	12
9021216B	R1/2"	12

MRF Compact 'N' Threaded Brass Ring



Type C to suit Cylinder

9148	Thread BSPT	Tube OD
9031301C	R1/8"	1/8"
9031302C	R1/4"	1/4"
9031303C	R3/8"	3/8"

Type V to suit Valves

9148	Thread BSPT	Tube OD
9031401V	R1/8"	1/8"
9031402V	R1/4"	1/4"
9031403V	R3/8"	3/8"

Type B Bidirectional to suit Cylinders & Valves

9148	Thread BSPT	Tube OD
9031501B	R1/8"	1/8"
9031502B	R1/4"	1/4"
9031503B	R3/8"	3/8"

BLOCK FITTINGS

Blocking Fitting

Stop valves mounted on the cylinder inlets allow a flow of air only in the presence of a pneumatic pilot. This item is mainly used as a safety valve. When pressure drops in the pneumatic pilot, all cylinder movement is halted.

Technical Data

	Bidirectional			
	1/8"	1/4"	3/8"	1/2"
Operating Pressure bar	0.5-10			
Operating temperature °C	-10° to +60°			
Flow rate (6 bar)	320	700	1060	1700

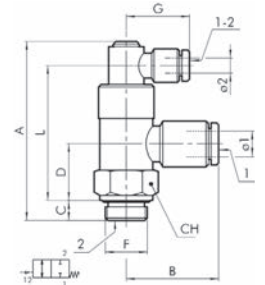
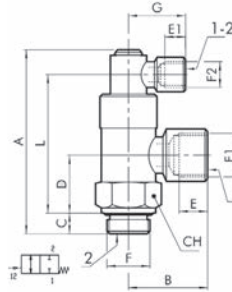

Fully Threaded

9148	F	F1	F2
W6001101001	G1/8"	G1/8"	G1/8"
W6001111011	G1/4"	G1/4"	G1/8"
W6001121021	G3/8"	G3/8"	G1/8"

Tube Fittings

9148	F	Ø1 mm	Ø2 mm
W6001101106	G1/8"	6	4
W6001111106	G1/4"	6	4
W6001111108	G1/4"	8	4
W6001121108	G3/8"	8	4
W6001121110	G3/8"	10	4
W6001131112	G1/2"	12	4



FLOW CONTROL VALVES

Unidirectional In-line Flow Control



To suit Cylinders

9148	Thread BSP	Mounting Thread
9041001	M5	M10 x 0.75
9041002	G1/8"	M12 x 1
9041003	G1/4"	M12 x 1
9041004	G3/8"	M15 x 1
9041005	G1/2"	M15 x 1

Bidirectional In-line Flow Control



To suit Cylinders

9148	Thread BSP	Mounting Thread
9041201	M5	M10 x 0.75
9041202	G1/8"	M12 x 1
9041203	G1/4"	M12 x 1
9041204	G3/8"	M15 x 1
9041205	G1/2"	M15 x 1

Unidirectional Flow Control



With Push-in Fittings

9148	Tube Ø mm	Mounting Thread
9041301	4	M9 x 0.75
9041316	6	M12 x 0.7
9041324	8	M15 x 1

Unidirectional Flow Control Fittings

► Flow Direction



Flow Direction Thread to Tube

9148	Thread BSP	Tube Ø mm
9041401	M5	4
9041402	G1/8"	4
9041408	G1/8"	6
9041409	G1/4"	6
9041410	G1/8"	8
9041411	G1/4"	8
9041412	G3/8"	8

Unidirectional Flow Control Fittings

► Flow Direction



Flow Direction Tube to Thread

9148	Thread BSP	Tube Ø mm
9041501	M5	4
9041502	G1/8"	4
9041508	G1/8"	6
9041509	G1/4"	6
9041510	G1/8"	8
9041511	G1/4"	8
9041512	G3/8"	8

Quick Exhaust Valves



BSP

9149	Thread BSP
9101201	1/8"
9201201	1/4"
9401201	1/2"



FUNCTIONAL FITTINGS

Line on Line is an exclusive range of products for mounting on pneumatic circuits. With these small, highly efficient components it is possible to perform all pneumatic functions at any point of the circuit.

Line on Line is ultra-modular; the components can be connected in parallel, in series or combined parallel/series.

All Line on Line products are available for pipe-pipe connection with integral push-in fittings, or for thread-pipe connection with a brass nickel-plated male thread and an integral push-in fitting.

The body is made of technopolymer, giving a product that is extremely lightweight and compact. One side of the body is marked with an indelible pneumatic symbol to facilitate identification and indicate the direction of flow.

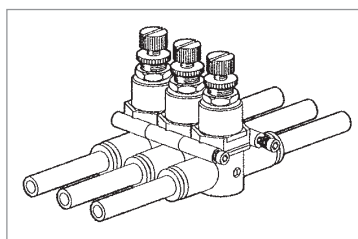

Parallel Lines

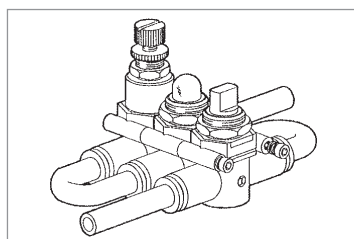

Serial Line Parallel Fittings

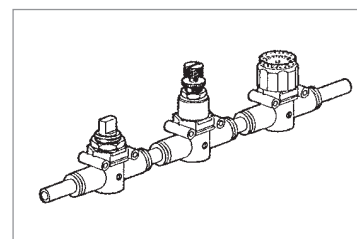

Serial Line In-line Fittings

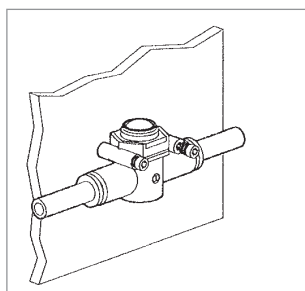

Wall Fixing

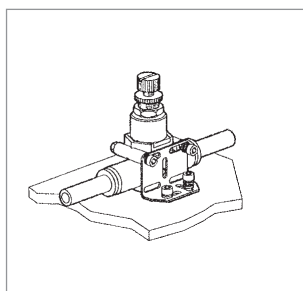
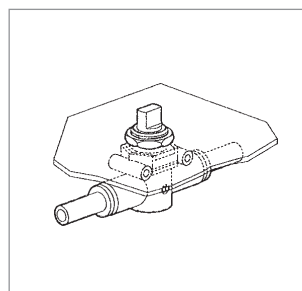
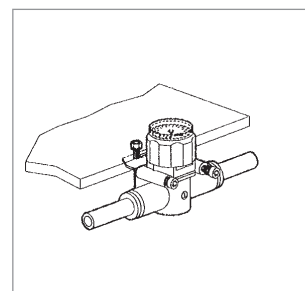

Plate Fixing



Panel Fixing



Under Wall Fixing

Technical Specifications

- Maximum operating pressure: 10 bar
- Temperature range: -20°C to +60°C
- Maximum flow rate on regulation at 6.3 bar: 155 NI/min (4mm), 450 NI/min (6mm), 850 NI/min (8mm)
- Adjustment: manual or using a screwdriver
- Internal system: tapered needle
- Recommended pipe: Rilson PA 11, nylon 6, polyamide 12, polypropylene
- Fluid: lubricated or non-lubricated filtered air

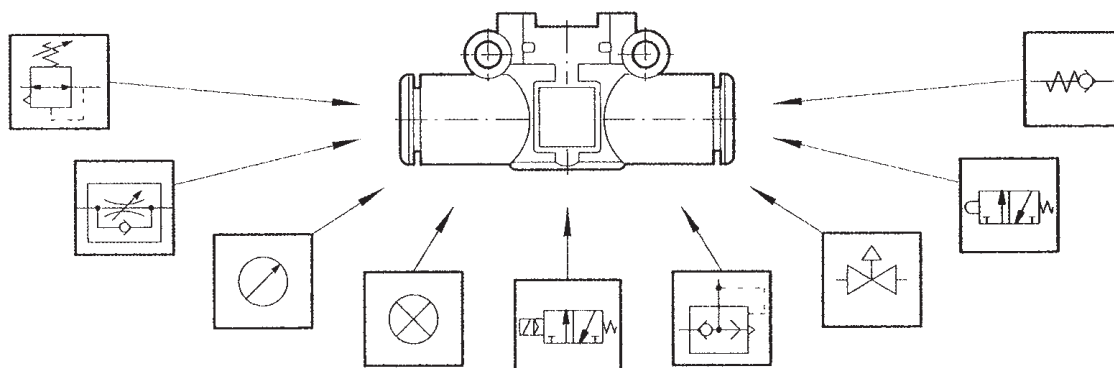

FUNCTIONAL FITTINGS

Line Mounted Pressure Regulator

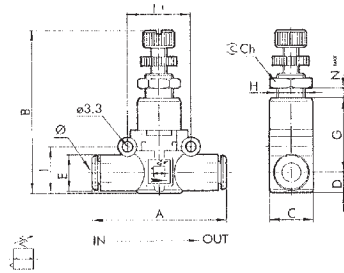

lineonline

Tube to Tube

9148	Ø	A	B	C	D	E
9061316	6	47	46-52	14.7	6.4	11.4
9061324	8	55.5	52-58	18.7	9.1	13.8

In-line Quick Exhaust Valve

Fig. A.

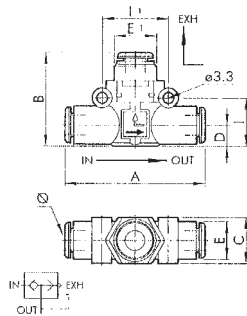
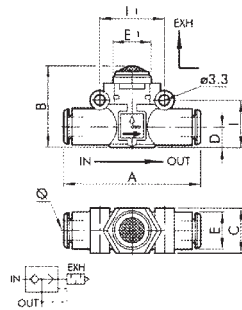

Fig. B.



lineonline

Tube to Tube

9148	Ø	Figure	A	B	C	D	E	E1	I	I1
9063016	6	A	47	29	14.7	6.4	11.4	13	14.6	20
9063024	8	A	55.5	35	18.7	9.1	13.8	15	18.7	24
9063116	6	B	47	25.5	14.7	6.4	11.4	14	14.6	20
9063124	8	B	55.5	31.5	18.7	9.1	13.8	18	18.7	24

In-line Quick Exhaust Valve



lineonline

Tube to Thread

9148	Ø	Figure	P	A	A1	B	C	D	E	E1	E2	I	I1	I2
9063308	6	1/8	6	57.3	27.8	25.5	14.7	6.4	14	11.4	14	14.6	20	12
9063309	6	1/4	8	60.3	28.8	25.5	14.7	6.4	18	11.4	14	14.6	20	14
9063310	8	1/8	6	65.5	31.8	31.5	18.7	9.1	15	13.8	18	18.7	24	13
9063311	8	1/4	8	69.7	34.2	31.5	18.7	9.1	18	13.8	18	18.7	24	14

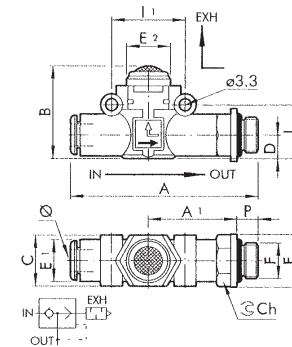

In-line Check Valve

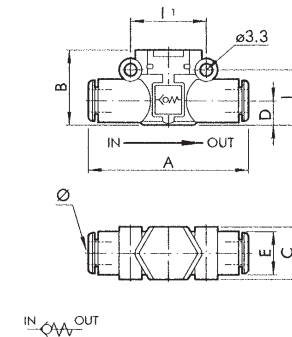

Tube to Tube

9148	Ø	A	B	C	D	E	I	I1
9064016	6	47	20	14.7	6.4	11.4	14.6	20
9064024	8	55.5	25.5	18.7	9.1	13.8	18.7	24

FUNCTIONAL FITTINGS

In-line Shut-off Valve

Technical Data

- Inlet Flow rate at 6.3 bar ΔP 1 bar:
280 NI/min (6mm), 470 NI/min (8mm)
- V2V L: on/off function
- V3V L: on/off function with vent

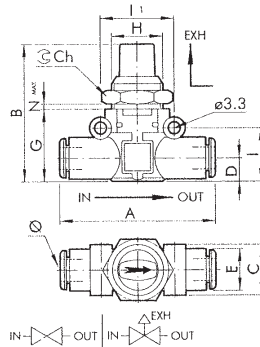

Tube to Tube

9148	Function	Ø	A	B	C	D	E	G	H	I	I1	Ch	Nmax
9065016	V2V L	6	47	41	14.7	6.4	11.4	21	M15 x 1	14.6	20	17	5.5
9066016	V3V L	6	47	41	14.7	6.4	11.4	21	M15 x 1	14.6	20	17	5.5
9065024	V2V L	8	55.5	46	18.7	9.1	13.8	26	M15 x 1	18.7	24	17	5.5
9066024	V3V L	8	55.5	46	18.7	9.1	13.8	26	M15 x 1	18.7	24	17	5.5

In-line Shut-off Valve, Lockable

Technical Data

- V2V L: on/off function
- V3V L: on/off function with vent

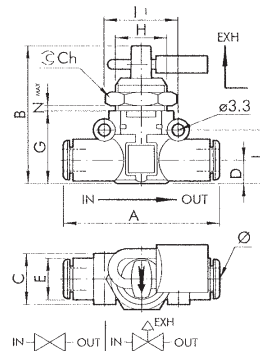
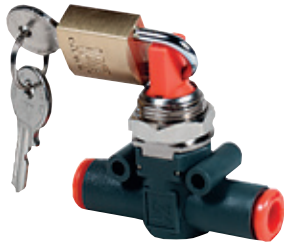

Tube to Tube

9148	Function	Ø	A	B	C	D	E	G	H	I	I1	Ch	Nmax
9065116	V2V L	6	47	41	14.7	6.4	11.4	21	M15 x 1	14.6	20	17	5.5
9066116	V3V L	6	47	41	14.7	6.4	11.4	21	M15 x 1	14.6	20	17	5.5
9065124	V2V L	8	55.5	46	18.7	9.1	13.8	26	M15 x 1	18.7	24	17	5.5
9066124	V3V L	8	55.5	46	18.7	9.1	13.8	26	M15 x 1	18.7	24	17	5.5

In-line Pressure Gauge

Technical Data

- Operating pressure: 12 bar
- Precision: +4% full scale

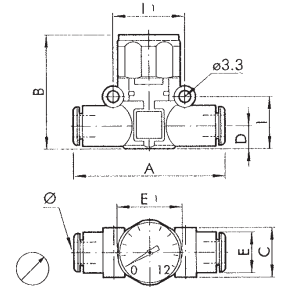

Tube to Tube

9148	Ø	A	B	C	D	E	E1	I	I1
9067016	6	47	35	14.7	6.4	11.4	23	14.6	20
9067024	8	55.5	41	18.7	9.1	13.8	23	18.7	24

Technical Data

- Operating pressure: 12 bar
- Precision: +4% full scale

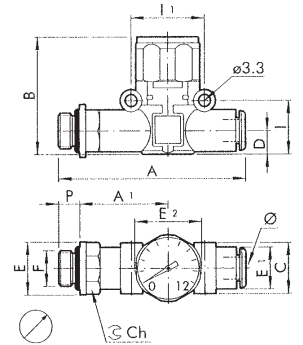

Thread to Tube

9148	Function	Ø	P	A	A1	B	C	D	E	E1	E2	I	I1	Ch
9067108	1/8	6	6	57.3	27.5	35	14.7	6.4	14	11.4	23	14.6	20	12
9067109	1/4	6	8	60.3	28.8	35	14.7	6.4	18	11.4	23	14.6	20	14
9067110	1/8	8	6	65.3	31.8	41	18.7	9.1	15	13.8	23	18.7	24	14
9067111	1/4	8	8	69.7	34.2	41	18.7	9.1	18	13.8	23	18.7	24	14

In-line Pressure Indicator

Technical Data

- Operating pressure: 2-12 bar
- A = Orange, V = Green

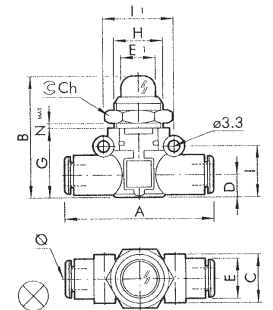

Tube to Tube

9148	Type	Ø	A	B	C	D	E	E1	G	H	I	I1	Ch	Nmax
9068016	A	6	47	37	14.7	6.4	11.4	10.6	21	M15 x 1	14.6	20	17	4.5
9068216	V	6	47	37	14.7	6.4	11.4	10.6	21	M15 x 1	14.6	20	17	4.5
9068024	A	8	55.5	41	18.7	9.1	13.8	10.6	26	M15 x 1	18.7	24	17	4.5
9068224	V	8	55.5	41	18.7	9.1	13.8	10.6	26	M15 x 1	18.7	24	17	4.5

FUNCTIONAL FITTINGS

In-line 3 Port Solenoid Valve, Silenced Exhaust

Technical Data

- Operating pressure: 2.5-7 bar
- Flow rate at 6.3 bar ΔP 0.5 bar: 270 NI/min (6mm), 500 NI/min (8mm)
- Voltage: 24V DC
- Power: 1.2W

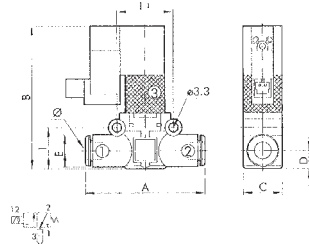

Tube to Tube

9148	Ø	A	B	C	D	E	I	I1
9069016	6	47	55.5	14.7	6.4	11.4	14.6	20
9069024	8	55.5	63.5	18.7	9.1	13.8	18.7	24

Technical Data

- Operating pressure: 2.5-7 bar
- Flow rate at 6.3 bar ΔP 0.5 bar: 270 NI/min, 500 NI/min
- Voltage: 24V DC
- Power: 1.2W

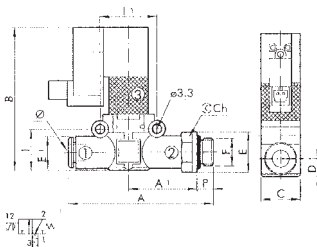

Thread to Tube

9148	Ø	F	P	A	A1	B	C	I	I1	Ch1
9069408	6	1/8	6	57.3	27.8	55.5	14.7	14.6	20	12
9069409	6	1/4	8	60.3	28.8	55.5	14.7	14.6	20	14
9069410	8	1/8	6	65.3	31.3	63.5	18.7	18.7	24	14
9069411	8	1/4	8	69.7	34.2	63.5	18.7	18.7	24	14

In-line 3 Port Solenoid Valve, Threaded Exhaust

Technical Data

- Operating pressure: 2.5 to 7 bar
- Flow rate at 6.3 bar ΔP 0.5 bar: 500 NI/min
- Voltage: 24V DC
- Power: 1.2W

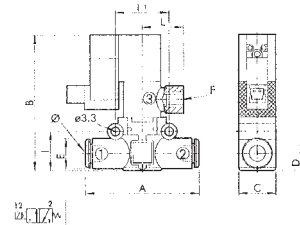

Tube to Tube

9148	Ø	A	B	C	D	E	E1	I	I1	L
9069224	8	55.5	63.5	18.7	9.1	13.8	1/8	18.7	24	21.5

In-line 3 Port Solenoid Valve, Silenced Exhaust

Technical Data

- Operating pressure: 2.5 to 7 bar
- Flow rate at 6.3 bar ΔP 0.5 bar: 270 NI/min, 500 NI/min
- Voltage: 24V DC
- Power: 1.2W

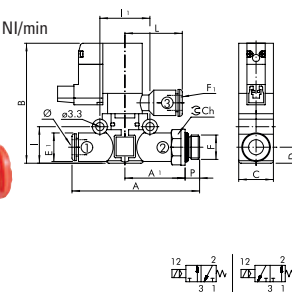
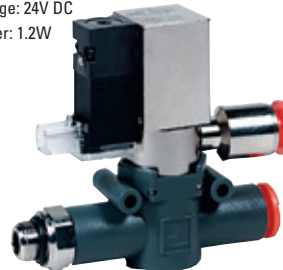

Tube to Thread

9148	Ø	F	P	A	A1	B	C	D	E	E1	F1	I	I1	L	Ch1
9069610	8	1/8	6	65.3	31.8	63.5	18.7	9.1	15	13.8	1/8	18.7	24	25.1	1
9069611	8	1/4	8	69.7	34.2	63.5	18.7	9.1	18	13.8	1/8	18.7	24	21.5	1

Electrical Connector



Plug-in

9148	Description
W0970512000	Plug-in Connector, 300mm Leads

Fixing Bracket

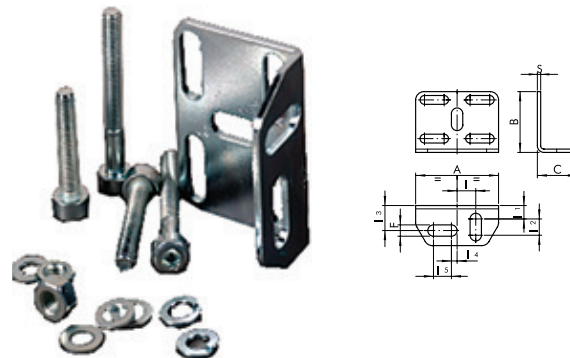

To suit All Line on Line Products

9148	A	B	C	F	I	I1	I2	13	14	15	S
9062110	30	22	14.5	4.2	6.8	4.8	5.9	9.1	2	6.5	1.2

U Tube



Tube

9148	OD mm
9062216	6
9062224	8

SERIES 7000 SUPER-RAPID COMPACT FITTINGS

Material: Technopolymer



Working Pressure:

-0.9 to 16 bar

Swivel Male Stud Elbows



Metric & BSPP

0158	OD mm	Thread
7522 4-M5	4	M5
7522 4-M7	4	M7
7522 4-1/8	4	1/8"
7522 4-1/4	4	1/4"
7522 6-M5	6	M5
7522 6-M7	6	M7
7522 6-1/8	6	1/8"
7522 6-1/4	6	1/4"
7522 8-1/8	8	1/8"
7522 8-1/4	8	1/4"
7522 8-3/8	8	3/8"
7522 10-1/4	10	1/4"
7522 10-3/8	10	3/8"
7522 10-1/2	10	1/2"
7522 12-1/4	12	1/4"
7522 12-3/8	12	3/8"
7522 12-1/2	12	1/2"
7522 16-1/2	16	1/2"
7522 16-3/4	16	3/4"

Tech Sheet 68274

Swivel Male Stud Extended Elbows



BSPP, Extended

0158	OD mm	Thread
7526 4-1/8	4	1/8"
7526 6-1/8	6	1/8"
7526 6-1/4	6	1/4"
7526 8-1/8	8	1/8"
7526 8-1/4	8	1/4"

Tech Sheet 68274

Swivel Male Stud Branch Tees



Metric & BSPP

0158	OD mm	Thread
7432 4-M5	4	M5
7432 4-1/8	4	1/8"
7432 6-M5	6	M5
7432 6-1/8	6	1/8"
7432 6-1/4	6	1/4"
7432 8-1/8	8	1/8"
7432 8-1/4	8	1/4"
7432 8-3/8	8	3/8"
7432 10-1/4	10	1/4"
7432 10-3/8	10	3/8"
7432 10-1/2	10	1/2"
7432 12-1/4	12	1/4"
7432 12-3/8	12	3/8"
7432 12-1/2	12	1/2"
7432 16-1/2	16	1/2"
7432 16-3/4	16	3/4"

Tech Sheet 68274

Swivel Male Stud Run Tees



BSPP

0158	OD mm	Thread
7442 4-1/8	4	1/8"
7442 6-1/8	6	1/8"
7442 6-1/4	6	1/4"
7442 8-1/8	8	1/8"
7442 8-1/4	8	1/4"
7442 8-3/8	8	3/8"
7442 10-1/4	10	1/4"
7442 10-3/8	10	3/8"
7442 12-3/8	12	3/8"
7442 12-1/2	12	1/2"
7442 16-1/2	16	1/2"
7442 16-3/4	16	3/4"

Tech Sheet 68274

Swivel Male Stud Ys



BSPP

0158	OD mm	Thread
7562 4-1/8	4	1/8"
7562 6-1/8	6	1/8"
7562 6-1/4	6	1/4"
7562 8-1/8	8	1/8"
7562 8-1/4	8	1/4"
7562 10-1/4	10	1/4"
7562 10-3/8	10	3/8"

Tech Sheet 68274

Swivel Male Stud Double Ys



BSPP

0158	OD mm	Thread
7572 4-1/8	4	1/8"
7572 4-1/4	4	1/4"
7572 6-1/8	6	1/8"
7572 6-1/4	6	1/4"

Tech Sheet 68274

SERIES 7000 SUPER-RAPID COMPACT FITTINGS

Material: Technopolymer



Working Pressure:
-0.9 to 16 bar

Tube x Tube Connectors



Equal Straights

0158	OD mm
7580 4	4
7580 6	6
7580 8	8
7580 10	10
7580 12	12

Tech Sheet 68274



Equal Elbows

0158	OD mm
7550 4	4
7550 6	6
7550 8	8
7550 10	10
7550 12	12
7550 16	16

Tech Sheet 68274



Equal Tees

0158	OD mm
7540 4	4
7540 6	6
7540 8	8
7540 10	10
7540 12	12
7540 16	16

Tech Sheet 68274



Equal Ys

0158	OD mm
7560 4	4
7560 6	6
7560 8	8
7560 10	10

Tech Sheet 68274



Unequal Ys

0158	OD mm	OD mm
7560 6-4	6	4
7560 8-6	8	6
7560 10-8	10	8

Tech Sheet 68274



Unequal Double Ys

0158	OD mm	OD mm
7575 6-4	6	4
7575 8-6	8	6

Tech Sheet 68274

Tube x Stem Connectors



Unequal Straights

0158	OD mm	Stem OD mm
7800 4-6	4	6
7800 4-8	4	8
7800 6-8	6	8
7800 6-10	6	10
7800 6-12	6	12
7800 8-10	8	10
7800 8-12	8	12
7800 10-12	10	12

Tech Sheet 68274



Elbows

0158	OD mm	Stem OD mm
7555 4-4	4	4
7555 6-6	6	6
7555 8-8	8	8
7555 10-10	10	10
7555 12-12	12	12

Tech Sheet 68274

Stem Connectors



Stem x Stem

0158	Stem OD mm
7950 4	4
7950 6	6
7950 8	8
7950 10	10
7950 12	12

Tech Sheet 68274

Reducing Manifolds



Tube x Tube

0158	Inlet OD mm	Outlet OD mm
7545 6-4	6	4
7545 8-6	8	6
7545 10-8	10	10

Tech Sheet 68274



Swivel Male, BSPP

0158	Inlet OD mm	Outlet OD mm	Thread
7542 6-4-1/8	6	4	1/8"
7542 6-4-1/4	6	4	1/4"
7542 8-6-1/8	8	6	1/8"
7542 8-6-1/4	8	6	1/4"
7542 10-8-1/4	10	8	1/4"
7542 10-8-3/8	10	8	3/8"

Tech Sheet 68274

SERIES 7000 SUPER-RAPID COMPACT FITTINGS

Material: Technopolymer

Working Pressure:
-0.9 to 16 bar

Single Banjo Bodies



BSPP

0158	OD mm	Thread
7610 4-1/8	4	1/8"
7610 6-1/8	6	1/8"
7610 6-1/4	6	1/4"
7610 8-1/8	8	1/8"
7610 8-1/4	8	1/4"
7610 10-1/4	10	1/4"
7610 10-3/8	10	3/8"
7610 12-3/8	12	3/8"

Tech Sheet 68274

Twin Banjo Bodies



BSPP

0158	OD mm	Thread
7640 4-1/8	4	1/8"
7640 6-1/8	6	1/8"
7640 6-1/4	6	1/4"
7640 8-1/8	8	1/8"
7640 8-1/4	8	1/4"
7640 10-1/4	10	1/4"

Tech Sheet 68274

Swivel Banjos, 1 Outlet



BSPP

0158	OD mm	Thread
7622 4-1/8	4	1/8"
7622 6-1/8	6	1/8"
7622 6-1/4	6	1/4"
7622 8-1/8	8	1/8"
7622 8-1/4	8	1/4"
7622 10-1/4	10	1/4"
7622 10-3/8	10	3/8"
7622 12-3/8	12	3/8"

Tech Sheet 68274

Swivel Twin Banjos, 2 Outlets



BSPP

0158	OD mm	Thread
7652 4-1/8	4	1/8"
7652 6-1/8	6	1/8"
7652 6-1/4	6	1/4"
7652 8-1/8	8	1/8"
7652 8-1/4	8	1/4"
7652 10-1/4	10	1/4"
7652 10-3/8	10	3/8"

Tech Sheet 68274

Double Adjustable Banjos, 2 Outlets



BSPP

0158	OD mm	Thread
7612 02-4-1/8	4	1/8"
7612 02-6-1/8	6	1/8"
7612 02-6-1/4	6	1/4"
7612 02-8-1/8	8	1/8"
7612 02-8-1/4	8	1/4"
7612 02-10-1/4	10	1/4"
7612 02-10-3/8	10	3/8"
7612 02-12-3/8	12	3/8"

Tech Sheet 68274

Double Adjustable Twin Banjos, 4 Outlets



BSPP

0158	OD mm	Thread
7642 02-4-1/8	4	1/8"
7642 02-6-1/8	6	1/8"
7642 02-6-1/4	6	1/4"
7642 02-8-1/8	8	1/8"
7642 02-8-1/4	8	1/4"
7642 02-10-1/4	10	1/4"

Tech Sheet 68274

Triple Adjustable Banjos, 3 Outlets



BSPP

0158	OD mm	Thread
7612 03-4-1/8	4	1/8"
7612 03-6-1/8	6	1/8"
7612 03-6-1/4	6	1/4"
7612 03-8-1/8	8	1/8"
7612 03-8-1/4	8	1/4"
7612 03-10-1/4	10	1/4"

Tech Sheet 68274

Triple Adjustable Twin Banjos, 6 Outlets



BSPP

0158	OD mm	Thread
7642 03-4-1/8	4	1/8"
7642 03-6-1/8	6	1/8"
7642 03-6-1/4	6	1/4"
7642 03-8-1/8	8	1/8"
7642 03-8-1/4	8	1/4"
7642 03-10-1/4	10	1/4"

Tech Sheet 68274

Banjo Bolts



Double Stem, BSPP

0158	Thread
7632 02-1/8	1/8"
7632 02-1/4	1/4"
7632 02-3/8	3/8"

Tech Sheet 68274

Triple Stem, BSPP

0158	Thread
7632 03-1/8	1/8"
7632 03-1/4	1/4"

Tech Sheet 68274





Push-in Fittings & Ring Main Systems

For
Ring Main
Systems
see section 8
page 1061



For Push-in
Fittings
see section 6
page 763

PUSH-IN FITTINGS, METRIC

Media: Compressed air. Suitable for vacuum.

Temperature at:	Pressure 5/32" – 5/16" 4mm – 8mm	Pressure 3/8" - 1/2": 10mm – 22mm
Air		
-20°C	16 bar	10 bar

Potable Liquids and Air		
+1°C	16 bar	10 bar
+20°C	16 bar	10 bar
+65°C	10 bar	7 bar

Straight Adaptors

Male Thread, Super Thread



1400	OD mm	Thread
LM0104M5	4	M5
RM010411	4	1/8"
RM010511	5	1/8"
RM010512	5	1/4"
RM010611	6	1/8"
RM010612	6	1/4"
RM010811	8	1/8"
RM010812	8	1/4"
RM010813	8	3/8"
RM011012	10	1/4"
RM011013	10	3/8"
RM011014	10	1/2"
RM011213	12	3/8"
RM011214	12	1/2"

Male Thread, Metric



1400	OD mm	Thread
RM0104M5	4	M5
RM0106M5	6	M5



Male Thread, BSPP

1400	OD mm	Thread
PM010411E	4	1/8"
PM010412E	4	1/4"
PM010511E	5	1/8"
PM010512E	5	1/4"
PM010611E	6	1/8"
PM010612E	6	1/4"
PM010811E	8	1/8"
PM010812E	8	1/4"
PM010813E	8	3/8"
PM011012E	10	1/4"
PM011013E	10	3/8"
PM011014E	10	1/2"
PM011213E	12	3/8"
PM011514E	15	1/2"



Male Thread, BSPT

1400	OD mm	Thread
PM010401E	4	1/8"
PM010402E	4	1/4"
PM010501E	5	1/8"
PM010502E	5	1/4"
PM010601E	6	1/8"
PM010602E	6	1/4"
PM010801E	8	1/8"
PM010802E	8	1/4"
PM010803E	8	3/8"
PM011002E	10	1/4"
PM011003E	10	3/8"
PM011004E	10	1/2"
PM011203E	12	3/8"
PM011204E	12	1/2"

Brass Straight Adaptors



Male Thread, BSPP

1400	OD mm	Thread
MM010411	4	1/8"
MM010611	6	1/8"



Male Super Thread

1400	OD mm	Thread
LM010411	4	1/8"

Equal Tees



Tube x Tube

1400	OD mm
LM0203E	3
PM0204E	4
PM0205E	5
PM0206E	6
PM0208E	8
PM0210E	10
PM0212E	12
PM0215E	15

Equal Elbows



Tube x Tube

1400	OD mm
LM0303E	3
PM0304E	4
PM0305E	5
PM0306E	6
PM0308E	8
PM0310E	10
PM0312E	12
PM0315E	15

Reducing Elbow Connectors



Tube x Tube

1400	OD mm	OD mm
PM210604E	6	4
PM210804E	8	4
PM210806E	8	6
PM211004E	10	4
PM211006E	10	6
PM211008E	10	8
PM211208E	12	8
PM211210E	12	10

PUSH-IN FITTINGS, METRIC

Female Adaptors



BSPP

1400	OD mm	Thread
PM450411E	4	1/8"
PM450611E	6	1/8"
PM450612E	6	1/4"
PM450812E	8	1/4"
PM451015FE	10	5/8"

Stem Elbows



Tube x Stem

1400	OD mm	Stem OD mm
PM220404E	4	4
PM220505E	5	5
PM220606E	6	6
PM220808E	8	8
PM221010E	10	10
PM221212E	12	12
PM221515E	15	15

Equal Straight Connectors



Tube x Tube

1400	OD mm
PM0404E	4
PM0405E	5
PM0406E	6
PM0408E	8
PM0410E	10

Reducing Straight Connectors



Tube x Tube

1400	OD mm	OD mm
PM200604E	6	4
PM200804E	8	4
PM200806E	8	6
PM201004E	10	4
PM201006E	10	6
PM201008E	10	8
PM201208E	12	8
PM201210E	12	10

Stem Adaptors



Super Thread, BSPP

1400	Stem OD mm	Thread
RM050411	4	1/8"
RM050412	4	1/4"
RM050512	5	1/4"
RM050611	6	1/8"
RM050612	6	1/4"
RM051013	10	3/8"
RM051014	10	1/2"
RM051213	12	3/8"

Metric



1400	Stem OD mm	Thread
RM0504M5	4	M5
RM0506M5	6	M5



BSPT

1400	Stem OD mm	Thread
PM050401E	4	1/8"
PM050402E	4	1/4"
PM050501E	5	1/8"
PM050502E	5	1/4"
PM050601E	6	1/8"
PM050602E	6	1/4"
PM050801E	8	1/8"
PM050802E	8	1/4"
PM050803E	8	3/8"
PM051002E	10	1/4"
PM051003E	10	3/8"
PM051004E	10	1/2"
PM051203E	12	3/8"
PM051204E	12	1/2"



BSPP

1400	Stem OD mm	Thread
PM050411E	4	1/8"
PM050412E	4	1/4"
PM050511E	5	1/8"
PM050512E	5	1/4"
PM050611E	6	1/8"
PM050612E	6	1/4"
PM050811E	8	1/8"
PM050812E	8	1/4"
PM050813E	8	3/8"
PM051012E	10	1/4"
PM051013E	10	3/8"
PM051014E	10	1/2"
PM051213E	12	3/8"
PM051214E	12	1/2"

Dividers



Tube x Tube

1400	OD mm
PM2304E	4
RM2306E	6
RM2308E	8
PM2310E	10

Bulkhead Adaptors

Media:

Compressed air. Suitable for vacuum.

Maximum bulkhead mounting torque 27Nm.



BSPP

1400	OD mm	Thread	Bulkhead
RM070612	6	1/4"	3/8"

Swivel Tees Offset Leg

Media:

Compressed Air. Suitable for vacuum.



BSPT

1400	OD mm	Thread
PM110601E	6	1/8"
PM110802E	8	1/4"
PM111003E	10	3/8"
PM111203E	12	3/8"
PM111204E	12	1/2"



BSPP Thread

1400	OD mm	Thread
PM110411E	4	1/8"
PM110511E	5	1/8"
PM110512E	5	1/4"
PM110611E	6	1/8"
PM110612E	6	1/4"
PM110811E	8	1/8"
PM110812E	8	1/4"
PM110813E	8	3/8"
PM111012E	10	1/4"
PM111013E	10	3/8"
PM111014E	10	1/2"
PM111213E	12	3/8"
PM111214E	12	1/2"

PUSH-IN FITTINGS, METRIC

Bulkhead Connectors



BSPP Thread

1400	OD mm	Thread
PM1204E	4	3/8"
PM1206E	6	3/8"
PM1208E	8	1/2"
PM1210E	10	1/2"
PM1212E	12	3/4"

Reducers



Tube x Stem

1400	Stem OD mm	Thread
PM060504E	5	4
PM060604E	6	4
PM060605E	6	5
PM060804E	8	4
PM060805E	8	5
PM060806E	8	6
PM061006E	10	6
PM061008E	10	8
PM061208E	12	8
PM061210E	12	10
PM061510E	15	10

Single Banjo Body



BSPP Thread

1400	OD mm	Thread
RM150411E	4	1/8"
RM150511E	5	1/8"
RM150811E	8	1/4"
RM151013E	10	3/8"
RM151214E	12	1/2"

Banjo Bolts



Single, BSPP Thread

1400	Thread
RM1611	1/8"
RM1614	1/2"

Media:

Compressed air. Suitable for vacuum.



Double, BSPP Thread

1400	Thread
RM1711	1/8"
RM1712	1/4"
RM1713	3/8"
RM1714	1/2"

Swivel Elbows



Super Thread, BSPP

1400	OD mm	Thread
RM090412	4	1/4"
RM090611	6	1/8"
RM090612	6	1/4"
RM090811	8	1/8"
RM090812	8	1/4"
RM091013	10	3/8"
RM091213	12	3/8"
RM091214	12	1/2"



Metric Thread

1400	OD mm	Thread
LM0904M5	4	M5
RM0904M5	4	M5
RM0905M5	5	M5
RM0906M5	6	M5

Plugs

Media:

Compressed Air. Suitable for vacuum.



Tube

1400	Stem OD mm	Colour
PM0804R	4	Red
PM0805R	5	Red
PM0806R	6	Red
PM0808R	8	Red
PM0810R	10	Red
PM0812R	12	Red
PM0815R	15	Black



BSPP Thread

1400	OD mm	Thread
PM090411E	4	1/8"
PM090412E	4	1/4"
PM090511E	5	1/8"
PM090512E	5	1/4"
PM090611E	6	1/8"
PM090612E	6	1/4"
PM090811E	8	1/8"
PM090812E	8	1/4"
PM090813E	8	3/8"
PM091012E	10	1/4"
PM091013E	10	3/8"
PM091014E	10	1/2"
PM091213E	12	3/8"
PM091214E	12	1/2"



BSPT Thread

1400	OD mm	Thread
PM090401E	4	1/8"
PM090402E	4	1/4"
PM090501E	5	1/8"
PM090502E	5	1/4"
PM090601E	6	1/8"
PM090602E	6	1/4"
PM090801E	8	1/8"
PM090802E	8	1/4"
PM090803E	8	3/8"
PM091002E	10	1/4"
PM091003E	10	3/8"
PM091004E	10	1/2"
PM091203E	12	3/8"
PM091204E	12	1/2"

PUSH-IN FITTINGS, METRIC

Swivel Tees Centre Leg



Super Thread, BSPP

1400	OD mm	Thread
RM100611	6	1/8"
RM100612	6	1/4"



BSPT Thread

1400	OD mm	Thread
PM100401E	4	1/8"
PM100402E	4	1/4"
PM100502E	5	1/4"
PM100601E	6	1/8"
PM100602E	6	1/4"
PM100801E	8	1/8"
PM100802E	8	1/4"
PM100803E	8	3/8"
PM101002E	10	1/4"
PM101003E	10	3/8"
PM101004E	10	1/2"
PM101203E	12	3/8"
PM101204E	12	1/2"



BSPP Thread

1400	OD mm	Thread
PM100411E	4	1/8"
PM100412E	4	1/4"
PM100511E	5	1/8"
PM100512E	5	1/4"
PM100611E	6	1/8"
PM100612E	6	1/4"
PM100811E	8	1/8"
PM100812E	8	1/4"
PM100813E	8	3/8"
PM101012E	10	1/4"
PM101013E	10	3/8"
PM101014E	10	1/2"
PM101213E	12	3/8"
PM101214E	12	1/2"

Tube to Hose Stem



Stem x Hose Tail

1400	Stem OD mm	To Suit Hose ID mm
PM250604E	6	4
PM250806E	8	6
PM251008E	10	8

Collet Covers



Colour Coding and Additional Security

The slip-on collet covers shown in this photograph prevent accidental removal or tampering with tubing. Tubing can be inserted with the collet cover already attached to the fittings or the cover can be slid into position afterwards. The cover is easily removed as and when required and comes in a variety of colours for colour-coding.

Colours available - suffix indicates colour

i.e. E = Black S = Grey
R = Red B = Blue
Y = Yellow G = Green

Please indicate, by suffix the colour required or black will be supplied.

Metric

1400	OD mm
PM1904E	4
PM1905E	5
PM1910E	10
PM1912E	12
PM1915E	15
PM1922E	22

Locking Clip



1400	OD mm
PMC1815R	15



For John Guest
Ring Main System
see pages 1088-1092



You might also need Nylon Tubing
see pages 913-917

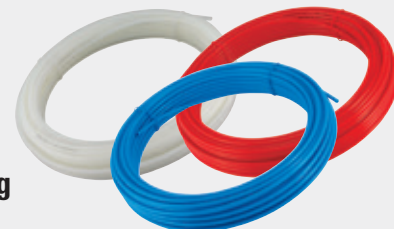

PUSH-IN FITTINGS, IMPERIAL

Media: Compressed air. Suitable for vacuum.

- Drink dispensers and pure water fittings

Temperature at:	Working Pressure 5/32"-5/16"	Working Pressure 3/8"-1/2"
+20°C	16 bar	10 bar
+23°C	16 bar	10 bar
+70°C	10 bar	7 bar

Straight Adaptors



Male Thread, BSPT

1400	OD	Thread
PM010401S	5/32"	1/8"
PM010402S	5/32"	1/4"
PI010601S	3/16"	1/8"
PI010801S	1/4"	1/8"
PI010802S	1/4"	1/4"
PM010801S	5/16"	1/8"
PM010802S	5/16"	1/4"
PM010803S	5/16"	3/8"
PI011202S	3/8"	1/4"
PI011203S	3/8"	3/8"
PI011603S	1/2"	3/8"
PI011604S	1/2"	1/2"

Male Thread, BSPP

1400	OD	Thread
PI010812S	1/4"	1/4"
PI011212S	3/8"	1/4"

Male Thread, NPT

1400	OD	Thread
PM010421S	5/32"	1/8"
PM010422S	5/32"	1/4"
PI010621S	3/16"	1/8"
PI010821S	1/4"	1/8"
PI010822S	1/4"	1/4"
PI010823S	1/4"	3/8"
PM010821S	5/16"	1/8"
PM010822S	5/16"	1/4"
PM010823S	5/16"	3/8"
PI011221S	3/8"	1/8"
PI011222S	3/8"	1/4"
PI011223S	3/8"	3/8"
PI011224S	3/8"	1/2"
PI011623S	1/2"	3/8"
PI011624S	1/2"	1/2"
PI012026S	5/8"	3/4"

Equal Straight Connectors



Tube x Tube

1400	OD
PM0404S	5/32"
PI0406S	3/16"
PI0408S	1/4"
PM0408S	5/16"
PI0412S	3/8"
PI0416S	1/2"

Equal Tees



Tube x Tube

1400	OD
PM0204S	5/32"
PI0206S	3/16"
PI0208S	1/4"
PM0208S	5/16"
PI0212S	3/8"
PI0216S	1/2"

Branch Reducing Tees



Tube x Tube

1400	OD	OD
PI301208S	3/8"	1/4"
PI301612S	1/2"	3/8"

Bulkhead Connectors



Tube x Tube

1400	OD
PI1206S	3/16"
PI1208S	1/4"
PM1208S	5/16"
PI1212S	3/8"
PI1216S	1/2"

Swivel Branch Tee, Leg



BSPT

1400	OD	Thread
PI100802S	1/4"	1/4"



Swivel Branch Tee, Run



BSPT

1400	OD	Thread
PM110801S	5/16"	1/8"

Reducing Bulkhead Connectors



Tube x Tube

1400	OD	OD
PI121208S	3/8"	1/4"

Stem Adaptors



Male Thread, BSPT

1400	Stem OD	Thread
PI050801S	1/4"	1/8"
PI050802S	1/4"	1/4"
PM050801S	5/16"	1/8"
PM050802S	5/16"	1/4"
PI051202S	3/8"	1/4"
PI051203S	3/8"	3/8"
PI051603S	1/2"	3/8"
PI051604S	1/2"	1/2"

Male Thread, BSPP

1400	Stem OD	Thread
PI051212S	3/8"	1/4"
PI051213S	3/8"	3/8"

Male Thread, NPT

1400	Stem OD	Thread
PM050421S	5/32"	1/8"
PM050422S	5/32"	1/4"
PI050621S	3/16"	1/8"
PI050821S	1/4"	1/8"
PI050822S	1/4"	1/4"
PI050823S	1/4"	3/8"
PM050821S	5/16"	1/8"
PM050822S	5/16"	1/4"
PM050823S	5/16"	3/8"
PI051222S	3/8"	1/4"
PI051223S	3/8"	3/8"
PI051623S	1/2"	3/8"
PI051624S	1/2"	1/2"

PUSH-IN FITTINGS, IMPERIAL



John Guest

Equal Elbows



Tube x Tube

1400	OD
PM0304S	5/32"
PI0306S	3/16"
PI0308S	1/4"
PM0308S	5/16"
PI0312S	3/8"
PI0316S	1/2"

Reducing Elbows



Tube x Tube

1400	OD	OD
PM210804S	5/16"	5/32"
PI211006S	5/16"	3/16"
PI211008S	5/16"	1/4"
PI211206S	3/8"	3/16"
PI211208S	3/8"	1/4"
PI211210S	3/8"	5/16"
PI211610S	1/2"	5/16"
PI211612S	1/2"	3/8"

Stem Elbows



Tube x Stem

1400	Stem OD	Thread
PM220404S	5/32"	5/32"
PI220606S	3/16"	3/16"
PI220808S	1/4"	1/4"
PM220808S	5/16"	5/16"
PI221206S	3/8"	3/16"
PI221208S	3/8"	1/4"
PI221210S	3/8"	5/16"
PI221212S	3/8"	3/8"
PI221616S	1/2"	1/2"

Rigid Elbows



Male Thread, NPT

1400	OD	Thread
PI480821S	1/4"	1/8"
PI480822S	1/4"	1/4"
PI480823S	1/4"	3/8"
PI481022S	5/16"	1/4"
PI481023S	5/16"	3/8"
PI481222S	3/8"	1/4"
PI481223S	3/8"	3/8"
PI482024S	5/8"	1/2"

Swivel Elbows



Male Thread, BSPT

1400	OD	Thread
PI090801S	1/4"	1/8"
PI090802S	1/4"	1/4"
PM090801S	5/16"	1/8"
PM090803S	5/16"	3/8"
PI091202S	3/8"	1/4"
PI091203S	3/8"	3/8"
PI091603S	1/2"	3/8"
PI091604S	1/2"	1/2"

Male Thread, NPT

1400	OD	Thread
PM090421S	5/32"	1/8"
PI090621S	3/16"	1/8"
PI090822S	1/4"	1/4"
PI091623S	1/2"	3/8"
PI091624S	1/2"	1/2"

Plugs



Tube

1400	Stem OD
PM0804S	5/32"
PI0806S	3/16"
PI0808S	1/4"
PM0808S	5/16"
PI0812S	3/8"
PI0816S	1/2"

Female Adaptors



BSPP

1400	OD	Thread
PI451014FS	5/16"	1/2"
PI451213S	3/8"	3/8"
PI451214FS	3/8"	1/2"
PI451613S	1/2"	3/8"



NPT

1400	OD	Thread
PI450822S	1/4"	1/4"
PI451222S	3/8"	1/4"

Reducers



Tube x Stem

1400	Stem OD	OD
PI060605S	3/16"	5/32"
PI061006S	5/16"	3/16"
PI061008S	5/16"	1/4"
PI061206S	3/8"	3/16"
PI061208S	3/8"	1/4"
PI061210S	3/8"	5/16"
PI061610S	1/2"	5/16"
PI061612S	1/2"	3/8"

PUSH-IN FITTINGS, IMPERIAL



Dividers



2 Way, Tube x Tube

1400	OD
PI2308S	1/4"
PI2312S	3/8"
PI2316S	1/2"



Reducing 2 Way, Tube x Tube

1400	OD A	OD B
PI241210S	3/8"	5/16"



Reducing 3 Way, Tube x Tube

1400	OD A	OD B
PI491612S	1/2"	3/8"

Enlargers



Tube x Stem

1400	OD	Stem OD
PI131012S	3/8"	5/16"
PI131216S	1/2"	3/8"

Cross



Tube x Tube

1400	OD
PI4712S	3/8"

U-Bends



Tube x Tube

1400	OD
PIUB16S	1/2"

End Stops



1400	OD
PI4608S	1/4"
PI4612S	3/8"

Tube to Hose Stems



Stem x Hose Tail

1400	Stem OD	To Suit Hose ID
PI250806S	1/4"	3/16"
PI250808S	1/4"	1/4"
PI250810S	1/4"	5/16"
PI251006S	5/16"	3/16"
PI251008S	5/16"	1/4"
PM250808S	5/16"	5/16"
PI251012S	5/16"	3/8"
PI251208S	3/8"	1/4"
PI251210S	3/8"	5/16"
PI251212S	3/8"	3/8"
PI251216S	3/8"	1/2"
PI251612S	1/2"	3/8"
PI251616S	1/2"	1/2"

Tube Hose to Elbows



Stem x Hose Tail

1400	Stem OD	To Suit Hose ID
PI290808S	1/4"	1/4"
PI290810S	1/4"	5/16"
PI291008S	5/16"	1/4"
PM290808S	5/16"	5/16"
PI291208S	3/8"	1/4"
PI291210S	3/8"	5/16"

Reducing Straight Connectors



Tube x Tube

1400	OD A	OD B
PI200806S	1/4"	3/16"
PM200804S	5/16"	5/32"
PI201006S	5/16"	3/16"
PI201008S	5/16"	1/4"
PI201206S	3/8"	3/16"
PI201208S	3/8"	1/4"
PI201210S	3/8"	5/16"
PI201610S	1/2"	5/16"
PI201612S	1/2"	3/8"

Flow Bend Tube Clips



90°

1400	OD mm	OD
PM2608S	8	5/16"
PM2610S	10	3/8"

Tube Supports



Tube

1400	To Suit Hose ID
TSI250S	1/4"
TSI312S	5/16"
TSI375S	3/8"

Locking Clip



1400	OD
PIC1808R	1/4"
PIC1812R	3/8"

Collet Covers



Imperial

1400	OD
PM1904S	5/32"
PI1908S	1/4"
PM1908S	5/16"
PI1916S	1/2"

ALL METAL PUSH-IN FITTINGS

One Touch



Features:

- Convenient One Touch fittings provide instant connections
- Light manual pressure on the collet ring is all that is required to instantly disconnect each tube; no special tool is required
- Nickel-plated brass ensures anti-corrosion and anti-contamination



Working Temperature:
-10°C to +60°C



Working Pressure
-0.8 bar to 8 bar*

*Dependent upon tubing specification.

Construction:

Resin Body: Nickel-plated brass

Packing: Nitrile

Back O-Ring: POM

O-Ring: Nitrile

Collet Ring: Nickel-plated brass

ALL METAL PUSH-IN FITTINGS

One Touch Emergency Fittings Kits



Convenient, compact boxes containing a selection of popular FT Pro One Touch metal push-in fittings along with handy tube cutter.

Available in three sizes: 6mm, 8mm and 10mm. Can be used with nylon 6, 11, 12, and polyurethane (ester and ether).

 **Working Temperature:**
-10°C to +60°C*

 **Working Pressure:**
0.8 to 8 bar*

Media:
Air and vacuum only.

Metal Push-in

0315	OD mm
FTP-06MMBOX-M	6
FTP-08MMBOX-M	8
FTP-10MMBOX-M	10

Tech Sheet 3130

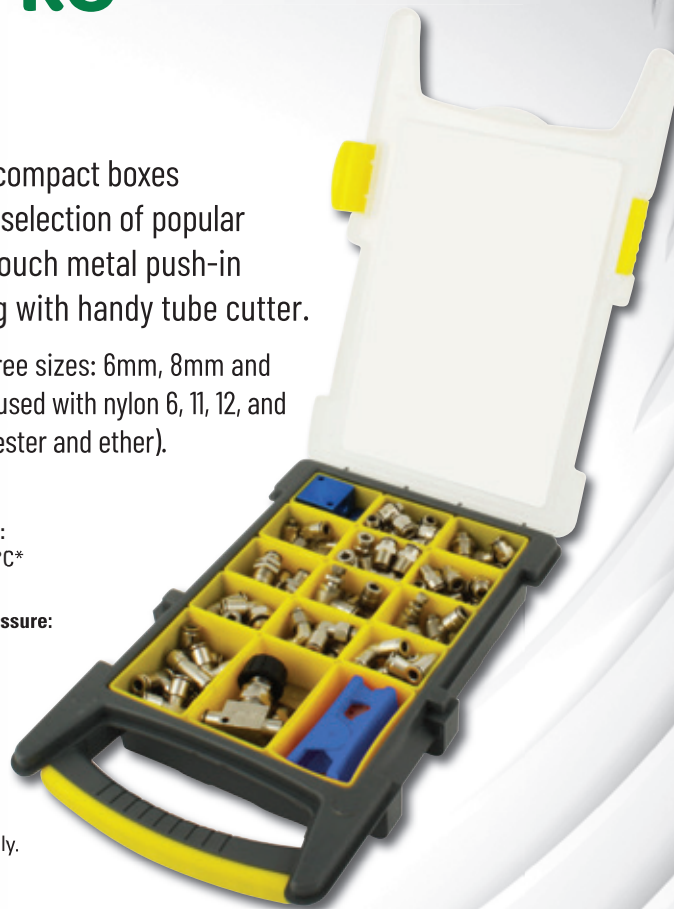

Contents:

6mm

Metal Push-in Fittings & Tube Cutter

1 x Tube Cutter KTC-1	2 x Shut Off Valves MNSF06	10 x Equal Tees MPUT-6	
8 x Equal Elbows MPUL-6	8 x 1/8" BSPP Male Stud Elbows MPL6-G01	5 x 1/4" BSPP Male Stud Elbows MPL6-G02	
2 x 1/8" BSPT Speed Controllers MNSE6-G01	2 x 1/4" BSPT Speed Controllers MNSE6-G02	10 x Equal Connectors MPUC-6	2 x Equal Bulkheads MPM-6
10 x 1/8" BSPT Male Studs MPC6-01	10 x 1/4" BSPT Male Studs MPC6-02	5 x M5 BSPT Male Studs MPC6-M5	
10 x 1/8" BSPP Male Studs MPC6-G01	10 x 1/4" BSPP Male Studs MPC6-G02	4 x 1/8" Manifolds KMDS-1/8	

8mm

Metal Push-in Fittings & Tube Cutter

1 x Tube Cutter KTC-1	2 x Shut Off Valves MNSF08	6 x Equal Tees MPUT-8	2 x Equal Bulkheads MPM-8
6 x Equal Elbows MPUL-8	6 x 1/8" BSPP Male Stud Elbows MPL8-G01	5 x 1/4" BSPP Male Stud Elbows MPL8-G02	
2 x 1/8" BSPT Speed Controllers MNSE8-G01	2 x 1/4" BSPT Speed Controllers MNSE8-G02	10 x Equal Connectors MPUC-8	
10 x 1/8" BSPT Male Studs MPC8-01	10 x 1/4" BSPT Male Studs MPC8-02	8 x 3/8" BSPT Male Studs MPC8-03	
8 x 1/8" BSPP Male Studs MPC8-G01	8 x 1/4" BSPP Male Studs MPC8-G02	4 x 1/8" Manifolds KMDS-1/8	

10mm

Metal Push-in Fittings & Tube Cutter

1 x Tube Cutter KTC-1	1 x Shut Off Valve MNSF10	4 x Equal Tees MPUT-10
2 x Equal Elbows MPUL-10	2 x 1/4" BSPP Male Stud Elbows MPL10-G01	2 x 3/8" BSPP Male Stud Elbows MPL10-G03
2 x 1/4" BSPT Speed Controllers MNSE10-G02	1 x 3/8" BSPT Speed Controller MNSE10-G03	6 x Equal Connectors MPUC-10
8 x 1/4" BSPT Male Studs MPC10-02	10 x 3/8" BSPT Male Studs MPC10-03	2 x Equal Bulkheads MPM-10
8 x 1/4" BSPP Male Studs MPC10-G02	5 x 3/8" BSPP Male Studs MPC10-G03	1 x 1/4" Manifolds KMDS-1/4

*Dependent upon tubing specification.

ONE TOUCH ALL METAL PUSH-IN FITTINGS



Working Temperature:
-10°C to +60°C
(dependent upon
tubing specification)

Working Pressure:
0.8 to 8 bar (dependent
upon tubing specification)

Tube connection and disconnection can be repeated several times and is performed with one hand, without the use of tools. Nickel plated brass bodies ensures anti-corrosion and anti-contamination.

Material: Body and Collet: Nickel plated brass
O-Ring: Nitrile
Threads: BSPT, BSPP and metric
Tube to Connect: PU, PE, nylon 6-11-12
Fluid: Compressed air

Male Studs



Male Thread, Metric & BSPT

0315	OD mm	Thread
MPC4-M5	4	M5
MPC4-01	4	1/8"
MPC4-M6	4	M6
MPC4-02	4	1/4"
MPC6-M5	6	M5
MPC6-01	6	1/8"
MPC6-M6	6	M6
MPC6-02	6	1/4"
MPC8-01	8	1/8"
MPC8-02	8	1/4"
MPC8-03	8	3/8"
MPC10-02	10	1/4"
MPC10-03	10	3/8"
MPC10-04	10	1/2"
MPC12-02	12	1/4"
MPC12-03	12	3/8"
MPC12-04	12	1/2"

Tech Sheet 3130



Male Thread, BSPP

0315	OD mm	Thread
MPC4-G01	4	1/8"
MPC4-G02	4	1/4"
MPC6-G01	6	1/8"
MPC6-G02	6	1/4"
MPC6-G03	6	3/8"
MPC6-G04	6	1/2"
MPC8-G01	8	1/8"
MPC8-G02	8	1/4"
MPC8-G03	8	3/8"
MPC8-G04	8	1/2"
MPC10-G02	10	1/4"
MPC10-G03	10	3/8"
MPC10-G04	10	1/2"
MPC12-G02	12	1/4"
MPC12-G03	12	3/8"
MPC12-G04	12	1/2"
MPC14-G03	14	3/8"
MPC14-G04	14	1/2"

Tech Sheet 3130

Male Hex Studs



Male Super Thread

0315	OD mm	Thread
MPCS4-G01	4	1/8"
MPCS4-G02	4	1/4"
MPCS6-G01	6	1/8"
MPCS6-G02	6	1/4"
MPCS6-G03	6	3/8"
MPCS6-G04	6	1/2"
MPCS8-G01	8	1/8"
MPCS8-G02	8	1/4"
MPCS8-G03	8	3/8"
MPCS8-G04	8	1/2"
MPCS10-G02	10	1/4"
MPCS10-G03	10	3/8"
MPCS10-G04	10	1/2"
MPCS12-G02	12	1/4"
MPCS12-G03	12	3/8"
MPCS12-G04	12	1/2"
MPCS14-G03	14	3/8"
MPCS14-G04	14	1/2"

Male Round Studs



Male Super Thread

0315	OD mm	Thread
MPCS4-M5	4	M5
MPCS4-01	4	1/8"
MPCS6-M5	6	M5
MPCS6-01	6	1/8"
MPCS6-02	6	1/4"
MPCS8-01	8	1/8"
MPCS8-02	8	1/4"

Female Studs



Female Thread, BSPP

0315	OD mm	Thread
MPCF4-G01	4	1/8"
MPCF4-G02	4	1/4"
MPCF6-G01	6	1/8"
MPCF6-G02	6	1/4"
MPCF8-G01	8	1/8"
MPCF8-G02	8	1/4"
MPCF8-G03	8	3/8"
MPCF10-G02	10	1/4"
MPCF10-G03	10	3/8"
MPCF10-G04	10	1/2"
MPCF12-G02	12	1/4"
MPCF12-G03	12	3/8"
MPCF12-G04	12	1/2"

Tech Sheet 3130

Female Bulkhead Connectors



Female Thread, BSPP

0315	OD mm	Thread
MPMF6-G01	6	1/8"
MPMF6-G02	6	1/4"

Tech Sheet 3130

Female Swivel Elbows



Female Thread, BSPP

0315	OD mm	Thread
MPLF4-G01	4	1/8"
MPLF6-G01	6	1/8"
MPLF6-G02	6	1/4"
MPLF8-G02	8	1/4"
MPLF8-G04	8	1/2"
MPLF10-G02	10	1/4"

Tech Sheet 3130

ONE TOUCH ALL METAL PUSH-IN FITTINGS



Working Temperature:
-10°C to +60°C
(dependent upon
tubing specification)



Working Pressure:
0.8 to 8 bar (dependent
upon tubing specification)

Tube connection and disconnection can be repeated several times and is performed with one hand, without the use of tools. Nickel plated brass bodies ensures anti-corrosion and anti-contamination.

Material: Body and Collet: Nickel plated brass
O-Ring: Nitrile
Threads: BSPT, BSPP and metric
Tube to Connect: PU, PE, nylon 6-11-12
Fluid: Compressed air

Male Stud Swivel Elbows



Male Thread, Metric & BSPT

0315	OD mm	Thread
MPL4-01	4	1/8"
MPL6-01	6	1/8"
MPL6-02	6	1/4"
MPL8-01	8	1/8"
MPL8-02	8	1/4"
MPL8-03	8	3/8"
MPL8-04	8	1/2"
MPL10-02	10	1/4"
MPL10-03	10	3/8"
MPL10-04	10	1/2"
MPL12-02	12	1/4"
MPL12-03	12	3/8"
MPL12-04	12	1/2"
5711114-3/8	14	3/8"
5711114-1/2	14	1/2"

Tech Sheet 3130



Male Thread, BSPP

0315	OD mm	Thread
MPL4-M5	4	M5
MPL4-G01	4	1/8"
MPL4-G02	4	1/4"
MPL6-M5	6	M5
MPL6-G01	6	1/8"
MPL6-G02	6	1/4"
MPL8-G01	8	1/8"
MPL8-G02	8	1/4"
MPL8-G03	8	3/8"
MPL8-G04	8	1/2"
MPL10-G02	10	1/4"
MPL10-G03	10	3/8"
MPL10-G04	10	1/2"
MPL12-G02	12	1/4"
MPL12-G03	12	3/8"
MPL12-G04	12	1/2"
MPL14-G03	14	3/8"
MPL14-G04	14	1/2"

Tech Sheet 3130



Extended Male Thread, BSPP

0315	OD mm	Thread
MPLL4-G01	4	1/8"
MPLL6-G01	6	1/8"
MPLL6-G02	6	1/4"
MPLL8-G01	8	1/8"
MPLL8-G02	8	1/4"
MPLL8-G03	8	3/8"
MPLL10-G02	10	1/4"
MPLL10-G03	10	3/8"
MPLL10-G04	10	1/2"
MPLL12-G02	12	1/4"
MPLL12-G03	12	3/8"
MPLL12-G04	12	1/2"

Tech Sheet 3130

Male Stud Swivel Tees



Branch Male Thread, BSPP

0315	OD mm	Thread
MPB4-M5	4	M5
MPB4-G01	4	1/8"
MPB4-G02	4	1/4"
MPB6-M5	6	M5
MPB6-G01	6	1/8"
MPB6-G02	6	1/4"
MPB8-G01	8	1/8"
MPB8-G02	8	1/4"
MPB8-G03	8	3/8"
MPB8-G04	8	1/2"
MPB10-G02	10	1/4"
MPB10-G03	10	3/8"
MPB10-G04	10	1/2"
MPB12-G03	12	3/8"
MPB12-G04	12	1/2"
MPB14-G03	14	3/8"
MPB14-G04	14	1/2"

Tech Sheet 3130

Single Banjos



Male Thread, Metric & BSPP

0315	OD mm	Thread
MPH4-M5	4	M5
MPH4-G01	4	1/8"
MPH6-G01	6	1/8"
MPH8-G01	8	1/8"
MPH8-G02	8	1/4"

Tech Sheet 3130

Speed Control Valves



Tube x Metric & BSPP

0315	OD mm	Thread
MNSE4-M5	4	M5
MNSE4-G01	4	1/8"
MNSE4-G02	4	1/4"
MNSE6-G01	6	1/8"
MNSE6-G02	6	1/4"
MNSE8-G01	8	1/8"
MNSE8-G02	8	1/4"
MNSE8-G03	8	3/8"
MNSE10-G02	10	1/4"
MNSE10-G03	10	3/8"
MNSE10-G04	10	1/2"
MNSE12-G02	12	1/4"
MNSE12-G03	12	3/8"
MNSE12-G04	12	1/2"

Tech Sheet 3130

ONE TOUCH ALL METAL PUSH-IN FITTINGS



Working Temperature:
-10°C to +60°C
(dependent upon
tubing specification)

Working Pressure:
0.8 to 8 bar (dependent
upon tubing specification)

Tube connection and disconnection can be repeated several times and is performed with one hand, without the use of tools. Nickel plated brass bodies ensures anti-corrosion and anti-contamination.

Material: Body and Collet: Nickel plated brass
O-Ring: Nitrile
Threads: BSPT, BSPP and metric
Tube to Connect: PU, PE, nylon 6-11-12
Fluid: Compressed air

Tube x Tube Connectors

Equal Straights

0315	OD mm
MPUC-4	4
MPUC-6	6
MPUC-8	8
MPUC-10	10
MPUC-12	12
MPUC-14	14

Tech Sheet 3130

Unequal Straights

0315	OD mm	OD mm
MPG6-4	6	4
MPG8-6	8	6
MPG10-8	10	8
MPG12-10	12	10

Tech Sheet 3130

Equal Elbows

0315	OD mm
MPUL-4	4
MPUL-6	6
MPUL-8	8
MPUL-10	10
MPUL-12	12
MPUL-14	14

Tech Sheet 3130

Equal Tees

0315	OD mm
MPUT-4	4
MPUT-6	6
MPUT-8	8
MPUT-10	10
MPUT-12	12
MPUT-14	14

Tech Sheet 3130

Equal Ys

0315	OD mm
MPY-6	6
MPY-8	8

Tech Sheet 3130

Equal Bulkheads

0315	OD mm
MPM-4	4
MPM-6	6
MPM-8	8
MPM-10	10
MPM-12	12

Tech Sheet 3130

Tube x Stem Connectors

Straight, Tube x Stem

0315	Stem OD mm	OD mm
MPJG6-4	6	4
MPJG8-4	8	4
MPJG8-6	8	6
MPJG10-4	10	4
MPJG10-6	10	6
MPJG10-8	10	8
MPJG12-8	12	8
MPJG12-10	12	10

Tech Sheet 3130

Standpipes

Male Thread, BSPP

0315	Stem OD mm	Thread
MPCJ4-G01	4	1/8"
MPCJ4-G02	4	1/4"
MPCJ6-G01	6	1/8"
MPCJ6-G02	6	1/4"
MPCJ8-G02	8	1/4"
MPCJ8-G03	8	3/8"
MPCJ8-G04	8	1/2"
MPCJ10-G02	10	1/4"
MPCJ10-G03	10	3/8"
MPCJ10-G04	10	1/2"
MPCJ12-G02	12	1/4"
MPCJ12-G03	12	3/8"
MPCJ12-G04	12	1/2"

Tech Sheet 3130

Female Thread, BSPP

0315	Stem OD mm	Thread
MPCFJ4-G01	4	1/8"
MPCFJ4-G02	4	1/4"
MPCFJ6-G01	6	1/8"
MPCFJ6-G02	6	1/4"
MPCFJ8-G02	8	1/4"
MPCFJ8-G03	8	3/8"
MPCFJ8-G04	8	1/2"
MPCFJ10-G02	10	1/4"
MPCFJ10-G03	10	3/8"
MPCFJ10-G04	10	1/2"
MPCFJ12-G02	12	1/4"
MPCFJ12-G03	12	3/8"
MPCFJ12-G04	12	1/2"

Tech Sheet 3130

Shut Off Valves

Tube x Tube

0315	OD mm
MNSF04	4
MNSF06	6
MNSF08	8
MNSF10	10
MNSF12	12

Tech Sheet 3130

LF 3600® PUSH-IN FITTINGS

All metal new LF 3600 (except sealing components) is compatible with many liquids and gases of average aggressiveness and is ideal for environments that require mechanical strength-incorporating high phosphorus chemical nickel plating that conforms to FDA standard (FOOD AND DRUG ADMINISTRATION).

 **Working Temperature:**
-20°C to +120°C

 **Maximum Working Pressure for Compressed Air:**
20 bar



NOTE: Ideal for food applications.

These fittings represents only part of this new range, for full details please speak to our technical department.



Male Stud Fittings



BSPT

1014	OD mm	Thread
LE-3675 04 10	4	1/8"
LE-3675 04 13	4	1/4"
LE-3675 06 10	6	1/8"
LE-3675 06 13	6	1/4"
LE-3675 08 10	8	1/8"
LE-3675 08 13	8	1/4"
LE-3675 08 17	8	3/8"
LE-3675 10 13	10	1/4"
LE-3675 10 17	10	3/8"
LE-3675 10 21	10	1/2"
LE-3675 12 13	12	1/4"
LE-3675 12 17	12	3/8"
LE-3675 12 21	12	1/2"
LE-3675 14 17	14	3/8"
LE-3675 14 21	14	1/2"

Tech Sheet 1528



Standpipe, BSPT

1014	Stem OD mm	Thread
LE-3621 04 10	4	1/8"
LE-3621 06 10	6	1/8"
LE-3621 06 13	6	1/4"
LE-3621 08 10	8	1/8"
LE-3621 08 13	8	1/4"
LE-3621 10 13	10	1/4"
LE-3621 10 17	10	3/8"
LE-3621 12 17	12	3/8"
LE-3621 12 21	12	1/2"

Tech Sheet 1528



Elbow, BSPT

1014	OD mm	Thread
LE-3609 04 10	4	1/8"
LE-3609 04 13	4	1/4"
LE-3609 06 10	6	1/8"
LE-3609 06 13	6	1/4"
LE-3609 08 10	8	1/8"
LE-3609 08 13	8	1/4"
LE-3609 08 17	8	3/8"
LE-3609 10 13	10	1/4"
LE-3609 10 17	10	3/8"
LE-3609 12 13	12	1/4"
LE-3609 12 17	12	3/8"
LE-3609 12 21	12	1/2"
LE-3609 14 21	14	1/2"

Tech Sheet 1528



Hexagon, Metric & BSPP

1014	OD mm	Thread
LE-3601 04 10	4	1/8"
LE-3601 04 52	4	M6 x 1
LE-3601 04 13	4	1/4"
LE-3601 04 56	4	M8 x 1
LE-3601 06 19	6	M5 x 0.8
LE-3601 06 10	6	1/8"
LE-3601 06 60	6	M10 x 1
LE-3601 06 13	6	1/4"
LE-3601 08 10	8	1/8"
LE-3601 08 13	8	1/4"
LE-3601 08 17	8	3/8"
LE-3601 10 13	10	1/4"
LE-3601 10 17	10	3/8"
LE-3601 10 21	10	1/2"
LE-3601 12 13	12	1/4"
LE-3601 12 17	12	3/8"
LE-3601 12 21	12	1/2"
LE-3601 14 17	14	3/8"
LE-3601 14 21	14	1/2"

Tech Sheet 1528



Metric

1014	OD mm	Thread
LE-3681 04 19	4	M5 x 0.8

Tech Sheet 1528



Extended Male Stud Elbow, Metric & BSPP

1014	OD mm	Thread
LE-3669 04 19	4	M5 x 0.8
LE-3669 04 10	4	1/8"
LE-3669 06 10	6	1/8"
LE-3669 06 13	6	1/4"
LE-3669 08 10	8	1/8"
LE-3669 08 13	8	1/4"
LE-3669 10 13	10	1/4"
LE-3669 10 17	10	3/8"
LE-3669 12 17	12	3/8"
LE-3669 14 21	14	1/2"

Tech Sheet 1528



Standpipe, Metric & BSPP

1014	Stem OD mm	Thread
LE-3631 04 19	4	M5 x 0.8
LE-3631 04 10	4	1/8"
LE-3631 06 10	6	1/8"
LE-3631 06 13	6	1/4"
LE-3631 08 13	8	1/4"
LE-3631 10 13	10	1/4"
LE-3631 10 17	10	3/8"
LE-3631 10 21	10	1/2"
LE-3631 12 17	12	3/8"
LE-3631 12 21	12	1/2"
LE-3631 14 21	14	1/2"

Tech Sheet 1528

LF 3600® PUSH-IN FITTINGS



Male Stud Fittings



Elbow, Metric & BSPP

1014	OD mm	Thread
LE-3699 04 19	4	M5 x 0.8
LE-3699 04 52	4	M6 x 1
LE-3699 04 13	4	1/4"
LE-3699 04 56	4	M8 x 1
LE-3699 06 10	6	1/8"
LE-3699 06 60	6	M10 x 1
LE-3699 06 13	6	1/4"
LE-3699 08 10	8	1/8"
LE-3699 08 13	8	1/4"
LE-3699 08 17	8	3/8"
LE-3699 10 13	10	1/4"
LE-3699 10 17	10	3/8"
LE-3699 12 13	12	1/4"
LE-3699 12 17	12	3/8"
LE-3699 12 21	12	1/2"
LE-3699 14 17	14	3/8"

Tech Sheet 1528



Branch Tee, BSPT

1014	OD mm	Thread
LE-3608 06 10	6	1/8"
LE-3608 06 13	6	1/4"
LE-3608 08 13	8	1/4"
LE-3608 10 13	10	1/4"
LE-3608 12 17	12	3/8"
LE-3608 14 21	14	1/2"

Tech Sheet 1528



Run Tee, BSPT

1014	OD mm	Thread
LE-3603 06 10	6	1/8"
LE-3603 06 13	6	1/4"
LE-3603 08 13	8	1/4"
LE-3603 10 13	10	1/4"

Tech Sheet 1528



Branch Tee, BSPP

1014	OD mm	Thread
LE-3698 04 10	4	1/8"
LE-3698 06 13	6	1/4"
LE-3698 08 13	8	1/4"
LE-3698 14 21	14	1/2"

Tech Sheet 1528



Run Tee, BSPP

1014	OD mm	Thread
LE-3693 06 10	6	1/8"
LE-3693 08 13	8	1/4"

Tech Sheet 1528



Extended Stud Elbow, BSPT

1014	OD mm	Thread
LE-3629 04 10	4	1/8"
LE-3629 06 10	6	1/8"
LE-3629 06 13	6	1/4"
LE-3629 08 10	8	1/8"
LE-3629 08 13	8	1/4"

Tech Sheet 1528

Female Stud Fittings



Female Stud Hexagon, Metric & BSPP

1014	OD mm	Thread
LE-3614 04 10	4	1/8"
LE-3614 04 13	4	1/4"
LE-3614 06 10	6	1/8"
LE-3614 06 13	6	1/4"
LE-3614 08 10	8	1/8"
LE-3614 08 13	8	1/4"
LE-3614 10 17	10	3/8"
LE-3614 12 17	12	3/8"
LE-3614 12 21	12	1/2"

Tech Sheet 1528

Single Banjo c/w Bolt



Metric & BSPP

1014	OD mm	Thread
LE-3618 04 19	4	M5 x 0.8
LE-3618 04 10	4	1/8"
LE-3618 06 19	6	M5 x 0.8
LE-3618 06 10	6	1/8"
LE-3618 06 13	6	1/4"
LE-3618 08 10	8	1/8"
LE-3618 08 13	8	1/4"
LE-3618 10 17	10	3/8"

Tech Sheet 1528

Equal Connectors



Tube x Tube

1014	OD mm
LE-3606 04 00	4
LE-3606 06 00	6
LE-3606 08 00	8
LE-3606 10 00	10
LE-3606 12 00	12
LE-3606 14 00	14

Tech Sheet 1528

LF 3600® PUSH-IN FITTINGS

Equal Elbows



Tube x Tube

1014	OD mm
LE-3602 04 00	4
LE-3602 06 00	6
LE-3602 08 00	8
LE-3602 10 00	10
LE-3602 12 00	12
LE-3602 14 00	14

Tech Sheet 1528

Equal Tees



Tube x Tube

1014	OD mm
LE-3604 04 00	4
LE-3604 06 00	6
LE-3604 08 00	8
LE-3604 10 00	10
LE-3604 12 00	12
LE-3604 14 00	14

Tech Sheet 1528

Double Male Stem Connectors



Stem x Stem

1014	Stem OD mm
LE-3620 04 00	4
LE-3620 06 00	6
LE-3620 08 00	8
LE-3620 10 00	10
LE-3620 12 00	12

Tech Sheet 1528

Equal Bulkhead Elbows



Tube x Tube

1014	OD mm
LE-3639 04 00	4
LE-3639 06 00	6
LE-3639 08 00	8
LE-3639 10 00	10
LE-3639 12 00	12

Tech Sheet 1528

Bulkhead Connectors



Tube x Tube

1014	OD mm
LE-3616 04 00	4
LE-3616 06 00	6
LE-3616 08 00	8
LE-3616 10 00	10
LE-3616 12 00	12
LE-3616 14 00	14

Tech Sheet 1528



Female, BSPP

1014	OD mm	Thread
LE-3636 06 10	6	1/8"
LE-3636 06 13	6	1/4"
LE-3636 08 10	8	1/8"
LE-3636 08 13	8	1/4"
LE-3636 10 17	10	3/8"
LE-3636 12 21	12	1/2"

Tech Sheet 1528

Blanking Plugs



Tube

1014	Stem OD mm
LE-3626 04 00	4
LE-3626 06 00	6
LE-3626 08 00	8
LE-3626 10 00	10
LE-3626 12 00	12

Tech Sheet 1528

Plug-in Fittings



Reducer, Tube x Stem

1014	OD mm	Stem OD mm
LE-3666 04 06	4	6
LE-3666 04 08	4	8
LE-3666 06 08	6	8
LE-3666 06 10	6	10
LE-3666 08 10	8	10
LE-3666 08 12	8	12
LE-3666 10 12	10	12
LE-3666 12 14	12	14

Tech Sheet 1528



Increaser

1014	OD mm	Stem OD mm
LE-3668 06 04	6	4

Tech Sheet 1528



Metric/Imperial Adaptor, Tube x Stem

1014	OD	Stem OD mm
LE-3667 06 56	1/4"	6

Tech Sheet 1528



Stem x Hose Tail

1014	Stem OD	To Suit Hose ID mm
LE-3622 04 53	4	3.2
LE-3622 04 05	4	5
LE-3622 06 05	6	5
LE-3622 08 56	8	6.3
LE-3622 08 08	8	8
LE-3622 10 56	10	6.3
LE-3622 10 08	10	8
LE-3622 12 08	12	8
LE-3622 12 10	12	10
LE-3622 12 62	12	12.5

Tech Sheet 1528

CENTRALISED LUBRICATION SYSTEM FITTINGS



This range of fittings has been designed for uses involving both rotation or linear movements which require lubrication.

Designed using Legris push-in technology, this range is produced with specific applications in mind, hence its:

- Emphasis on safety – the tube cannot be disconnected without using a spanner
- Nitrile seals on nut assemblies
- Sealing of tube by 2 O-rings in addition to the gripping teeth

Working Temperature: -40°C to +120°C
Working Pressure: Up to 60 bar

The characteristics provide a perfect component for such applications as:

- Lubrication circuits on industrial machinery: Wood industry, textile, paper, cement industry
- Lubrication on industrial equipment and vehicles (trucks)
- Lubrication on public works vehicles (mobile cranes) and agricultural equipment

Suitable Fluids: Lubricating oils, liquid or viscous greases, oil sprays

Material:
Body: Brass
Seals: Nitrile rubber

Equal Connectors



Equal Straights

1012	OD mm
LE-6106 04 00	4
LE-6106 06 00	6
LE-6106 08 00	8



Equal Tees

1012	OD mm
LE-6104 04 00	4

Copper Washers



1012	OD mm
LE-0138 08 00	8
LE-0138 10 00	10
LE-0138 12 00	12

Close Tolerance Rigid Nylon



25 Metre Coils, Black

6001	OD mm	ID mm	Bend Radius mm
1025L04 01 25	4	2.5	35
1025L06 01	6	4	45
1025L08 01 05	8	5	70
1025L08 01	8	6	65

Stud Couplings



Male Studs, BSPT

1012	OD mm	Thread
LE-6105 04 10	4	1/8"
LE-6105 06 10	6	1/8"
LE-6105 04 13	4	1/4"
LE-6105 06 13	6	1/4"



Male Studs, Metric Taper

1012	OD mm	Thread
LE-6105 04 52	4	M6 x 1
LE-6105 04 56	4	M8 x 1
LE-6105 04 57	4	M8 x 1.25
LE-6105 04 60	4	M10 x 1
LE-6105 06 60	6	M10 x 1



Male Studs, Metric Parallel

1012	OD mm	Thread
LE-6101 06 60	6	M10 x 1
LE-6101 06 65	6	M12 x 1



Female Studs, Metric Parallel

1012	OD mm	Thread
LE-6114 04 56	4	M8 x 1
LE-6114 06 56	6	M8 x 1



Male Stud Elbows, BSPT

1012	OD mm	Thread
LE-6179 04 10	4	1/8"
LE-6179 06 10	6	1/8"
LE-6179 04 13	4	1/4"
LE-6179 06 13	6	1/4"



Male Stud Elbows, Metric

1012	OD mm	Thread
LE-6179 04 52	4	M6 x 1
LE-6179 04 56	4	M8 x 1
LE-6179 04 57	4	M8 x 1.25
LE-6179 04 60	4	M10 x 1
LE-6179 06 65	6	M12 x 1
LE-6179 08 65	8	M12 x 1

50000 SERIES - BRASS PUSH-IN FITTINGS



Working Temperature:
-20°C to +80°C

Maximum Working Pressure:
-0.99 to 20 bar (290 psi)

Media:
Suitable for compressed air and vacuum

Fittings with "Universal Short" thread are suitable for both taper as well as parallel threads like NPT, NPTF, BSPP and BSPT

Male Studs



Male Thread, Metric & BSPP

1020	OD mm	Thread
P2-3-M5	3	M5
P2-4-M5	4	M5
P2-4-1/8	4	1/8"
P2-4-1/4	4	1/4"
P2-5-M5	5	M5
P2-5-1/8	5	1/8"
P2-6-M5	6	M5
P2-6-1/8	6	1/8"
P2-6-1/4	6	1/4"
P2-6-3/8	6	3/8"
P2-6-1/2	6	1/2"
P2-8-1/8	8	1/8"
P2-8-1/4	8	1/4"
P2-8-3/8	8	3/8"
P2-8-1/2	8	1/2"
P2-10-1/4	10	1/4"
P2-10-3/8	10	3/8"
P2-10-1/2	10	1/2"
P2-12-1/4	12	1/4"
P2-12-3/8	12	3/8"
P2-12-1/2	12	1/2"
P2-14-3/8	14	3/8"
P2-14-1/2	14	1/2"

Tech Sheet 30106

Male Thread, BSPT (Universal Short)

1020	OD mm	Thread
P1-4-1/8	4	1/8"
P1-4-1/4	4	1/4"
P1-5-1/8	5	1/8"
P1-5-1/4	5	1/4"
P1-6-1/8	6	1/8"
P1-6-1/4	6	1/4"
P1-6-3/8	6	3/8"
P1-6-1/2	6	1/2"
P1-8-1/8	8	1/8"
P1-8-1/4	8	1/4"
P1-8-3/8	8	3/8"
P1-8-1/2	8	1/2"
P1-10-1/4	10	1/4"
P1-10-3/8	10	3/8"
P1-10-1/2	10	1/2"
P1-12-1/4	12	1/4"
P1-12-3/8	12	3/8"
P1-12-1/2	12	1/2"
P1-14-3/8	14	3/8"
P1-14-1/2	14	1/2"

Tech Sheet 30106

Universal, BSPT, BSPP & NPT (Round Body, Internal Hex)



1020	OD mm	Thread
P20-3-M5	3	M5
P20-4-M5	4	M5
P20-4-1/8	4	1/8"
P20-6-M5	6	M5
P20-6-1/8	6	1/8"
P20-6-1/4	6	1/4"
P20-8-1/8	8	1/8"
P20-8-1/4	8	1/4"

Tech Sheet 30106

Female Studs



Female Thread, Metric & BSPP

1020	OD mm	Thread
P3-3-M5	3	M5
P3-4-M5	4	M5
P3-4-1/8	4	1/8"
P3-4-1/4	4	1/4"
P3-5-1/8	5	1/8"
P3-6-1/8	6	1/8"
P3-6-1/4	6	1/4"
P3-8-1/8	8	1/8"
P3-8-1/4	8	1/4"
P3-8-3/8	8	3/8"
P3-10-1/4	10	1/4"
P3-10-3/8	10	3/8"
P3-10-1/2	10	1/2"
P3-12-3/8	12	3/8"
P3-12-1/2	12	1/2"

Tech Sheet 30106

Male Stud Elbows



Universal, BSPT, BSPP & NPT

1020	OD mm	Thread
P6-4-M5	4	M5
P6-4-1/8	4	1/8"
P6-5-1/8	5	1/8"
P6-6-1/8	6	1/8"
P6-6-1/4	6	1/4"
P6-8-1/8	8	1/8"
P6-8-1/4	8	1/4"
P6-10-1/4	10	1/4"
P6-10-3/8	10	3/8"
P6-12-1/4	12	1/4"
P6-12-3/8	12	3/8"

Tech Sheet 30106

Male Stud Swivel Elbows



Extended Male Thread, BSPP

1020	OD mm	Thread
P51-6-18	6	1/8"
P51-6-14	6	1/4"
P51-8-14	8	1/4"
P51-8-38	8	3/8"

Tech Sheet 30106

Extended Male, Universal, BSPT, BSPP & NPT

1020	OD mm	Thread
P50-4-18	4	1/8"
P50-6-18	6	1/8"
P50-6-14	6	1/4"
P50-8-18	8	1/8"
P50-8-14	8	1/4"
P50-10-38	10	3/8"

Tech Sheet 30106



50000 SERIES - BRASS PUSH-IN FITTINGS



Working Temperature:
-18°C to +70°C

Maximum Working Pressure:
20 bar (220 psi)

Media:
Suitable for compressed air and vacuum

Fittings with "Universal Short" thread are suitable for both taper as well as parallel threads like NPT, NPTF, BSPP and BSPT

Male Stud Swivel Elbows



Male Thread, Metric & BSPP

1020	OD	Thread
P8-3-M5	3	M5
P8-4-M5	4	M5
P8-4-1/8	4	1/8"
P8-4-1/4	4	1/4"
P8-5-M5	5	M5
P8-5-1/8	5	1/8"
P8-6-M5	6	M5
P8-6-1/8	6	1/8"
P8-6-1/4	6	1/4"
P8-6-3/8	6	3/8"
P8-8-1/8	8	1/8"
P8-8-1/4	8	1/4"
P8-8-3/8	8	3/8"
P8-8-1/2	8	1/2"
P8-10-1/4	10	1/4"
P8-10-3/8	10	3/8"
P8-10-1/2	10	1/2"
P8-12-1/4	12	1/4"
P8-12-3/8	12	3/8"
P8-12-1/2	12	1/2"
P8-14-3/8	14	3/8"
P8-14-1/2	14	1/2"

Tech Sheet 30106



Universal, BSPT, BSPP & NPT

1020	OD mm	Thread
P7-4-1/8	4	1/8"
P7-4-1/4	4	1/4"
P7-5-1/8	5	1/8"
P7-6-1/8	6	1/8"
P7-6-1/4	6	1/4"
P7-8-1/8	8	1/8"
P7-8-1/4	8	1/4"
P7-8-3/8	8	3/8"
P7-8-1/2	8	1/2"
P7-10-1/4	10	1/4"
P7-10-3/8	10	3/8"
P7-10-1/2	10	1/2"
P7-12-3/8	12	3/8"
P7-12-1/2	12	1/2"
P7-14-3/8	14	3/8"
P7-14-1/2	14	1/2"

Tech Sheet 30106

Female Stud Elbows



Female Thread, BSPP

1020	OD mm	Thread
P14-4-18	4	1/8"
P14-4-14	4	1/4"
P14-6-18	6	1/8"
P14-6-14	6	1/4"
P14-8-18	8	1/8"
P14-8-14	8	1/4"
P14-8-38	8	3/8"

Tech Sheet 30106

Male Stud Tees



Branch Male Thread, BSPT

1020	OD mm	Thread
P10-4-1/8	4	1/8"
P10-5-1/8	5	1/8"
P10-6-1/8	6	1/8"
P10-8-1/8	8	1/8"
P10-8-1/4	8	1/4"
P10-10-1/4	10	1/4"
P10-12-1/4	12	1/4"
P10-12-3/8	12	3/8"

Tech Sheet 30106

Male Stud Swivel Tees



Branch Male Thread, Metric & BSPP

1020	OD mm	Thread
P12-4-M5	4	M5
P12-4-1/8	4	1/8"
P12-5-M5	5	M5
P12-5-1/8	5	1/8"
P12-6-M5	6	M5
P12-6-1/8	6	1/8"
P12-6-1/4	6	1/4"
P12-8-1/8	8	1/8"
P12-8-1/4	8	1/4"
P12-8-3/8	8	3/8"
P12-8-1/2	8	1/2"
P12-10-1/4	10	1/4"
P12-10-3/8	10	3/8"
P12-10-1/2	10	1/2"
P12-12-3/8	12	3/8"
P12-12-1/2	12	1/2"
P12-14-3/8	14	3/8"
P12-14-1/2	14	1/2"

Tech Sheet 30106



Universal, BSPT, BSPP & NPT

1020	OD mm	Thread
P11-5-1/8	5	1/8"
P11-6-1/8	6	1/8"
P11-6-1/4	6	1/4"
P11-8-1/8	8	1/8"
P11-8-1/4	8	1/4"
P11-8-3/8	8	3/8"
P11-8-1/2	8	1/2"
P11-10-1/4	10	1/4"
P11-10-3/8	10	3/8"
P11-10-1/2	10	1/2"
P11-12-3/8	12	3/8"
P11-12-1/2	12	1/2"
P11-14-3/8	14	3/8"
P11-14-1/2	14	1/2"

Tech Sheet 30106

50000 SERIES - BRASS PUSH-IN FITTINGS

Working Temperature:
-18°C to +70°C

Maximum Working Pressure:
20 bar (220 psi)

Media:
Suitable for compressed air and vacuum

Fittings with "Universal Short" thread are suitable for both taper as well as parallel threads like NPT, NPTF, BSPP and BSPT

Male Stud Swivel Tees



Run Male Thread, Metric & BSPP

1020	OD mm	Thread
P45-4-M5	4	M5
P45-5-1/8	5	1/8"
P45-6-M5	6	M5
P45-6-1/8	6	1/8"
P45-6-1/4	6	1/4"
P45-8-1/8	8	1/8"
P45-8-1/4	8	1/4"

Tech Sheet 30106



Universal, BSPT, BSPP & NPT

1020	OD mm	Thread
P44-4-1/8	4	1/8"
P44-6-1/8	6	1/8"
P44-6-1/4	6	1/4"
P44-8-1/8	8	1/8"
P44-8-1/4	8	1/4"
P44-10-3/8	10	3/8"
P44-12-3/8	12	3/8"

Tech Sheet 30106

Straight Connectors



Equal Tube x Tube

1020	OD mm
P4-3	3
P4-4	4
P4-5	5
P4-6	6
P4-8	8
P4-10	10
P4-12	12
P4-14	14

Tech Sheet 30106

Unequal Tube x Tube

1020	OD mm
P4-6-4	6-4
P4-8-6	8-6

Tech Sheet 30106

Equal Elbows



Tube x Tube

1020	OD mm
P9-3	3
P9-4	4
P9-5	5
P9-6	6
P9-8	8
P9-10	10
P9-12	12
P9-14	14

Tech Sheet 30106

Equal Bulkhead Connectors



Tube x Tube

1020	OD mm	Thread
P5-3	3	M10 x 1
P5-4	4	M12 x 1
P5-5	5	M14 x 1
P5-6	6	M14 x 1
P5-8	8	M16 x 1
P5-10	10	M20 x 1
P5-12	12	M22 x 1

Tech Sheet 30106

Equal Tees



Tube x Tube

1020	OD mm
P16-3	3
P16-4	4
P16-5	5
P16-6	6
P16-8	8
P16-10	10
P16-12	12
P16-14	14

Tech Sheet 30106

Equal Ys



Tube x Tube

1020	OD mm
P21-3	3
P21-4	4
P21-5	5
P21-6	6
P21-8	8
P21-10	10

Tech Sheet 30106

Stem Adaptor



Metric & BSPP

1020	Stem OD mm	Thread
P30-4-M5	4	M5
P30-4-1/8	4	1/8"
P30-5-M5	5	M5
P30-5-1/8	5	1/8"
P30-5-1/4	5	1/4"
P30-6-M5	6	M5
P30-6-1/8	6	1/8"
P30-6-1/4	6	1/4"
P30-8-1/8	8	1/8"
P30-8-1/4	8	1/4"
P30-8-3/8	8	3/8"
P30-10-1/4	10	1/4"
P30-10-3/8	10	3/8"
P30-12-1/4	12	1/4"
P30-12-3/8	12	3/8"

Tech Sheet 30106

Reducers



Tube x Stem

1020	OD mm	Stem OD mm
P32-4-3	3	4
P32-5-4	4	5
P32-6-4	4	6
P32-6-5	5	6
P32-8-6	6	8
P32-10-8	8	10
P32-12-8	8	12
P32-12-10	10	12

Tech Sheet 30106

50000 SERIES, BRASS PUSH-IN FITTINGS



Working Temperature:
-18°C to +70°C

Maximum Working Pressure:
20 bar (220 psi)

Media:
Suitable for compressed air and vacuum

Single Banjo Body, 1 Outlet



Bolt Thread, Metric & BSPP

1020	OD mm	Thread
P17-4-M5	4	M5
P17-4-1/8	4	1/8"
P17-6-M5	6	M5
P17-6-1/8	6	1/8"
P17-6-1/4	6	1/4"
P17-8-1/8	8	1/8"
P17-8-1/4	8	1/4"
P17-8-3/8	8	3/8"
P17-10-1/4	10	1/4"
P17-12-3/8	12	3/8"

Tech Sheet 30106

5 Way Manifolds



BSPP

1020	OD mm	Thread
P39-4-1/8	4	1/8"
P39-6-1/8	6	1/8"
P39-6-1/4	6	1/4"
P39-8-1/4	8	1/4"

Tech Sheet 30106

Disassembling Tool



1020
P43

Tech Sheet 30106

Single Banjo Assembly, 1 Outlet



Bolt Thread, Metric & BSPP

1020	OD mm	Thread
P22-4-M5	4	M5
P22-4-1/8	4	1/8"
P22-5-M5	5	M5
P22-5-1/8	5	1/8"
P22-6-M5	6	M5
P22-6-1/8	6	1/8"
P22-6-1/4	6	1/4"
P22-8-1/8	8	1/8"
P22-8-1/4	8	1/4"
P22-8-3/8	8	3/8"
P22-10-1/4	10	1/4"
P22-10-3/8	10	3/8"
P22-12-3/8	12	3/8"

Tech Sheet 30106

Double Banjo Assembly, 2 Outlets



Bolt Thread, BSPP

1020	OD mm	Thread
P23-4-1/8	4	1/8"
P23-6-1/8	6	1/8"
P23-6-1/4	6	1/4"
P23-8-1/8	8	1/8"
P23-8-1/4	8	1/4"
P23-8-3/8	8	3/8"
P23-10-1/4	10	1/4"
P23-12-3/8	12	3/8"

Tech Sheet 30106

Triple Banjo Assembly, 3 Outlets



Bolt Thread, BSPP

1020	OD mm	Thread
P24-6-1/8	6	1/8"
P24-6-1/4	6	1/4"
P24-8-1/4	8	1/4"

Tech Sheet 30106

Double Banjo Tee Assembly, 4 Outlets



Bolt Thread, BSPP

1020	OD mm	Thread
P26-6-1/4	6	1/4"
P26-8-1/4	8	1/4"

Tech Sheet 30106

Double Banjo Tee Assembly, 6 Outlets



Bolt Thread, BSPP

1020	OD mm	Thread
P27-8-1/4	8	1/4"

Tech Sheet 30106

Swivel Single Banjo Assembly, 1 Outlet



Bolt Thread, Metric & BSPP

1020	OD mm	Thread
P28-4-M5	4	M5
P28-4-1/8	4	1/8"
P28-5-M5	5	M5
P28-5-1/8	5	1/8"
P28-5-1/4	5	1/4"
P28-6-M5	6	M5
P28-6-1/8	6	1/8"
P28-6-1/4	6	1/4"
P28-8-1/8	8	1/8"
P28-8-1/4	8	1/4"
P28-10-1/4	10	1/4"

Tech Sheet 30106

Swivel Double Banjo Tee Assembly, 2 Outlets



Bolt Thread, BSPP

1020	OD mm	Thread
P29-4-1/8	4	1/8"
P29-6-1/8	6	1/8"

Tech Sheet 30106

50000 SERIES BRASS PUSH-IN FITTINGS



Working Temperature:
-20°C to +80°C

Maximum Working Pressure:
20 bar
Vacuum: -0.99 bar

Material:
Body and Collet: Robust nickel plated
brass body and Acetalic resin collet

O-Ring: Nitrile
Media: Compressed air

Fittings with "Universal Short" thread are
suitable for both taper as well as parallel
threads like NPT, NPTF, BSPP and BSPT

Elbows



Equal

1025	OD mm
50130N4	4
50130N6	6
50130N8	8
50130N10	10
50130N12	12
50130N14	14

Male Swivel Elbows



Universal, BSPT, BSPP & NPT

1025	OD mm	Thread
50111N4-1/8	4	1/8"
50111N4-1/4	4	1/4"
50111N6-1/8	6	1/8"
50111N6-1/4	6	1/4"
50111N8-1/8	8	1/8"
50111N8-1/4	8	1/4"
50111N8-3/8	8	3/8"
50111N8-1/2	8	1/2"
50111N10-1/4	10	1/4"
50111N10-3/8	10	3/8"
50111N10-1/2	10	1/2"
50111N12-3/8	12	3/8"
50111N12-1/2	12	1/2"
50111N14-3/8	14	3/8"
50111N14-1/2	14	1/2"

Female Swivel Elbows



BSPP

1025	OD mm	Thread
50106N4-1/8	4	1/8"
50106N4-1/4	4	1/4"
50106N6-1/8	6	1/8"
50106N6-1/4	6	1/4"
50106N8-1/8	8	1/8"
50106N8-1/4	8	1/4"
50106N8-3/8	8	3/8"

Tees



Equal

1025	OD mm
50230N4	4
50230N6	6
50230N8	8
50230N10	10
50230N12	12
50230N14	14

Male Swivel Tees



Universal, BSPT, BSPP & NPT

1025	OD mm	Thread
50211N4-1/8	4	1/8"
50211N4-1/4	4	1/4"
50211N6-1/8	6	1/8"
50211N6-1/4	6	1/4"
50211N8-1/8	8	1/8"
50211N8-1/4	8	1/4"
50211N8-3/8	8	3/8"
50211N8-1/2	8	1/2"
50211N10-1/4	10	1/4"
50211N10-3/8	10	3/8"
50211N10-1/2	10	1/2"
50211N12-3/8	12	3/8"
50211N12-1/2	12	1/2"
50211N14-3/8	14	3/8"
50211N14-1/2	14	1/2"

Male Swivel Offset Tees



Universal, BSPT, BSPP & NPT

1025	OD mm	Thread
50223N4-1/8	4	1/8"
50223N4-1/4	4	1/4"
50223N6-1/8	6	1/8"
50223N6-1/4	6	1/4"
50223N8-1/8	8	1/8"
50223N8-1/4	8	1/4"
50223N8-3/8	8	3/8"
50223N8-1/2	8	1/2"
50223N10-1/4	10	1/4"
50223N10-3/8	10	3/8"
50223N10-1/2	10	1/2"
50223N12-3/8	12	3/8"
50223N12-1/2	12	1/2"

Male Swivel Banjo



BSPP & Metric

1025	OD mm	Thread
50550N4-M5	4	M5
50550N4-1/8	4	1/8"
50550N6-M5	6	M5
50550N6-1/8	6	1/8"
50550N6-1/4	6	1/4"
50550N8-1/8	8	1/8"
50550N8-1/4	8	1/4"
50550N8-3/8	8	3/8"
50550N10-1/4	10	1/4"
50550N10-3/8	10	3/8"
50550N12-3/8	12	3/8"

Y Connectors



Equal

1025	OD mm
50310N4	4
50310N6	6
50310N8	8
50310N10	10

Straight Connector



Equal

1025	OD mm
50040N4	4
50040N6	6
50040N8	8
50040N10	10
50040N12	12

Unequal

1025	OD mm	OD mm
50040N6-4	4	6
50040N8-6	6	8
50040N10-8	8	10
50040N12-10	10	12

Reducer



Tube x Stem Reducers

1025	OD mm	OD mm
50700N6-4	6	4
50700N8-4	8	4
50700N8-6	8	6
50700N10-4	10	4
50700N10-6	10	6
50700N10-8	10	8
50700N12-8	12	8
50700N12-10	12	10

55000 SERIES METAL BODY PUSH-IN FITTINGS



Working Temperature:
-20°C to +80°C

Maximum Working Pressure:
20 bar

Vacuum: -0.99 bar

BSPT in conformity with ISO 7.1, BS 21, DIN 2999.

BSPP in conformity with ISO 228 Class A.

Metric in conformity with ISO R/262.

Fittings with "Universal Short" thread are suitable for both taper as well as parallel threads like NPT, NPTF, BSPP and BSPT.

Straight Male Adaptors

This is a Taper Thread designed so that its suitable for BSPT, BSPP, NPTF and Metric.



Universal, BSPT, BSPP & NPT

1020	OD mm	Thread
5500000001	4	1/8"
5500000013	4	1/4"
5500000002	5	1/8"
5500000003	5	1/4"
5500000004	6	1/8"
5500000005	6	1/4"
5500000014	6	3/8"
5500000015	6	1/2"
5500000006	8	1/8"
5500000007	8	1/4"
5500000008	8	3/8"
5500000016	8	1/2"
5500000009	10	1/4"
5500000010	10	3/8"
5500000017	10	1/2"
5500000011	12	1/4"
5500000012	12	3/8"
5500000018	12	1/2"
5500000019	14	3/8"
5500000020	14	1/2"

Tech Sheet 10709



Universal, BSPT, BSPP & NPT

1020	OD mm	Thread
5501000001	4	1/8"
5501000002	6	1/8"
5501000003	6	1/4"
5501000004	8	1/8"
5501000005	8	1/4"

Tech Sheet 10709

(Hex Body) Metric & BSPP

1020	OD mm	Thread
5002000N01	4	M5
5002000N02	4	1/8"
5002000N22	4	1/4"
5002000N18	5	M5
5002000N19	5	1/8"
5002000N20	6	M5
5002000N12	6	M12 x 1
5002000N13	6	M12 x 1.25
5002000N14	6	M12 x 1.5
5002000N03	6	1/8"
5002000N04	6	1/4"
5002000N27	6	3/8"
5002000N28	6	1/2"
5002000N17	8	M12 x 1.5
5002000N05	8	1/8"
5002000N06	8	1/4"
5002000N07	8	3/8"
5002000N29	8	1/2"
5002000N08	10	1/4"
5002000N09	10	3/8"
5002000N31	10	1/2"
5002000N32	12	1/4"
5002000N11	12	3/8"
5002000N23	12	1/2"
5002000N24	14	3/8"
5002000N25	14	1/2"

Tech Sheet 10709

Straight Female Adaptors



(Hex Body) Metric & BSPT

1020	OD mm	Thread
5003000N08	4	M5
5003000N01	4	1/8"
5003000N09	4	1/4"
5003000N06	5	1/8"
5003000N02	6	1/8"
5003000N03	6	1/4"
5003000N04	8	1/8"
5003000N05	8	1/4"
5003000N10	8	3/8"
5003000N11	10	1/4"
5003000N12	10	3/8"
5003000N13	10	1/2"
5003000N14	12	3/8"
5003000N15	12	1/2"

Tech Sheet 10709

Bulkhead Connectors



Tube x Tube

1020	OD mm	Thread Size:
5005000N01	4	M12X1
5005000N06	5	M14X1
5005000N02	6	M14X1
5005000N03	8	M16X1
5005000N04	10	M20X1
5005000N05	12	M22X1

Tech Sheet 10709

58000 SERIES HIGH PRESSURE LUBRICATION FITTINGS



Working Temperature:
-30°C to +150°C



Maximum Working Pressure:
150 bar



Maximum Working Pressure for compressed air:
30 bar



Maximum Working Pressure for fluids:
150 bar

- Nickel plated brass collet and body
- Compressed air, oil and grease
- PA6, PA11, PA12 polyethylene, polyurethane (polyurethane hoses require a minimum hardness of 98 shore)

Male Adaptors



Metric & BSPT

1020	OD mm	Thread
58000-4-M6	4	M6 x 1
58000-4-M8	4	M8 x 1
58000-4-M10	4	M10 x 1
58000-4-1/8	4	1/8"
58000-6-M6	6	M6 x 1
58000-6-M8	6	M8 x 1
58000-6-M10	6	M10 x 1
58000-6-1/8	6	1/8"

Elbow Adaptors



Metric & BSPP

1020	OD mm	Thread
58100-4-M6	4	M6 x 1
58100-4-M8	4	M8 x 1
58100-4-M10	4	M10 x 1
58100-4-1/8	4	1/8"
58100-6-M6X1	6	M6 x 1
58100-6-M8X1	6	M8 x 1
58100-6-M10X1	6	M10 x 1
58100-6-1/8	6	1/8"

Swivel Elbow Adaptors



Metric & BSPT

1020	OD mm	Thread
58110-4-M6	4	M6 x 1
58110-4-M8	4	M8 x 1
58110-4-M10	4	M10 x 1
58110-4-1/8	4	1/8"
58110-6-M6	6	M6 x 1
58110-6-M8	6	M8 x 1
58110-6-M10	6	M10 x 1
58110-6-1/8	6	1/8"

Straight Connectors



Tube x Tube

1020	OD mm	OD mm
58040-4	4	4
58040-6	6	6

89000 SERIES IMPERIAL TUBE FITTINGS



Working Temperature:
-20°c to +80°C

Working Pressure:
-0.99 bar to 20 bar

Fittings with “Short” tapered thread allow assembly with tapered as well as parallel threads (BSPT, NPT and BSPP) and have a reduced overall height. The clamping washer made in stainless steel ensures the perfect grip on the tube with all kinds of material without damage to the surface.

The connection between the tube and the fitting ensure a tight seal even in severe conditions such as impact and vibration. The design of the geometric seal ensures the perfect fit for vacuum applications Suitable to be used with PA6, PA11, PA12, Polyethylene, Polyurethane (minimum hardness of 98 shore).

Material:
Body: Brass nickel plated
Collet: Brass nickel plated
Capsule: Brass nickel plated
Clamping Washer: Stainless steel 301
Media: Compressed air, vacuum, water

Straight Male Adaptors

This is a taper thread designed so that its suitable for BSPT, BSPP, NPTF and metric.



Universal Short Thread Type

1020	OD	Thread
8900000001	1/8"	1/8"
8900000002	1/8"	1/4"
8900000003	5/32"	1/8"
8900000004	5/32"	1/4"
8900000005	1/4"	1/8"
8900000006	1/4"	1/4"
8900000007	1/4"	3/8"
8900000008	5/16"	1/8"
8900000009	5/16"	1/4"
8900000010	5/16"	3/8"
8900000011	3/8"	1/8"
8900000012	3/8"	1/4"
8900000013	3/8"	3/8"
8900000014	3/8"	1/2"
8900000015	1/2"	1/8"
8900000016	1/2"	1/4"
8900000017	1/2"	3/8"
8900000018	1/2"	1/2"

Tech Sheet 10707

Straight Female Adaptors



NPT

1020	OD	Thread
8903000001	1/8"	1/8"
8903000002	1/8"	1/4"
8903000003	5/32"	1/8"
8903000004	5/32"	1/4"
8903000005	1/4"	1/8"
8903000006	1/4"	1/4"
8903000007	3/8"	1/4"
8903000008	3/8"	3/8"

Tech Sheet 10707

Swivel Male Elbows

This is a taper thread designed so that its suitable for BSPT, BSPP, NPTF and metric.



Universal Short Thread Type

1020	OD	Thread
8911100001	1/8"	1/8"
8911100002	1/8"	1/4"
8911100003	5/32"	1/8"
8911100004	5/32"	1/4"
8911100005	1/4"	1/8"
8911100006	1/4"	1/4"
8911100007	1/4"	3/8"
8911100008	5/16"	1/8"
8911100009	5/16"	1/4"
8911100011	3/8"	1/8"
8911100012	3/8"	1/4"
8911100013	3/8"	3/8"
8911100014	3/8"	1/2"
8911100015	1/2"	1/4"
8911100016	1/2"	3/8"
8911100017	1/2"	1/2"

Tech Sheet 10707

Swivel Female Elbows



NPT

1020	OD	Thread
8910600001	5/32"	1/8"
8910600002	1/4"	1/4"
8910600003	5/32"	1/8"
8910600004	1/4"	1/4"
8910600005	3/8"	1/8"
8910600006	3/8"	1/4"

Tech Sheet 10707

Swivel Tee Male Centre Leg

This is a taper thread designed so that its suitable for BSPT, BSPP, NPTF and metric.



Universal Short Thread Type

1020	OD	Thread
8921100001	1/8"	1/8"
8921100005	1/4"	1/8"
8921100006	1/4"	1/4"
8921100007	1/4"	3/8"
8921100014	3/8"	1/8"
8921100008	3/8"	1/4"
8921100009	3/8"	3/8"
8921100010	3/8"	1/2"
8921100011	1/2"	1/4"
8921100012	1/2"	3/8"
8921100013	1/2"	1/2"

Tech Sheet 10707



For PRO3
see page 420

89000 SERIES IMPERIAL TUBE FITTINGS



 **Working Temperature:**
-20°C to +80°C

 **Working Pressure:**
-0.99 bar to 20 bar

The clamping washer made in stainless steel ensures the perfect grip on the tube with all kinds of material without damage to the surface.

The connection between the tube and the fitting ensure a tight seal even in severe conditions such as impact and vibration.

The design of the geometric seal ensures the perfect fit for vacuum applications.

Suitable to be used with PA6, PA11, PA12, polyethylene, polyurethane (minimum hardness of 98 shore).

Material:

Body: Brass nickel plated

Collet: Brass nickel plated

Capsule: Brass nickel plated

Clamping Washer: Stainless steel 301

Media: Compressed air, vacuum, water

Straight Male Adaptors



Tube x Tube

1020	OD
8904000001	1/8"
8904000002	5/32"
8904000004	1/4"
8904000005	5/16"
8904000007	3/8"
8904000008	1/2"

Tech Sheet 10707

Equal Elbows



Tube x Tube

1020	OD
8913000001	1/8"
8913000002	5/32"
8913000003	1/4"
8913000004	5/16"
8913000005	3/8"
8913000006	1/2"

Tech Sheet 10707

Equal Bulkheads



Tube x Tube

1020	OD
8905000001	1/8"
8905000003	1/4"
8905000004	5/16"
8905000005	3/8"
8905000006	1/2"

Tech Sheet 10707

Unequal Straight Male Adaptors



Tube x Tube

1020	OD	OD
8904000003	1/4"	5/32"
8904000006	3/8"	1/4"
8904000009	3/8"	1/2"

Tech Sheet 10707

Equal Tees



Tube x Tube

1020	OD
8923000001	1/8"
8923000003	1/4"
8923000004	5/16"
8923000005	3/8"
8923000006	1/2"

Tech Sheet 10707

Stem Reducers



Tube x Tube

1020	Stem OD	OD
8970000001	1/4"	1/8"
8970000002	1/4"	5/32"
8970000003	3/8"	1/4"
8970000004	1/2"	1/4"
8970000005	1/2"	3/8"

Tech Sheet 10707



For **Stainless Steel Mini Cylinders**
see page **457**

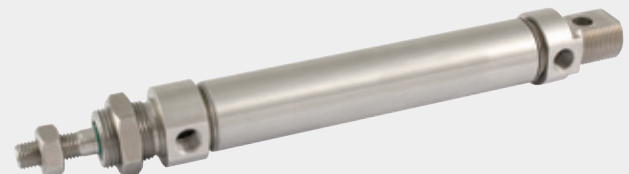

FOOD GRADE PUSH-IN FITTINGS



Working Temperature:
-15°C to +190°C

Working Pressure:
-0.99 to 20 bar



Brass nickel plated fittings designed for the food industry.
Suitable for compressed air, vacuum and water.

Straight Adaptors



Male Thread, Metric & BSPP

1020	OD mm	Thread
70020-4-M5	4	M5
70020-4-1/8	4	1/8"
70020-6-1/8	6	1/8"
70020-6-1/4	6	1/4"
70020-8-1/8	8	1/8"
70020-8-1/4	8	1/4"
70020-10-1/4	10	1/4"
70020-10-3/8	10	3/8"
70020-12-3/8	12	3/8"

Tech Sheet 1905

Swivel Elbows



Male Thread, Metric & BSPP

1020	OD mm	Thread
70116-4-M5	4	M5
70116-4-1/8	4	1/8"
70116-6-1/8	6	1/8"
70116-6-1/4	6	1/4"
70116-8-1/8	8	1/8"
70116-8-1/4	8	1/4"
70116-10-1/4	10	1/4"
70116-10-3/8	10	3/8"
70116-12-3/8	12	3/8"

Tech Sheet 1905

Tee Connectors



Tube x Tube

1020	OD mm
70230-4	4
70230-6	6
70230-8	8
70230-10	10
70230-12	12

Tech Sheet 1905

Straight Connectors



Tube x Tube

1020	OD mm
70040-4	4
70040-6	6
70040-8	8
70040-10	10
70040-12	12

Tech Sheet 1905

Swivel Tees



Male Thread, BSPT

1020	OD mm	Thread
70216-4-1/8	4	1/8"
70216-6-1/8	6	1/8"
70216-6-1/4	6	1/4"
70216-8-1/8	8	1/8"
70216-8-1/4	8	1/4"

Tech Sheet 1905



For ISO 15552 Cylinders
see pages 478-486



PNEUFIT® PUSH-IN FITTINGS, METRIC



- Very compact units featuring retained collets and positive tube anchorage
- Silicone free O-ring seals
- Non-PTFE based thread sealant on all BSP taper threads
- Easy tube insertion for rapid assembly
- Positive tube anchorage
- For simple and quick assembly of pneumatic circuits
- Wide range of types available
- Reliable and corrosion resistant

Fluid: Compressed air

Body: Nickel plated brass

Washer (Banjo): PA

Collet: Nickel plated brass

Thread Sealant: Non-PTFE

O-Ring: VMQ free NBR

Tube Sizes:

Warning: The push-in tube fittings in this section must not be used in vehicle air braking and ancillary systems

Tube Types: Positive tube anchorage

Warning: PA 11 or 12, PUR and other plasticised or unplasticised tubing which conforms to the tolerances specified in BS 5409, Part 1, 1976, light and normal dut , DIN 73378, DIN 74234, NFE 49-100

Working Temperature:
-20°C to +80°C

Maximum Working Pressure:
Vacuum – 18 bar unless otherwise stated
(dependant upon tubing specification)

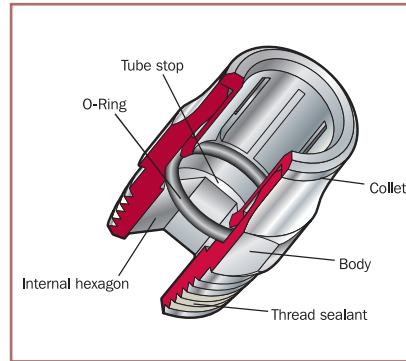

Straight Stem Adaptors



BSPP

0038	OD mm	Thread
102150418	4	1/8"
102150618	6	1/8"
102150838	8	3/8"
102151028	10	1/4"
102151038	10	3/8"
102151248	12	3/8"

Straight Adaptors



BSPP & Metric

0038	OD mm	Thread
102250405	4	M5
102250418	4	1/8"
102250428	4	1/4"
102250605	6	M5
102250618	6	1/8"
102250628	6	1/4"
102250818	8	1/8"
102250828	8	1/4"
102250838	8	3/8"
102251018	10	1/8"
102251028	10	1/4"
102251038	10	3/8"
102251228	12	1/4"
102251238	12	3/8"



BSPT

0038	OD mm	Thread
101150418	4	1/8"
101150618	6	1/8"
101150628	6	1/4"
101150818	8	1/8"
101150828	8	1/4"
101151028	10	1/4"
101151038	10	3/8"
101151238	12	3/8"

Swivel Elbows



BSPT

0038	OD mm	Thread
101470418	4	1/8"
101470428	4	1/4"
101470618	6	1/8"
101470628	6	1/4"
101470638	6	3/8"
101470818	8	1/8"
101470828	8	1/4"
101470838	8	3/8"
101471018	10	1/8"
101471028	10	1/4"
101471038	10	3/8"
101471228	12	1/4"
101471238	12	3/8"

Elbow Connectors



Tube x Tube

0038	OD mm
100400400	4
100400600	6
100400800	8
100401000	10
100401200	12

Straight Connectors



Tube x Tube

0038	OD mm
100200400	4
100200600	6
100200800	8
100201000	10
100201200	12

Bulkhead Connectors



Tube x Tube

0038	OD mm
100290400	4
100290600	6
100290800	8
100291000	10
100291200	12

Tee Connectors



Tube x Tube

0038	OD mm
100600400	4
100600600	6
100600800	8
100601000	10
100601200	12

PNEUFIT® PUSH-IN FITTINGS, IMPERIAL



- For simple and quick assembly of pneumatic circuits
- Positive tube anchorage
- Wide range of types available
- Reliable and corrosion resistant

Medium: Compressed air

Collet and Body Manufactured from Bar:
Nickel plated brass to BS 2874: 1986 (CZ121)

Body Manufactured from Stamping:
Nickel plated brass to BS 2872: 1969 (CZ122)

Seal: Nitrile rubber

Tube Sizes: 1/8", 1/4", 3/8", 1/2" O/D

Warning:
The push-in tube fittings in this section must not be used in vehicle air braking and ancillary systems

Working Temperature:
-20°C to +80°C

Maximum Working Pressure:
Vacuum – 18 bar unless otherwise stated
(dependant upon tubing specification)

Straight Adaptors



BSPT

0038	OD	Thread
121250118	1/8"	1/8"
121250418	1/4"	1/8"
121250428	1/4"	1/4"
121250628	3/8"	1/4"
121250638	3/8"	3/8"

Straight Connectors



Tube x Tube

0038	OD
120200400	1/4"
120200600	3/8"

Bulkhead Connectors



Tube x Tube

0038	OD	Thread
120290400	1/4"	M12 x 1.0
120290600	3/8"	M20 x 1.5

Elbow Connectors



Tube x Tube

0038	OD
120400400	1/4"
120400600	3/8"

90° Swivel Elbow Adaptors



BSPT

0038	OD	Thread
121470418	1/4"	1/8"
121470428	1/4"	1/4"
121470628	3/8"	1/4"
121470638	3/8"	3/8"

Swivel Tee Adaptor



BSPT

0038	OD	Thread
121670418	1/4"	1/8"

Tee Connectors



Tube x Tube

0038	OD
120600300	3/16"
120600400	1/4"
120600600	3/8"



For Olympian Plus Boxed Sets
see page 683



NON-RETURN VALVES & FITTINGS



Non-return Valves

- Allow free flow in one direction only
- Simple reliable design
- Low weight
- Low cracking pressure
- High operating pressure

Medium:

Compressed air, filtered, lubricated and non-lubricated, vacuum

Body:

Anodised aluminium

Collet:

Nickel plated brass

Spring:

Stainless steel

Seals:

Nitrile rubber

Valve and Insert:

Aluminium

Mounting:

Line mounted, push-in connection

Tubing Types:

Nylon 11 or 12. Polyurethane, and other plasticised or unplasticised tubing which conforms to the tolerances specified in BS 5409, part 1, 1976, light and normal duty, DIN 73378, DIN 74234, NFE 49100



Working Pressure:

-0.9 to 16 bar (dependent upon operating specification of tubing)

Working Temperature: -20°C to +80°C



T50 Series, In-line Push-in

0038	OD mm	Cracking Pressure Bar
T50P0004	4	0.03
T50P0006	6	0.03
T50P0008	8	0.03
T50P0010	10	0.03
T50P0012	12	0.03

Tech Sheet 20749

Blocking, Pressure Reducing & Pneumatic Sensor Fittings

- Very compact units
- Safer pneumatic systems
- Easy tube insertion for rapid assembly of pneumatic circuits
- BSP threads



Working Temperature: 0°C to +70°C



Operating Pressures:

Blocking Fitting:

Supply pressure: 1-10 bar

Pressure Reducing Fitting:

Primary pressure: 1-16 bar max.

Secondary pressure: 1-8 bar max.

Pressure Sensor Fitting:

Cylinder pressure (Pc): 10 bar max.

Sensor supply pressure: 3-10 bar

Tubing Types:

Nylon 11 or 12, polyurethane and other plasticised or unplasticised tubing which conforms to the tolerances specified in BS 5409, Part 1, 1976, light and normal duty, DIN 73378, DIN 74234, NFE 49-100

Cover (pilot thread): Brass

Lock rings: SUS

Main body: Brass

Case (female thread): Zinc die-casting

Valve: SUS and NBR

Springs: SUS

Sealing: NBR



Blocking Fitting, BSPP

0038	OD	Thread
102GA1818	1/8"	1/8"
102GA2828	1/4"	1/4"
102GA3838	3/8"	3/8"
102GA4848	1/2"	1/2"

Tech Sheet 71731

Banjo body: Aluminium

Retaining ring: PA

Banjo bolt and valve: Brass - zinc plated

Washer: NBR



Pressure Reducing Fitting, BSPP

0038	OD	Thread
102GB1818	1/8"	1/8"
102GB2828	1/4"	1/4"
102GB3838	3/8"	3/8"
102GB4848	1/2"	1/2"

Tech Sheet 71732

Body: PA

Banjo bolt: nickel plated brass

Washer: NBR and PU



Pneumatic Sensor Fitting, BSPP

0038	OD	Thread
102GD0418	4	1/8"
102GD0428	4	1/4"

Tech Sheet 71733



For Norgren Excelon Plus
see pages 686-688

FOOD GRADE FITTINGS

Series F Push-in Fittings, Safe for Use in the Food Industry

Brass parts are chemically treated with phosphorus nickel-plating according to the NSF®/ANSI 51 standard of the food programme. The seals are made of FDA-approved FKM/FPM. Fittings contain no technopolymer, solving the problem of incompatibility with detergents and other chemicals.

The fittings can be used up to +150°C, making them suitable for high temperature applications other industries. The threads are cylindrical and under-head o-rings provide a pneumatic seal. This avoids the need for sealants (e.g. Teflon®) which could release solid fragments during screwing and unscrewing that would contaminate the environment or the fluid. Our fittings can be screwed and unscrewed any number of times and still remain clean and pneumatically sealed.

This choice of materials and treatments make these fittings suitable for use in the chemical, pharmaceutical, medical and electronics industry.

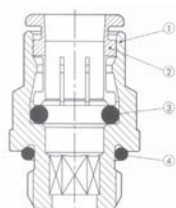

1. Body: chemically nickel plated brass to NSF®/ANSI 51 standards
2. Gripper: chemically nickel plated brass to NSF®/ANSI 51 standards
3. Fitting seal: FKM/FPM
4. Port seal: FKM/FPM

Temperature Range:
-20°C to +150°C (-4°F to 302°F)

Pressure:
-0.99 to 16 bar (-0.099 to 1.6 MPa)

Technical Features

- Threaded ports: M5, G1/8", G1/4", G3/8", G1/2"
- Pipe diameter: 4, 6, 8 and 10mm
- Recommended pipe: Rilsan PA 11, nylon 6, polyamide 12, polypropylene
- Under-head O-ring can be screwed and unscrewed any number of times; no fragments of Teflon® or sealant will contaminate the fluid
- Corrosion proof: chemical nickel-plating + FKM/FPM, compatible with numerous substances
- No plastic parts, so no risk of incompatibility

Male Stud



BSP Parallel x Tube

9186	Tube OD mm	Thread BSPP
2F01001	4	M5
2F01002	4	G1/8"
2F01003	4	G1/4"
2F01000	6	M5
2F01007	6	G1/8"
2F01008	6	G1/4"
2F01009	8	G1/8"
2F01010	8	G1/4"
2F01011	8	G3/8"
2F01012	10	G1/4"
2F01013	10	G3/8"
2F01022	10	G1/2"

Male Stud



BSP Tapered x Tube

9186	Tube OD mm	Thread BSPT
2F01C02	4	R1/8"
2F01C07	6	R1/8"
2F01C08	6	R1/4"
2F01C09	8	R1/8"
2F01C10	8	R1/4"
2F01C11	8	R3/8"
2F01C13	10	R1/4"
2F01C14	10	R3/8"

Straight Connector



Tube x Tube

9186	Tube OD mm	Bulkhead Thread
2F03001	4	M13 x 1
2F03003	6	M15 x 1
2F03004	8	M17 x 1
2F03005	10	M20 x 1

Equal Tee



Tube x Tube

9186	Tube OD mm
2F05001	4
2F05003	6
2F05004	8
2F05005	10

FOOD GRADE FITTINGS

Male Stud Swivel Elbow



BSP Parallel x Tube

9186	Thread BSPP	Tube OD mm
2F31001	M5	4
2F31002	G1/8"	4
2F31003	G1/4"	4
2F31007	M5	6
2F31008	G1/8"	6
2F31009	G1/4"	6
2F31010	G1/8"	8
2F31011	G1/4"	8
2F31012	G3/8"	8
2F31013	G1/4"	10
2F31014	G3/8"	10
2F31015	G1/2"	10

Bulkhead Connector



Tube x Tube

9186	Tube OD mm	Bulkhead Thread
2F11001	4	M13 x 1
2F11003	6	M15 x 1
2F11004	8	M17 x 1
2F11005	10	M20 x 1

Equal Elbow



Tube x Tube

9186	Tube OD mm
2F04001	4
2F04003	6
2F04004	8
2F04005	10

Male Stud Swivel Elbow



BSP Parallel x Tube

9186	Thread BSPT	Tube OD mm
2F31C02	R1/8"	4
2F31C03	R1/4"	4
2F31C08	R1/8"	6
2F31C09	R1/4"	6
2F31C10	R1/8"	8
2F31C11	R1/4"	8
2F31C12	R3/8"	8
2F31C13	R1/4"	10
2F31C14	R3/8"	10

Male Stem Adaptor



BSP Parallel x Tube

9186	Thread BSPP	Tube OD mm
2F06001	M5	4
2F06002	G1/8"	4
2F06003	G1/4"	4
2F06000	M5	6
2F06007	G1/8"	6
2F06008	G1/4"	6
2F06009	G1/8"	8
2F06010	G1/4"	8
2F06011	G3/8"	8
2F06012	G1/4"	10
2F06013	G1/4"	10

Male Stud Elbow



BSP Parallel x Tube

9186	Thread BSPT	Tube OD mm
2F39C02	R1/8"	4
2F39C08	R1/8"	6
2F39C09	R1/4"	6
2F39C10	R1/8"	8
2F39C11	R1/4"	8
2F39C12	R3/8"	8
2F39C13	R1/4"	10

Male Swivel Branch Tee



BSP Parallel x Tube

9186	Thread BSPP	Tube OD mm
2F32002	G1/8"	4
2F32008	G1/8"	6
2F32009	G1/4"	6
2F32010	G1/8"	8
2F32011	G1/4"	8
2F32012	G3/8"	8
2F32013	G1/4"	10
2F32014	G3/8"	10

Female Stud



BSP Parallel x Tube

9186	Thread BSPP	Tube OD mm
2F02001	G1/8"	4
2F02005	G1/8"	6
2F02006	G1/4"	6
2F02007	G1/8"	8
2F02008	G1/4"	8
2F02011	G1/4"	10

NICKEL PLATED BRASS & TECHNOPOLYMER

Push-in fittings by Metal Work are the best elements for connecting pipes and actuators.

Quick and easy to use, the Metal Work push-in fitting can be re-used thousands of times without affecting the pneumatic and mechanical seal in any way. It comes in various configurations and guarantees a virtually unlimited, highly flexible use. The clamping spring with its special shape grips the pipe without scratching or deforming it, which facilitates release.

In the fittings, the release bushing has patented screwdriver slots to facilitate release in applications not accessible to the fingers.

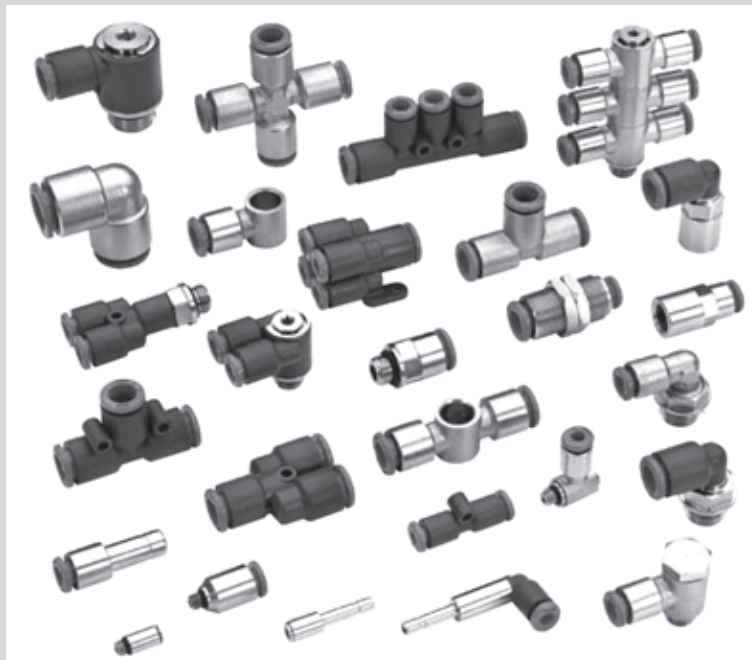

Technical Data

Threaded coupling	M3 - M5 - M7 - 1/8" - 1/4" - 3/8" - 1/2"
Diameter	Ø 3mm - Ø 3.17mm - Ø 4mm - Ø 5mm - Ø 6mm - Ø 8mm - Ø 10mm - Ø 12mm - Ø 14mm
Temperature range for brass fittings	-20 °C to +80 °C -4 °F to 176 °F
Temperature range for technopolymer fittings	-20 °C to +60 °C -4 °F to 140 °F
Pressure range for brass fittings	-0.99 bar ... 16 bar / -0.099 MPa ... 1.6 MPa
Pressure range for technopolymer fittings	-0.99 bar ... 12 bar / -0.099 MPa ... 1.2 MPa
Recommended pipe	Rilsan PA 11 - Nylon 6 - Polyamide 12 - Polypropylene
Fluid	Vacuum - Compressed air

Components

1. Ring or release bushing: technopolymer
2. Locking bushing: brass or technopolymer
3. Body: brass or technopolymer
4. Clamping spring: stainless steel
(for pipes Ø 3 and Ø 3.17 and R31 Ø 5 and R32 Ø 5: brass gripper)
5. Spring supporting ring: technopolymer
6. Seal: NBR

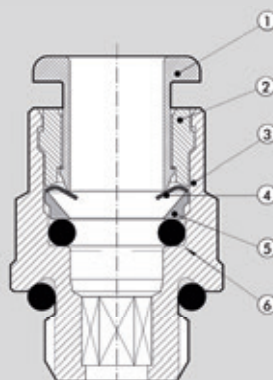

METRIC PUSH-IN FITTINGS, NICKEL PLATED BRASS



Male Stud



BSP Parallel x Tube

9150	Thread BSPP	Tube OD mm
2L01001	M5	4
2L01002	G1/8"	4
2L01003	G1/4"	4
2001005	G1/8"	5
2001006	G1/4"	5
2L01000	M5	6
2L01007	G1/8"	6
2L01008	G1/4"	6
2L01009	G1/8"	8
2L01010	G1/4"	8
2L01011	G3/8"	8
2L01012	G1/4"	10
2L01013	G3/8"	10
2001019	G1/4"	12
2001014	G3/8"	12
2001015	G1/2"	12
2001016	G3/8"	14
2001017	G1/2"	14
2L01018	G1/2"	10

Female Stud



BSP Parallel x Tube

9150	Thread BSPP	Tube OD mm
2L02001	G1/8"	4
2L02002	G1/4"	4
2002003	G1/8"	5
2002004	G1/4"	5
2L02005	G1/8"	6
2L02006	G1/4"	6
2L02007	G1/8"	8
2L02008	G1/4"	8
2L02009	G1/4"	10
2L02010	G3/8"	10
2L02011	G3/8"	12
2L02012	G1/2"	12

Male Stud



BSP Tapered x Tube

9150	Thread BSPT	Tube OD mm
2L01C02	R1/8"	4
2L01C07	R1/8"	6
2L01C08	R1/4"	6
2L01C09	R1/8"	8
2L01C10	R1/4"	8
2L01C11	R3/8"	8

Straight Connector



Tube x Tube

9150	Tube OD mm
2L03001	4
2003002	5
2L03003	6
2L03004	8
2L03005	10
2003006	12
2003007	14

Straight Connector, Reducing



Tube x Tube

9150	Tube OD mm
2L03301	4 6
2L03302	4 8
2L03303	6 8
2L03304	6 10
2L03305	8 10
2L03306	6 12
2L03307	8 12
2L03308	10 12

Bulkhead Connector



Tube x Tube

9150	Bulkhead Thread	Tube OD mm
2L11001	M11	4
2011002	M14	5
2L11003	M13	6
2L11004	M15	8
2L11005	M17	10
2011006	M20	12
2011007	M24	14

Unequal Bulkhead Connector



Tube x Tube

9150	Tube OD mm
2L11301	4 6
2L11302	4 8
2L11303	6 8
2L11304	6 10
2L11305	8 10
2L11306	6 12
2L11307	8 12
2L11308	10 12

Equal Elbow



Tube x Tube

9150	Tube OD mm
2L04001	4
2004002	5
2L04003	6
2L04004	8
2L04005	10
2004006	12
2004007	14

Equal Tee



Tube x Tube

9150	Tube OD mm
2L05001	4
2005002	5
2L05003	6
2L05004	8
2L05005	10
2005006	12
2005007	14

Equal Cross



Tube x Tube

9150	Tube OD mm
2L40003	6
2L40004	8

METRIC PUSH-IN FITTINGS, NICKEL PLATED BRASS



Male Stud Swivel Elbow



BSP Parallel x Tube

9150	Thread BSPP	Tube OD mm
2L31001	M5	4
2L31002	G1/8"	4
2L31003	G1/4"	4
2031004	M5	5
2031005	G1/8"	5
2031006	G1/4"	5
2L31007	M5	6
2L31008	G1/8"	6
2L31009	G1/4"	6
2L31010	G1/8"	8
2L31011	G1/4"	8
2L31012	G3/8"	8
2L31013	G1/4"	10
2L31014	G3/8"	10
2031016	G1/4"	12
2031017	G3/8"	12
2031018	G1/2"	12
2031019	G1/2"	14

Male Rotary Elbow



BSP Tapered x Tube

9150	Thread BSPT	Tube OD mm
2L31C02	R1/8"	4
2L31C03	R1/4"	4
2L31C08	R1/8"	6
2L31C09	R1/4"	6
2L31C10	R1/8"	8
2L31C11	R1/4"	8
2L31C12	R3/8"	8
2L31C13	R1/4"	10
2L31C14	R3/8"	10
2031C15	R3/8"	12
2031C16	R1/2"	12

Male Stud Elbow



BSP Tapered x Tube

9150	Thread BSPT	Tube OD mm
2L39C02	R1/8"	4
2L39C08	R1/8"	6
2L39C09	R1/4"	6
2L39C10	R1/8"	8
2L39C11	R1/4"	8
2L39C13	R1/4"	10

Male Stud Swivel Tee



BSP Parallel & Tube

9150	Thread BSPP	Tube OD mm
2L32002	G1/8"	4
2L32003	G1/4"	4
2032005	G1/8"	5
2L32008	G1/8"	6
2L32009	G1/4"	6
2L32010	G1/8"	8
2L32011	G1/4"	8
2L32012	G3/8"	8
2L32013	G1/4"	10
2L32014	G3/8"	10
2032017	G3/8"	12
2032018	G1/2"	12
2032019	G1/2"	14

Extension Stem



Stem x Stem

9150	Stem OD mm
2007001	4
2007002	5
2007003	6
2L07004	8
2007005	10
2007006	12
2007007	14

Stem Reducer



Stem x Tube

9150	Stem OD mm	Tube OD mm
2008001	5	4
2L08002	6	4
2008003	6	5
2L08004	8	4
2008005	8	5
2L08006	8	6
2L08007	10	6
2L08008	10	8
2008009	12	4
2008010	12	6
2008011	12	8
2008015	12	10
2008014	14	8
2008017	14	10
2008018	14	12

Male Stem Adaptor



BSP Parallel x Tube

9150	Thread BSPP	Stem OD mm
2006001	M5	4
2006002	G1/8"	4
2006003	G1/4"	4
2006004	M5	5
2006005	G1/8"	5
2006006	G1/4"	5
2006000	M5	6
2006007	G1/8"	6
2006008	G1/4"	6
2006009	G1/8"	8
2006010	G1/4"	8
2006011	G3/8"	8
2006012	G1/4"	10
2006013	G3/8"	10
2006019	G1/4"	12
2006014	G3/8"	12
2006015	G1/2"	12
2006016	G3/8"	14
2006017	G1/2"	14

SUPER-RAPID PUSH-IN FITTINGS

Material:

Body nickel plated brass. O-ring NBR seals PTFE/NBR/PA

Working Pressure:

0.8 to 16 bar

Male Stud Couplings



Sprint Parallel Male Stud, BSPP

0158	OD mm	Thread
S6510 4 1/8	4	1/8"
S6510 4 1/4	4	1/4"
S6510 5 1/8	5	1/8"
S6510 5 1/4	5	1/4"
S6510 6 1/8	6	1/8"
S6510 6 1/4	6	1/4"
S6510 8 1/8	8	1/8"
S6510 8 1/4	8	1/4"
S6510 8 3/8	8	3/8"
S6510 10 1/4	10	1/4"
S6510 10 3/8	10	3/8"
S6510 10 1/2	10	1/2"
S6510 12 1/4	12	1/4"
S6510 12 3/8	12	3/8"
S6510 12 1/2	12	1/2"
S6510 14 3/8	14	3/8"
S6510 14 1/2	14	1/2"

Tech Sheet 1861



Parallel Male Stud, BSPP & Metric with O-Ring

0158	OD mm	Thread
6512 4 M5	4	M5
6512 4 M6	4	M6
6512 4 1/8	4	1/8"
6512 4 1/4	4	1/4"
6512 5 M5	5	M5
6512 6 M5	6	M5
6512 6 1/8	6	1/8"
6512 6 1/4	6	1/4"
6512 8 1/8	8	1/8"
6512 8 1/4	8	1/4"
6512 8 3/8	8	3/8"
6512 10 1/4	10	1/4"
6512 10 3/8	10	3/8"
6512 12 1/4	12	1/4"
6512 12 3/8	12	3/8"

Tech Sheet 1861

Female Stud Couplings



Female Stud, BSPP & Metric

0158	OD mm	Thread
6463 4 M5	4	M5
6463 4 1/8	4	1/8"
6463 5 1/8	5	1/8"
6463 6 1/8	6	1/8"
6463 6 1/4	6	1/4"
6463 8 1/8	8	1/8"
6463 8 1/4	8	1/4"
6463 10 1/4	10	1/4"

Tech Sheet 1862

Elbows



Sprint Taper Male Elbow, BSPT

0158	OD mm	Thread
S6500 4 1/8	4	1/8"
S6500 4 1/4	4	1/4"
S6500 5 1/8	5	1/8"
S6500 5 1/4	5	1/4"
S6500 6 1/8	6	1/8"
S6500 6 1/4	6	1/4"
S6500 8 1/8	8	1/8"
S6500 8 1/4	8	1/4"
S6500 8 3/8	8	3/8"
S6500 10 1/4	10	1/4"
S6500 10 3/8	10	3/8"
S6500 12 1/4	12	1/4"
S6500 12 3/8	12	3/8"

Tech Sheet 1863



Sprint Swivel Parallel Male Stud, BSPP

0158	OD mm	Thread
S6520 4 1/8	4	1/8"
S6520 4 1/4	4	1/4"
S6520 5 1/8	5	1/8"
S6520 5 1/4	5	1/4"
S6520 6 1/8	6	1/8"
S6520 6 1/4	6	1/4"
S6520 8 1/8	8	1/8"
S6520 8 1/4	8	1/4"
S6520 8 3/8	8	3/8"
S6520 10 1/4	10	1/4"
S6520 10 3/8	10	3/8"
S6520 10 1/2	10	1/2"
S6520 12 1/4	12	1/4"
S6520 12 3/8	12	3/8"
S6520 12 1/2	12	1/2"
S6520 14 3/8	14	3/8"
S6520 14 1/2	14	1/2"

Tech Sheet 1863



Swivel Parallel Male Elbow, BSPP & Metric with O-Ring

0158	OD mm	Thread
6522 4 M5	4	M5
6522 4 1/8	4	1/8"
6522 4 1/4	4	1/4"
6522 5 M5	5	M5
6522 6 M5	6	M5
6522 6 1/8	6	1/8"
6522 6 1/4	6	1/4"
6522 8 1/8	8	1/8"
6522 8 1/4	8	1/4"
6522 8 3/8	8	3/8"
6522 10 1/4	10	1/4"
6522 10 3/8	10	3/8"
6522 12 1/4	12	1/4"
6522 12 3/8	12	3/8"

Tech Sheet 1863

SUPER-RAPID PUSH-IN FITTINGS

Material:

Body nickel plated brass. O-ring NBR seals PTFE/NBR/PA



Working Pressure:

0.8 to 16 bar

Tees



Sprint Swivel Branch Tee Parallel, BSPP

0158	OD mm	Thread
S6430 4 1/8	4	1/8"
S6430 5 1/8	5	1/8"
S6430 5 1/4	5	1/4"
S6430 6 1/8	6	1/8"
S6430 6 1/4	6	1/4"
S6430 8 1/8	8	1/8"
S6430 8 1/4	8	1/4"
S6430 8 3/8	8	3/8"
S6430 10 1/4	10	1/4"
S6430 10 3/8	10	3/8"
S6430 12 1/4	12	1/4"
S6430 12 3/8	12	3/8"
S6430 12 1/2	12	1/2"
S6430 14 1/2	14	1/2"

Tech Sheet 1864



Swivel Branch Tee Parallel, BSPP & Metric with O-Ring

0158	OD mm	Thread
6432 4 M5	4	M5
6432 4 1/8	4	1/8"
6432 5 M5	5	M5
6432 6 1/8	6	1/8"
6432 6 1/4	6	1/4"
6432 8 1/8	8	1/8"
6432 8 1/4	8	1/4"
6432 8 3/8	8	3/8"
6432 10 1/4	10	1/4"
6432 10 3/8	10	3/8"
6432 12 1/4	12	1/4"
6432 12 3/8	12	3/8"

Tech Sheet 1864



Sprint Swivel Run Tee Parallel, BSPP

0158	OD mm	Thread
S6440 4 1/8	4	1/8"
S6440 5 1/8	5	1/8"
S6440 6 1/8	6	1/8"
S6440 6 1/4	6	1/4"
S6440 8 1/8	8	1/8"
S6440 8 1/4	8	1/4"
S6440 8 3/8	8	3/8"
S6440 10 1/4	10	1/4"
S6440 10 3/8	10	3/8"
S6440 12 3/8	12	3/8"
S6440 14 1/2	14	1/2"

Tech Sheet 1864



Swivel Run Tee Parallel, BSPP & Metric with O-Ring

0158	OD mm	Thread
6442 4 M5	4	M5
6442 4 1/8	4	1/8"
6442 5 M5	5	M5
6442 6 1/8	6	1/8"
6442 6 1/4	6	1/4"
6442 8 1/8	8	1/8"
6442 8 1/4	8	1/4"
6442 8 3/8	8	3/8"
6442 10 1/4	10	1/4"
6442 10 3/8	10	3/8"
6442 12 1/4	12	1/4"
6442 12 3/8	12	3/8"

Tech Sheet 1864

Banjo Bolts



Single Banjo, BSPP & Metric with O-Ring

0158	OD mm	Thread
6622 4 M5	4	M5
6622 4 1/8	4	1/8"
6622 6 1/8	6	1/8"
6622 6 1/4	6	1/4"
6622 8 1/8	8	1/8"
6622 8 1/4	8	1/4"
6622 10 1/4	10	1/4"

Tech Sheet 20121



Double Banjo, BSPP with O-Ring

0158	OD mm	Thread
6632 4 1/8	4	1/8"
6632 6 1/8	6	1/8"
6632 8 1/8	8	1/8"
6632 8 1/4	8	1/4"
6632 10 1/4	10	1/4"

Tech Sheet 1866

Stem Adaptors



Parallel Stem Adaptor, BSPP x Metric

0158	Stem OD mm	Thread
6811 4 M5	4	M5
6811 4 1/8	4	1/8"
6811 5 1/8	5	1/8"
6811 5 1/4	5	1/4"
6811 6 1/8	6	1/8"
6811 6 1/4	6	1/4"
6811 8 1/8	8	1/8"
6811 8 1/4	8	1/4"
6811 10 1/4	10	1/4"
6811 10 3/8	10	3/8"
6811 12 3/8	12	3/8"
6811 14 1/2	14	1/2"

Tech Sheet 20122

SUPER-RAPID PUSH-IN FITTINGS

Material:

Body nickel plated brass. O-ring NBR seals PTFE/NBR/PA

Working Pressure:

0.8 to 16 bar

Tube Connectors



Swivel Y Connector, BSPP & Metric

0158	OD mm	Thread
6451 4 M5	4	M5
S6450 4 1/8	4	1/8"
S6450 6 1/8	6	1/8"
S6450 8 1/8	8	1/8"
S6450 8 1/4	8	1/4"



Equal Y Tube Connector

0158	OD mm
6560 4	4
6560 6	6
6560 8	8
6560 10	10

Tech Sheet 1869



Straight Tube Connector

0158	OD mm
6580 4	4
6580 5	5
6580 6	6
6580 8	8
6580 10	10
6580 12	12
6580 14	14

Tech Sheet 1867



Equal Bulkhead Tube Connector

0158	OD mm	Thread
6590 4	4	M10 x 1
6590 5	5	M12 x 1
6590 6	6	M14 x 1
6590 8	8	M16 x 1
6590 10	10	M18 x 1
6590 12	12	M20 x 1
6590 14	14	M22 x 1

Tech Sheet 20123

Equal Elbow Tube Connector



0158	OD mm
6550 4	4
6550 5	5
6550 6	6
6550 8	8
6550 10	10
6550 12	12
6550 14	14

Tech Sheet 20124



Equal Tee Tube Connector

0158	OD mm
6540 4	4
6540 5	5
6540 6	6
6540 8	8
6540 10	10
6540 12	12
6540 14	14

Tech Sheet 20125



Equal Cross Tube Connector

0158	OD mm
6600 4	4
6600 5	5
6600 6	6
6600 8	8
6600 10	10
6600 12	12

Tech Sheet 20126

Tube/Stem Reducer



0158	Tube OD mm	Stem OD mm
6800 4 5	4	5
6800 4 6	4	6
6800 4 8	4	8
6800 5 6	5	6
6800 5 8	5	8
6800 6 8	6	8
6800 6 10	6	10
6800 6 12	6	12
6800 8 10	8	10
6800 8 12	8	12
6800 10 12	10	12
6800 10 14	10	14
6800 12 14	12	14

Tech Sheet 1870



Tube to Stem Elbow

0158	OD mm	Stem OD mm
6555 4 4	4	4
6555 6 6	6	6
6555 8 8	8	8
6555 10 10	10	10

Tech Sheet 20127

Press Fit Cartridges



Tube

0158	OD mm
6700 4	4
6700 5	5
6700 6	6

Tech Sheet 20128

Blanking Caps & Plugs



Tube Blanking Cap

0158	OD mm
6750 4	4
6750 6	6
6750 8	8
6750 12	12

Tech Sheet 20129



Plastic Blanking Plug

0158	OD mm
6900 4MM	4
6900 5MM	5
6900 6MM	6
6900 8MM	8
6900 10MM	10
6900 12MM	12
6900 14MM	14

SERIES 8000 SUPER-RAPID PUSH-IN FITTINGS

Series 8000 has a patented additional seal that provides a double tight seal on the tube, ensuring a highly reliable connection and avoiding any possible leakage. Connection and disconnection of the tube can be repeated several times without the use of proper tools and without compromising the performance of the fitting or the sealing on the tube

Material:
Body and Gripper: Nickel plated brass
Seals: Nitrile

 **Working Pressure:**
 -0.9 to 16 bar

Male Studs



BSPP

0158	OD mm	Thread
8512 4-1/8	4	1/8"
8512 6-1/8	6	1/8"
8512 6-1/4	6	1/4"
8512 8-1/8	8	1/8"
8512 8-1/4	8	1/4"
8512 10-1/4	10	1/4"
8512 10-3/8	10	3/8"
8512 12-3/8	12	3/8"
8512 12-1/2	12	1/2"

Tech Sheet 68276

Male Stud Swivel Elbows



BSPP

0158	OD mm	Thread
8522 4-1/8	4	1/8"
8522 6-1/8	6	1/8"
8522 6-1/4	6	1/4"
8522 8-1/8	8	1/8"
8522 8-1/4	8	1/4"
8522 10-1/4	10	1/4"
8522 10-3/8	10	3/8"
8522 12-3/8	12	3/8"
8522 12-1/2	12	1/2"

Tech Sheet 68276

Male Stud Swivel Tees



BSPP

0158	OD mm	Thread
8432 4-1/8	4	1/8"
8432 6-1/8	6	1/8"
8432 8-1/8	8	1/8"
8432 8-1/4	8	1/4"

Tech Sheet 68276

Tube x Tube Connectors



Equal Straights

0158	OD mm
8580 4	4
8580 6	6
8580 8	8

Tech Sheet 68276



Equal Tees

0158	OD mm
8540 4	4
8540 6	6
8540 8	8

Tech Sheet 68276



Equal Elbows

0158	OD mm
8550 4	4
8550 6	6
8550 8	8

Tech Sheet 68276

SERIES H8000 DUAL SEAL SUPER-RAPID FITTINGS

Series H8000 fittings are designed to be used in particularly dirty and dusty environments. The patented system, with double tightening on the tube, guarantees a highly reliable connection and avoids any risk of leakage.

Features:

- Protection against dust and debris
- Silicone free
- Suitable for vacuum and metal tubes

Material:

Body and Gripper: Nickel plated brass
Seals: Viton



Working Pressure:

-0.9 to +60 bar

Male Studs



BSPP

0158	OD mm	Thread
H8512 4-1/8-V	4	1/8"
H8512 6-1/4-V	6	1/4"
H8512 6-1/8-V	6	1/8"
H8512 8-1/4-V	8	1/4"
H8512 8-1/8-V	8	1/8"
H8512 8-3/8-V	8	3/8"
H8512 10-1/2-V	10	1/2"
H8512 10-1/4-V	10	1/4"
H8512 10-1/8-V	10	1/8"
H8512 10-3/8-V	10	3/8"
H8512 12-1/2-V	12	1/2"
H8512 12-1/4-V	12	1/4"
H8512 12-3/8-V	12	3/8"
H8512 14-1/2-V	14	1/2"
H8512 14-3/8-V	14	3/8"
H8512 16-1/2-V	16	1/2"
H8512 16-3/8-V	16	3/8"

Tech Sheet 68275

Male Stud Swivel Elbows



BSPP

0158	OD mm	Thread
H8522 4-1/8-V	4	1/8"
H8522 6-1/4-V	6	1/4"
H8522 6-1/8-V	6	1/8"
H8522 8-1/4-V	8	1/8"
H8522 8-1/4-V	8	1/4"
H8522 8-3/8-V	8	3/8"
H8522 10-1/2-V	10	1/2"
H8522 10-1/4-V	10	1/4"
H8522 10-1/8-V	10	1/8"
H8522 10-3/8-V	10	3/8"
H8522 12-1/2-V	12	1/2"
H8522 12-1/4-V	12	1/4"
H8522 12-3/8-V	12	3/8"
H8522 14-1/2-V	14	1/2"
H8522 14-3/8-V	14	3/8"

Tech Sheet 68275

Tube x Tube Connectors



Equal Tees

0158	OD mm
H8540 4-V	4
H8540 6-V	6
H8540 8-V	8
H8540 10-V	10
H8540 12-V	12
H8540 14-V	14

Tech Sheet 68275



Equal Elbows

0158	OD mm
H8550 4-V	4
H8550 6-V	6
H8550 8-V	8
H8550 10-V	10
H8550 12-V	12
H8550 14-V	14

Tech Sheet 68275



Equal Straights

0158	OD mm
H8580 4-V	10
H8580 6-V	6
H8580 8-V	8
H8580 10-V	10
H8580 12-V	12
H8580 14-V	14

Tech Sheet 68275

APPLICATION FIELDS

- › WELDING
- › CUTTING
- › CEMENT PLANT
- › ROADS AND MOTORWAYS
- › PAINTING



stainless steel



All seals have FDA Certification

STAINLESS STEEL PUSH-IN FITTINGS One Touch

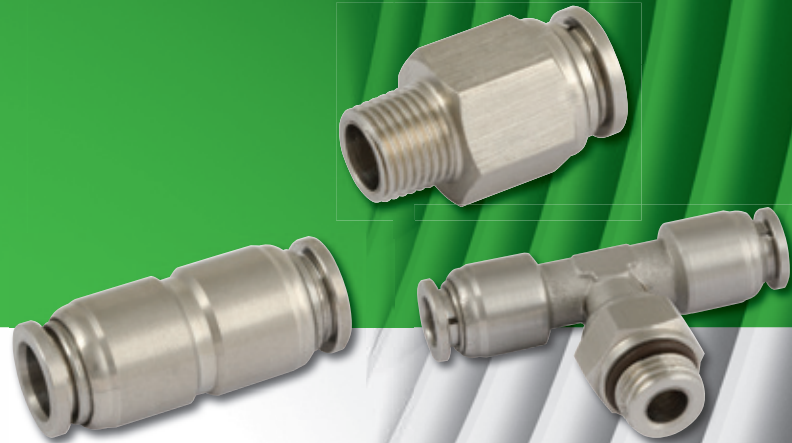

Features:

- Convenient One Touch fittings provide instant connections
- Light manual pressure on the collet ring is all that is required to instantly disconnect each tube, no special tool is required
- Full stainless steel construction prevents corrosion and increases compatibility with more aggressive medias and environments

 **Temperature Range:**
-20°C to +200°C

 **Working Pressure**
10 bar*

*Dependent upon tubing specification.

Construction:

Body & Collet:	316 stainless steel
O-Ring:	Viton (FDA certified)
Tube to Connect:	PU, nylon, PTFE
Media:	Compressed air, steam, water, other compatible liquids

ONE TOUCH ALL STAINLESS STEEL PUSH-IN FITTINGS

stainless steel **FT PRO**

 **Working Temperature:**
-20°C to +200°C

 **Maximum Working Pressure:**
10 bar
Negative Pressure:
750mm Hg (10Torr)

Material:
Body and Collet: 316 stainless steel
O-Ring: Viton

Tube to Connect: PU, Nylon and PTFE
Media: Compressed air, steam water and other compatible liquids

Male Studs



Male Thread, BSPP

0386	OD mm	Thread
SSPC4-01	4	1/8"
SSPC6-01	6	1/8"
SSPC6-02	6	1/4"
SSPC8-01	8	1/8"
SSPC8-02	8	1/4"
SSPC10-02	10	1/4"
SSPC10-03	10	3/8"
SSPC12-04	12	1/2"

Tech Sheet 10257



Male Thread, BSPP

0386	OD mm	Thread
SSPC4-G01	4	1/8"
SSPC6-G01	6	1/8"
SSPC6-G02	6	1/4"
SSPC8-G01	8	1/8"
SSPC8-G02	8	1/4"
SSPC10-G02	10	1/4"
SSPC10-G03	10	3/8"
SSPC12-G04	12	1/2"

Tech Sheet 10257

Female Studs



Female Thread, BSPP

0386	OD mm	Thread
SSPCF4-G01	4	1/8"
SSPCF6-G01	6	1/8"
SSPCF6-G02	6	1/4"
SSPCF8-G01	8	1/8"
SSPCF8-G02	8	1/4"
SSPCF10-G02	10	1/4"
SSPCF10-G03	10	3/8"
SSPCF12-G03	12	3/8"
SSPCF12-G04	12	1/2"

Tech Sheet 10257

Male Stud Swivel Elbows



Male Thread, BSPP

0386	OD mm	Thread
SSPL4-01	4	1/8"
SSPL6-01	6	1/8"
SSPL6-02	6	1/4"
SSPL8-01	8	1/8"
SSPL8-02	8	1/4"
SSPL10-02	10	1/4"
SSPL10-03	10	3/8"
SSPL12-04	12	1/2"

Tech Sheet 10257



Male Thread, BSPP

0386	OD mm	Thread
SSPL4-G01	4	1/8"
SSPL6-G01	6	1/8"
SSPL6-G02	6	1/4"
SSPL8-G01	8	1/8"
SSPL8-G02	8	1/4"
SSPL10-G02	10	1/4"
SSPL10-G03	10	3/8"
SSPL12-G04	12	1/2"

Tech Sheet 10257

Female Stud Elbows



Female Thread, BSPP

0386	OD mm	Thread
SSPLF4-G01	4	1/8"
SSPLF6-G01	6	1/8"
SSPLF6-G02	6	1/4"
SSPLF8-G01	8	1/8"
SSPLF8-G02	8	1/4"
SSPLF10-G02	10	1/4"
SSPLF10-G03	10	3/8"
SSPLF12-G03	12	3/8"
SSPLF12-G04	12	1/2"

Tech Sheet 10257

Male Stud Swivel Tees



Branch Male Thread, BSPP

0386	OD mm	Thread
SSPB4-G01	4	1/8"
SSPB6-G01	6	1/8"
SSPB6-G02	6	1/4"
SSPB8-G01	8	1/8"
SSPB8-G02	8	1/4"
SSPB10-G02	10	1/4"
SSPB10-G03	10	3/8"
SSPB12-G03	12	3/8"
SSPB12-G04	12	1/2"

Tech Sheet 10257

Speed Control Valves



Male Thread, BSPP

0386	OD mm	Thread
SSNSE4-G01	4	1/8"
SSNSE6-G01	6	1/8"
SSNSE6-G02	6	1/4"
SSNSE8-G01	8	1/8"
SSNSE8-G02	8	1/4"
SSNSE8-G03	8	3/8"
SSNSE10-G02	10	1/4"
SSNSE10-G03	10	3/8"
SSNSE10-G04	10	1/2"
SSNSE12-G04	12	1/2"

Tech Sheet 10257



All seals have FDA Certification

ONE TOUCH ALL STAINLESS STEEL PUSH-IN FITTINGS

stainless steel **FT PRO**

 **Working Temperature:**
-20°C to +200°C

 **Maximum Working Pressure:**
10 bar
Negative Pressure:
750mm Hg (10Torr)

Material:
Body and Collet: 316 stainless steel
O-Ring: Viton

Tube to Connect: PU, Nylon and PTFE
Media: Compressed air, steam water and other compatible liquids

Tube x Tube Connectors



Equal Straights

0386	OD mm
SSPUC-4	4
SSPUC-6	6
SSPUC-8	8
SSPUC-10	10
SSPUC-12	12

Tech Sheet 10257



Unequal Straights

0386	OD mm	OD mm
SSPG6-4	6	4
SSPG8-4	8	4
SSPG8-6	8	6
SSPG10-6	10	6
SSPG10-8	10	8
SSPG12-8	12	8
SSPG12-10	12	10

Tech Sheet 10257



Equal Elbows

0386	OD mm
SSPUL-4	4
SSPUL-6	6
SSPUL-8	8
SSPUL-10	10
SSPUL-12	12

Tech Sheet 10257



Equal Tees

0386	OD mm
SSPUT-4	4
SSPUT-6	6
SSPUT-8	8
SSPUT-10	10
SSPUT-12	12

Tech Sheet 10257



Equal Bulkheads

0386	OD mm
SSPM-4	4
SSPM-6	6
SSPM-8	8
SSPM-10	10
SSPM-12	12

Tech Sheet 10257



Equal Ys

0386	OD mm
SSPY-4	4
SSPY-6	6
SSPY-8	8
SSPY-10	10
SSPY-12	12

Tech Sheet 10257

Stem Connectors



Tube x Stem Reducers

0386	OD mm	OD mm
SSPGJ6-4	6	4
SSPGJ8-4	8	4
SSPGJ8-6	8	6
SSPGJ10-6	10	6
SSPGJ10-8	10	8
SSPGJ12-8	12	8
SSPGJ12-10	12	10

Tech Sheet 10257

Plugs



Tube

0386	OD mm
SSPP-4	4
SSPP-6	6
SSPP-8	8
SSPP-10	10
SSPP-12	12

Tech Sheet 10257



All seals have FDA Certification

316 STAINLESS STEEL PUSH-IN FITTINGS



Working Temperature:
-15°C to +190°C



Maximum Working Pressure:
-0.99 bar to 20 bar



stainless
steel



This series is fully made of stainless steel AISI 316L and developed to be used with aggressive fluids and food applications. Also ideal for use in salty environments and in machines that need frequent washing with aggressive detergents. Certified NSF 169 and conformed to NSF 61 & NSF 372 standards. All parallel threads have a Food FKM seal as standard.

Male Studs



Male Thread, BSPT

0006	OD mm	Thread
60000-4-1/8	4	1/8"
60000-4-1/4	4	1/4"
60000-6-1/8	6	1/8"
60000-6-1/4	6	1/4"
60000-8-1/8	8	1/8"
60000-8-1/4	8	1/4"
60000-10-1/4	10	1/4"
60000-10-3/8	10	3/8"
60000-12-3/8	12	3/8"
60000-12-1/2	12	1/2"

Tech Sheet 1378



Male Thread, Metric & BSPP

0006	OD mm	Thread
60020-4-M5	4	M5
60020-4-1/8	4	1/8"
60020-4-1/4	4	1/4"
60020-6-M5	6	M5
60020-6-1/8	6	1/8"
60020-6-1/4	6	1/4"
60020-8-1/8	8	1/8"
60020-8-1/4	8	1/4"
60020-10-1/4	10	1/4"
60020-10-3/8	10	3/8"
60020-10-1/2	10	1/2"
60020-12-3/8	12	3/8"
60020-12-1/2	12	1/2"
60020-14-1/2	14	1/2"

Tech Sheet 1378

Male Stud Swivel Elbows



Male Thread, BSPT

0006	OD mm	Thread
60110X-4-18	4	1/8"
60110X-4-14	4	1/4"
60110X-6-18	6	1/8"
60110X-6-14	6	1/4"
60110X-8-18	8	1/8"
60110X-8-14	8	1/4"
60110X-10-14	10	1/4"
60110X-10-38	10	3/8"
60110X-10-12	10	1/2"
60110X-12-38	12	3/8"
60110X-12-12	12	1/2"

Tech Sheet 1378



Male Thread, Metric & BSPP

0006	OD mm	Thread
60115X-4-M5	4	M5
60115X-4-18	4	1/8"
60115X-4-14	4	1/4"
60115X-6-M5	6	M5
60115X-6-18	6	1/8"
60115X-6-14	6	1/4"
60115X-6-38	6	3/8"
60115X-8-18	8	1/8"
60115X-8-14	8	1/4"
60115X-8-38	8	3/8"
60115X-10-14	10	1/4"
60115X-10-38	10	3/8"
60115X-10-12	10	1/2"
60115X-12-38	12	3/8"
60115X-12-12	12	1/2"
60115X-14-12	14	1/2"

Tech Sheet 1378

Male Stud Swivel Tees



Branch Male Thread, BSPT

0006	OD mm	Thread
60210X-4-18	4	1/8"
60210X-4-14	4	1/4"
60210X-6-18	6	1/8"
60210X-6-14	6	1/4"
60210X-8-18	8	1/8"
60210X-8-14	8	1/4"
60210X-10-14	10	1/4"
60210X-10-38	10	3/8"
60210X-10-12	10	1/2"
60210X-12-38	12	3/8"
60210X-12-12	12	1/2"

Tech Sheet 1378



Branch Male Thread, BSPP

0006	OD mm	Thread
60215X-4-M5	4	M5
60215X-4-14	4	1/4"
60215X-6-M5	6	M5
60215X-6-18	6	1/8"
60215X-6-14	6	1/4"
60215X-8-18	8	1/8"
60215X-8-14	8	1/4"
60215X-10-14	10	1/4"
60215X-10-38	10	3/8"
60215X-10-12	10	1/2"
60215X-12-38	12	3/8"
60215X-12-12	12	1/2"
60215X-14-12	14	1/2"

Tech Sheet 1378

316 STAINLESS STEEL PUSH-IN FITTINGS



stainless
steel

AIGNEP

° Working Temperature:
-15°C to +190°C

Maximum Working
Pressure:
-0.99 bar to 20 bar

This series is fully made of stainless steel AISI 316L and developed to be used with aggressive fluids and food applications. Also ideal for use in salty environments and in machines that need frequent washing with aggressive detergents. Certified NSF 169 and conformed to NSF 61 & NSF 372 standards. All parallel threads have a Food FKM seal as standard.

Tube x Tube Connectors



Equal Straights

0006	OD mm
60040-4	4
60040-6	6
60040-8	8
60040-10	10
60040-12	12
60040-14	14

Tech Sheet 1378



Unequal Straights

0006	OD mm	OD mm
60040-4-6	4	6
60040-6-8	6	8
60040-8-10	8	10
60040-10-12	10	12

Tech Sheet 1378



Equal Bulkheads

0006	OD mm	Thread
60050-4	4	M12 x 1
60050-6	6	M14 x 1
60050-8	8	M16 x 1
60050-10	10	M20 x 1
60050-12	12	M22 x 1

Tech Sheet 1378



Equal Ys

0006	OD mm
60310X-4	4
60310X-6	6
60310X-8	8

Tech Sheet 1378



Equal Elbows

0006	OD mm
60130X-4	4
60130X-6	6
60130X-8	8
60130X-10	10
60130X-12	12
60130X-14	14

Tech Sheet 1378



Equal Tees

0006	OD mm
60230X-4	4
60230X-6	6
60230X-8	8
60230X-10	10
60230X-12	12
60230X-14	14

Tech Sheet 1378

Stem Adaptors



Male Thread, BSPP

0006	OD mm	Thread
60600-6-18	6	1/8"
60600-8-14	8	1/4"
60600-10-14	10	1/4"
60600-10-38	10	3/8"
60600-12-38	12	3/8"
60600-12-12	12	1/2"

Tech Sheet 1378

PLASTIC PLUMBING PUSH-IN FITTINGS

Couplings



Straight

1400	OD mm
PEM0410W	10
PKM0415W	15
PKM0422W	22
PEM0428W	28

Tech Sheet 20630



Reducing

1400	OD mm	OD mm
PKM201510W	15	10
PKM202215W	22	15

Tech Sheet 20630



BSPP Female to Tap Connector

1400	OD mm	Thread
PEM3210W	10	1/2"
PEM3201W	15	1/2"
PEM3203W	15	3/4"
PEM3202W	22	3/4"

Tech Sheet 20630

Pipe Inserts

To be used on installation when using plastic pipe.



1400	To Suit ID mm
TSM10N	10
TSM15N	15
TSM22N	22
TSM28N	28

Tech Sheet 20630

Elbows



Equal

1400	OD mm
PEM0310W	10
PKM0315W	15
PKM0322W	22
PEM03228W	28

Tech Sheet 20630

- Provides a swivel type connection.



Stem

1400	OD mm	Stem OD mm
PEM221010W	10	10
PKM221515W	15	15
PKM222222W	22	22

Tech Sheet 20630



Brass Wing Back, BSPP Female

1400	OD mm	Thread
15WB	15	1/2"
22WB	22	3/4"

Tech Sheet 20630

End Stops



1400	OD mm
PSE4610W	10
PKM4615W	15
PKM4622W	22

Tech Sheet 20630

Tees



Equal

1400	OD mm
PEM0210W	10
PKM0215W	15
PKM0222W	22
PEM0228W	28

Tech Sheet 20630



Increasing on Branch

1400	OD A mm	OD B mm
PKM3022CW	15	22

Tech Sheet 20630



Reducing on Branch

1400	OD A mm	OD B mm
PEM3015BW	15	10
PEM3015AW	15	10
PEM302210AW	22	10
PKM3022AW	22	15
PEM3028AW	28	22



Increasing on Run

1400	OD A mm	OD B mm
PEM3022BW	22	15

Tech Sheet 20630



Reducing on Run

1400	OD A mm	OD B mm
PKM3022DW	22	15
PEM3028DW	28	22

PLASTIC PLUMBING PUSH-IN FITTINGS



Reducers



1400	OD mm	Stem OD mm
PEM061510W	10	15
PEM062215W	15	22
PEM062815W	15	28
PEM062822W	22	28

Tech Sheet 20630

Connectors



Tap, BSPP Female

1400	OD mm	Thread
PKMSTC1514	15	1/2" Straight
PKMSTC1516	15	3/4" Straight
PKMSTC2216	22	3/4" Straight

Tech Sheet 20630

Maximum wall thickness of tank = 4mm.

Note: Requires hand tightening only.



Tank

1400	OD mm
CM0715S	15
CM0722S	22
CM0728S	28

Tech Sheet 20630

Brass Drain Cock

Speedfit Drain Cocks cannot be used where collet covers are fitted. They can be used with a standard fitting fitte with a collet clip.



1400	OD mm
15BDC	15

Tech Sheet 20630

Service Valves

N.B: Hot and cold water only 65°C max.
Not suitable for central heating systems.



Plastic

1400	OD mm
15ISV	15

Tech Sheet 20630



Brass Chrome Plated

1400	OD mm
10HSV	10
15HSV	15
22HSV	22

Tech Sheet 20630



Brass Chrome Plated with Tap Connector BSPP Female

1400	OD mm	Thread
15PTS	15	1/2"

Tech Sheet 20630

Brass Chrome Plated Ball Valves

Suitable for central heating systems, each valve has a red and blue indice.



1400	OD mm
10BV	10
15BV	15
22BV	22

Tech Sheet 20630

Valves

N.B. Hot and cold water only 65°C max.



Stop

1400	OD mm
15STV	15
22STV	22

Tech Sheet 20630



Brass Stop

1400	OD mm
15BSC	15

Tech Sheet 20630

N.B. Hot and cold water only 65°C max.
Not suitable for central heating systems.



Double Check

1400	OD mm
15DCV	15

Tech Sheet 20630

Taps



Emergency Shut Off

1400	OD mm
15ESOT	15

Tech Sheet 20630

N.B. Hot and cold water only 65°C max.



Washing Machine, BSPP

1400	OD mm	Thread
15APT-B	15	3/4"

Tech Sheet 20630

PLASTIC PLUMBING PUSH-IN FITTINGS, PIPES & CUTTERS

Barrier Pipes

British Gas accepted for water pipe in vented and sealed central heating systems. The pipe has an inner barrier to stop the ingress of atmosphere.



Pex Coils

1400	OD mm	Length Metres
10BPEX-25C	10	25
10BPEX-50C	10	50
15BPEX-25C	15	25
15BPEX-50C	15	50
15BPEX-100C	15	100
22BPEX-25C	22	25
22BPEX-50C	22	50

Tech Sheet 20363

This pipe is made from a soft material with little memory ensuring a flexible system. It has an inner barrier to stop the ingress of atmosphere. British Gas accepted for water pipe in vented and sealed central heating systems.

- Easy to handle
- Ultra flexible



Layflat Polybutylen

1400	OD mm	Length Metres
15BPB-25C	15	25
15BPB-50C	15	50
15BPB-100C	15	100
22BPB-25C	22	25
22BPB-50C	22	50

Tech Sheet 20363

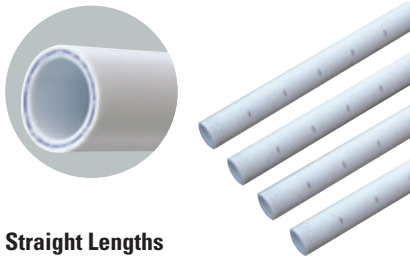

Straight Lengths

1400	OD mm	Length Metres	Quantity
15BPEX-20X2L	15	2	20
15BPEX-20X3L	15	3	20
22BPEX-20X2L	22	2	20
22BPEX-20X3L	22	3	20
28BPEX-10X3L	28	3	10

Tech Sheet 20363

Flexi Hoses



Push-in to BSPP Female

1400	OD mm	Thread	Length mm
FLX15	15	1/2"	300
FLX18	15	1/2"	500
FLX16	15	3/4"	300
FLX20	15	3/4"	500
FLX22	22	3/4"	300
FLX19	22	3/4"	500

Tech Sheet 20630



Push-in to Push-in

1400	OD mm	OD mm	Length mm
FLX33	15	10	300
FLX17	15	15	300
FLX21	15	15	500
FLX26	22	22	300
FLX27	22	22	500

Tech Sheet 20630



Push-in to BSPP Female with Service Valve

1400	OD mm	Thread	Length mm
FLX37	15	1/2"	300 Full Bore
FLX24	15	1/2"	300

Tech Sheet 20630

N.B. Hot & cold water only, 65°C maximum



Elbow

1400	OD mm	Thread	Length mm
FLX36	15	1/2"	300

Tech Sheet 20630

Adaptors

Brass Male Cylinder, BSPP

1400	OD mm	Thread
22CMA	22	1"

Tech Sheet 20630



Brass Female Cylinder, BSPP

1400	OD mm	Thread
22CFA	22	1"

Tech Sheet 20630

Cutters



Heavy-duty Pipe Cutter

1400	Pipe Size
JG-HDC	Up to 28 mm



Aluminium Pipe Cutter

1400	OD mm
ALU-CUTTER15	15
ALU-CUTTER22	22
ALU-CUTTER28	28

Tech Sheet 20629

John Guest Plumbing Range



Radiator Key

1400	Description
RK1C	Brass Key



Male Coupler - Brass

1400	Size mm	Thread
10MC	10	1/2" BSPP
15MC	15	1/2" BSPP
MW011504N	15	1/2" BSPT
22MC	22	3/4" BSPP
MW012206N	22	3/4" BSPT
MW012818N	28	1" BSPP
MW012808N	28	1" BSPT



Hose Connector

1400	Size mm	Hose ID
NC448	15	1/2"
NC473	22	3/4"



Conversion Connector

1400	Size mm	OD
NC471	15	5/8"



Slip Connector

1400	Size mm
CM-SC-15S	15



PE Copper Coupler

1400	Size mm
JG603B	25 x 15



45° Stem Elbow

1400	Pipe mm	Stem mm
PEM571515W	15	15
PEM572222W	22	22



Bend Tap Connector, Female Thread, BSPP

1400	Size mm	Thread
PEMBTC1514	15	1/2"



Stem Tee

1400	Size mm
PEM532210W	22 x 22 x 10
PEM532215W	22 x 22 x 15



4 Port Rail Manifold

1400	Size mm
SFM522210S	22 x 10
SFM522215S	22 x 15



4 Way Manifold

1400	Size mm
SFM512210S	22 x 10



Male Stem Adaptor, Brass, BSPT

1400	Size mm	Thread
MW052206N	22	3/4"
MW052818N	28	1"



Female Stem Adaptor, Brass, BSPP

1400	Size mm	Thread
MW502216N	22	3/4"



Pipe Adaptor, Brass

1400	Thread	Size mm
NC2239	3/4"	22

John Guest Plumbing Range

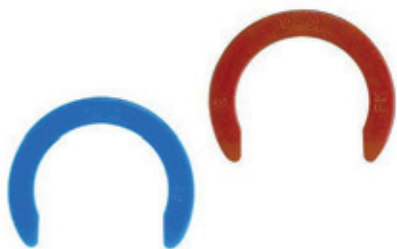

Collet Locking Clip

1400	Size mm	Colour
CM1815B	15	Blue
CM1815R	15	Red



Collet Cover

1400	Colour	Size mm
AM1915W	White	15
PM1915B	Blue	15



Collets

1400	Size mm
PXC10	10



EPDM O Ring

1400	Size mm
10EPR	10



Thread Washer

1400	Size
1/2EPW	1/2"



Shut Off Valve, Imperial & Metric

1400	Tube OD 1	Tube OD 2
PPMSV040606W	6mm	6mm
PPMSV041010W	10mm	10mm
PPSV040808W	1/4"	1/4"
PPSV041212W	3/8"	3/8"



Shut Off Valve, Long Handle

1400	Tube OD
PISV0412S	3/8"
PISV0416S	1/2"



Shut Off Valve, Male Thread, NPT

1400	Tube OD	Thread
PPSV010822W	1/4"	1/4"
PPSV011223W	3/8"	3/8"



Shut Off Valve, Female Thread, NPT

1400	Tube OD	Thread
PPSV500822W	1/4"	1/4"



Mounting Clip

1400	Size
SVMC-10	3/8" Shut Off Valve Clip



Single Check Valve

1400	Tube OD mm
6SCV	6
10SCV	10
5/16SCV	5/16"



Conduit Pipe

1400	Size mm	Length Metres
22BLKCON-25C	22	25



Bending Spring

1400	Size mm
JG-BS15	15



Superseal Pipe Insert

1400	Size mm
STS15	15
STS22	22
STS28	28



Pipe Clips & Spacers

1400	Size mm	Colour
PC15W	15	White
PC22W	22	White
PC28W	28	White
PCSW	Spacer	White



Nail Clip

1400	Size mm	Colour
NPC15	15	White

BRASS PUSH-IN PLUMBING TUBE FITTINGS



ITAP-FIT® Fitting

Suitable for:

Copper, PEX and Polybutylene pipe.

Working Temperature:
-20°C to +120°C

Maximum Working Pressure:
Copper Pipe: 20 bar @ 25°C, 10 bar @ 90°C
PEX and Polybutylene Pipe: 12 bar @ 25°C, 5 bar @ 90°C



Female Stud Coupling

0089	OD mm	Thread
610B038012	12	3/8"
610B012012	12	1/2"
610B012014	14	1/2"
610B012015	15	1/2"
610B012016	16	1/2"
610B012018	18	1/2"
610B012020	20	1/2"
610B034018	18	3/4"
610B034022	22	3/4"
610B034025	25	3/4"
610B100028	28	1"

Tech Sheet 10533



Male Stud Coupling

0089	OD mm	Thread
615B038012	12	3/8"
615B038014	14	3/8"
615B012012	12	1/2"
615B012014	14	1/2"
615B012015	15	1/2"
615B012016	16	1/2"
615B012018	18	1/2"
615B012020	20	1/2"
615B034018	18	3/4"
615B034022	22	3/4"
615B034025	25	3/4"
615B100028	28	1"

Tech Sheet 10533



Female Stud 90° Elbow, BSPT

0089	OD mm	Thread
645B038012	12	3/8"
645B012012	12	1/2"
645B012014	14	1/2"
645B012015	15	1/2"
645B012016	16	1/2"
645B012018	18	1/2"
645B012020	20	1/2"
645B034018	18	3/4"
645B034022	22	3/4"
645B034025	25	3/4"
645B100028	28	1"

Tech Sheet 10533



Female Stud 90° Elbow (Wall Mount), BSPT

0089	OD mm	Thread
648B038012	12	3/8"
648B012012	12	1/2"
648B012014	14	1/2"
648B012015	15	1/2"
648B012016	16	1/2"
648B012018	18	1/2"
648B012020	20	1/2"
648B034018	18	3/4"
648B034022	22	3/4"

Tech Sheet 10533



Male Stud 90° Elbow, BSPT

0089	OD mm	Thread
640B038012	12	3/8"
640B012012	12	1/2"
640B012014	14	1/2"
640B012015	15	1/2"
640B012016	16	1/2"
640B012018	18	1/2"
640B012020	20	1/2"
640B034018	18	3/4"
640B034022	22	3/4"
640B034025	25	3/4"
640B100028	28	1"

Tech Sheet 10533



Female Branch Tee, BSPT

0089	OD mm	Thread
635B012014	14	1/2"
635B012015	15	1/2"
635B012016	16	1/2"
635B012018	18	1/2"
635B012020	20	1/2"
635B034018	18	3/4"
635B034022	22	3/4"
635B034025	25	3/4"
635B100028	28	1"

Tech Sheet 10533



Disconnecting Clip

0089	OD mm
671012	12
671014	14
671015	15
671016	16
671018	18
671020	20
671022	22
671025	25
671028	28

Tech Sheet 10533



Depth Gauge

0089
685012028

Tech Sheet 10533

BRASS PUSH-IN PLUMBING TUBE FITTINGS



ITAP-FIT® Fitting

Suitable for:
Copper, PEX and Polybutylene pipe

Working Temperature:
-20°C to +120°C

Maximum Working Pressure:
Copper Pipe: 20 bar @ 25°C, 10 bar @ 90°C
PEX and Polybutylene Pipe: 12 bar @ 25°C, 5 bar @ 90°C



Straight

0089	OD mm
620C000012	12
620C000014	14
620C000015	15
620C000016	16
620C000018	18
620C000020	20
620C000022	22
620C000025	25
620C000028	28
Tech Sheet 10533	



End Stop

0089	OD mm
625C000012	12
625C000014	14
625C000015	15
625C000016	16
625C000018	18
625C000020	20
625C000022	22
Tech Sheet 10533	



O-Ring

0089	OD mm
656EP012	12
656EP014	14
656EP015	15
656EP016	16
656EP018	18
656EP020	20
656EP022	22
656EP025	25
656EP028	28
Tech Sheet 10533	



Equal 90° Elbow

0089	OD mm
650C000012	12
650C000014	14
650C000015	15
650C000016	16
650C000018	18
650C000020	20
650C000022	22
650C000025	25
650C000028	28
Tech Sheet 10533	



Tube Liner

0089	To Suit
655BU012110	12 x 1.1
655BU012180	12 x 1.8
655BU012200	12 x 2.0
655BU015180	15 x 1.8
655BU015250	15 x 2.5
655BU016150	16 x 1.5
655BU016180	16 x 1.8
655BU016200	16 x 2.0
655BU018200	18 x 2.0
655BU020190	20 x 1.9
655BU020280	20 x 2.8
655BU022200	22 x 2.0
655BU025230	25 x 2.3
655BU025250	25 x 2.5
655BU028280	28 x 2.8
655BU028300	28 x 3.0
Tech Sheet 10533	



Spacer

0089	OD mm
657DI012	12
657DI014	14
657DI015	15
657DI016	16
657DI018	18
657DI020	20
657DI022	22
657DI025	25
657DI028	28
Tech Sheet 10533	



Equal Tee

0089	OD mm
630C000012	12
630C000014	14
630C000015	15
630C000016	16
630C000018	18
630C000020	20
630C000022	22
630C000025	25
630C000028	28
Tech Sheet 10533	



Ring

0089	OD mm
658AG012	12
658AG014	14
658AG015	15
658AG016	16
658AG018	18
658AG020	20
658AG022	22
658AG025	25
658AG028	28
Tech Sheet 10533	

AIR BRAKE FITTINGS

Male Stud Couplings Mix Box

Contains:

2 x M12 x 8, 2 x M16 x 12, 2 x M16 x 8,
2 x M22 x 12, 2 x M16 x 10, 1 x M22 x 15,
2 x M22 x 10, 1 x M22 x 18



14 Piece

1360
008ABK

Male Stud Elbow Mix Box

Contains:

2 x M12 x 8, 1 x M22 x 10, 2 x M16 x 8,
1 x M16 x 12, 2 x M22 x 8, 1 x M22 x 12,
2 x M12 x 10, 1 x M22 x 15, 2 x M16 x 10,
1 x M22 x 18

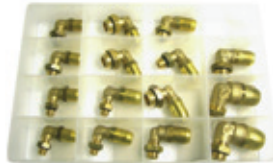

15 Piece

1360
081ABK

Straight Connectors Mix Box

Contains:

2 x 6 mm, 2 x 12 mm, 2 x 8 mm,
2 x 15 mm, 2 x 10 mm, 2 x 16 mm,
1 x 18 mm



15 Piece

1360
085ABK

Workshop & Mobile Full Repair/Service Kit



120 Piece

1360
086ABK

Male Studs



Metric

1360	OD mm	Thread
800212ABF	6	M12
800216ABF	6	M16
800312ABF	8	M12
800316ABF	8	M16
800322ABF	8	M22
800412ABF	10	M12
800416ABF	10	M16
800422ABF	10	M22
800516ABF	12	M16
800522ABF	12	M22
800622ABF	15	M22
800722ABF	16	M22
800822ABF	18	M22
800826ABF	18	M26

Male Stud Elbows



Metric

1360	OD mm	Thread
810212ABF	6	M12
810216ABF	6	M16
810312ABF	8	M12
810316ABF	8	M16
810322ABF	8	M22
810412ABF	10	M12
810416ABF	10	M16
810422ABF	10	M22
810516ABF	12	M16
810522ABF	12	M22
810622ABF	15	M22
810722ABF	16	M22
810822ABF	18	M22

Bulkheads



Metric

1360	Thread
703222ABF	M22 x M16 x F10 mm
703322ABF	M22 x M18 x F12 mm
703522ABF	M22 x M22 x F16 mm

Hex Straight



Metric

1360	Thread
750300ABF	M12
750500ABF	M16
750700ABF	M22

AIR BRAKE FITTINGS

Straight Joiners



Tube

1360	OD mm
850200ABF	6
850300ABF	8
850400ABF	10
850500ABF	12
850600ABF	15
850700ABF	16
850800ABF	18

Elbow Joiners



Tube

1360	OD mm
860200ABF	6
860300ABF	8
860900ABF	9
860400ABF	10
860110ABF	11
860500ABF	12
860600ABF	15
860700ABF	16
860800ABF	18

Tee Joiners



Tube

1360	OD mm
870200ABF	6
870300ABF	8
870400ABF	10
870500ABF	12
870600ABF	15

Elbows



Female Thread, Metric

1360	Thread
760300ABF	M12
760500ABF	M16
760700ABF	M22



Male Thread x Female Thread, Metric

1360	Male Thread	Female Thread
710312ABF	M12	M12
710316ABF	M16	M12
710322ABF	M22	M12
710516ABF	M16	M16
710522ABF	M22	M16
710722ABF	M22	M22

F Elbow, Male Thread x Female Thread, Metric



1360	Male Thread	Female Thread
743516ABF	M16	M16

45° Elbow, Male Thread x Female Thread, Metric



1360	Male Thread	Female Thread
740516ABF	M16	M16
740722ABF	M22	M22

Tees



Female Thread, Metric

1360	Thread
770300ABF	M12
770500ABF	M16
770700ABF	M22



Male Thread x Female Thread, Metric

1360	Male Thread	Female Thread
730312ABF	M12	M12
730316ABF	M16	M12
730322ABF	M22	M12
730516ABF	M16	M16
730522ABF	M22	M16
730722ABF	M22	M22

Stud Run Tee



Male Thread x Female Thread, Metric

1360	Male Thread	Female Thread
720312ABF	M12	M12
720316ABF	M16	M12
720322ABF	M22	M12
720516ABF	M16	M16
720522ABF	M22	M16
720722ABF	M22	M22

AIR BRAKE FITTINGS



Test Points



Male Thread, Metric

1360	Thread
TPM12T	M12
TPM16T	M16
TPM22T	M22

Drain Taps



Male Thread, Metric

1360	Thread
TT3T	M22

Blanking Plugs



Male Thread, Metric

1360	Thread
BP12B	M12
BP16B	M16
BP22B	M22

AIR BRAKE SWIVEL FITTINGS



Male Studs



Male Thread, Metric

1360	Thread
660502ABF	1/8"
660504ABF	1/4"
660510ABF	M10
660512ABF	M12
660514ABF	M14
660516ABF	M16
660522ABF	M22
660526ABF	M26

Elbow



Female Thread, Metric

1360	Thread
615500ABF	M16

45° Elbow



Female Thread, Metric

1360	Thread
645500ABF	M16

Elbow Joiners



Tube

1360	Tube OD mm
815200ABF	6
815300ABF	8
815400ABF	10
815500ABF	12

Tee



Female Thread, Metric

1360	Thread
635500ABF	2 x M16

Side Tee



Female Thread, Metric

1360	Thread
625500ABF	2 x M16

Cross



Female Thread, Metric

1360	Tube OD mm
646500ABF	3 x M16

Series 9000 C-Truck

Brass fittings



Automation



The safe and practical solution for pneumatic braking systems

Series 9000 C-Truck fittings have been designed to connect tubes in the pneumatic braking systems on industrial and commercial vehicles ensuring reliability and ease of assembling. The use of a proper disconnection tool enables disconnection of the tube without having to remove the fitting. All fittings have a protective cap that keeps humidity and dirt away from the collet. A reinforced insert enables the dimensions of the tube to remain constant, thus ensuring a tight and safe connection even with high changes in temperature. Indeed, Series 9000 C-Truck fittings can be used at extreme temperatures (from -50°C to $+100^{\circ}\text{C}$). They are assembled according to a precise angle and supplied with locking nut and a self sealing O-ring. The O-ring on the thread is set in a special groove of the threaded part, ensuring there is no damage during assembly. The brass body guarantees a high resistance to corrosion, whilst the O-ring and protective cap are made from oil resistant rubber. All fittings are supplied pre-assembled and ready to use.



General Data

Materials: see table of materials

Thread: Metric NPT

Media: Compressed air

Max working pressure: 16 bar

Note: pressure depends on tube characteristics

Temperature: $-50^{\circ}\text{C} \div +100^{\circ}\text{C}$

Tube: Material Polyamide

Tube diameters (D/d): 4/2, 6/4, 8/6, 10/7, 10/8, 12/9, 15/11, 15/12, 16/12, 16/13 and 18/14

 Certification

Camozzi
Air that moves the world

AIR BRAKE PUSH-IN FITTINGS C-TRUCK 9000 SERIES

Table of Materials

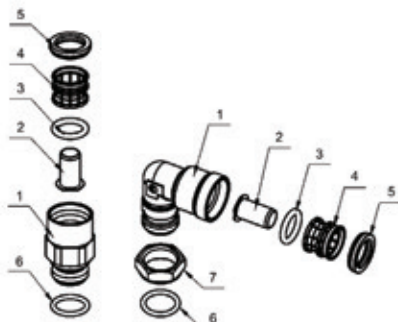

Parts	Materials
1 = Body	Brass
2 = Insert	Technopolymer (Brass only for Ø10/7, 15/11, 16/12, 16/13 and 18/14)
3 = S-rapid	O-Ring NBR
4 = Collet	Brass
5 = Protective seal	NBR
6 = O-Ring for thread	NBR
7 = Locking ring	Steel

Fittings Assembly in the System

To guarantee the tightening of the fitting in the system, make sure that the thread chamfer conforms to the standard ISO 965 or GOST 10549-80.

The fittings which have an O-Ring seal on the thread, but no locking nut, have to be screwed into the system with the torque forces as shown in the table below.

For the assembly of fittings with locking nut, it is necessary to do the following:

1. Loosen the locking nut
2. Screw the fitting into the system until the O-Ring comes into contact with the system surface
3. Position the fitting according to the suitable angle, moving the body up to 360°
4. Keep the body still
5. Screw the locking nut with torque forces as shown in the table

Thread	Torque force (Nm)
M10 x 1	11 - 15
M12 x 1.5	15 - 19
M14 x 1.5	19 - 23
M16 x 1.5	24 - 30
M18 x 1.5	27 - 33
M22 x 1.5	36 - 44

Straight Adaptors



Male, Metric

0322	Thread	OD mm
9512-6-M10	M10 x 1	6
9512-6-M12	M12 x 1.5	6
9512-6-M14	M14 x 1.5	6
9512-6-M16	M16 x 1.5	6
9512-8-M10	M10 x 1	8
9512-8-M12	M12 x 1.5	8
9512-8-M14	M14 x 1.5	8
9512-8-M16	M16 x 1.5	8
9512-8-M22	M22 x 1.5	8
9512-10-M12	M12 x 1.5	10
9512-10-M16	M16 x 1.5	10
9512-10-M18	M18 x 1.5	10
9512-10-M22	M22 x 1.5	10
9512-10/7-M12	M12 x 1.5	10/7
9512-10/7-M16	M16 x 1.5	10/7
9512-10/7-M22	M22 x 1.5	10/7
9512-12-M12	M12 x 1.5	12
9512-12-M14	M14 x 1.5	12
9512-12-M16	M16 x 1.5	12
9512-12-M22	M22 x 1.5	12
9512-15-M16	M16 x 1.5	15
9512-15-M22	M22 x 1.5	15
9512-15/11-M16	M16 x 1.5	15/11
9512-16-M22	M22 x 1.5	16
9512-16/12-M16	M16 x 1.5	16/12
9512-16/12-M22	M22 x 1.5	16/12
9512-18-M22	M22 x 1.5	18

Tech Sheet 20453



Male, NPT

0322	Thread	OD mm
9510-6-02	1/8"	6
9510-05-02	1/8"	8



Female, Metric

0322	Thread	OD mm
9463-6-M10	M10 x 1	6
9463-6-M16	M16 x 1.5	6
9463-8-M10	M10 x 1	8

Elbow Adaptors



Male, Metric

0322	Thread	OD mm
9502-6-M10	M10 x 1	6
9502-6-M12	M12 x 1.5	6
9502-6-M16	M16 x 1.5	6
9502-6-M22	M22 x 1.5	6
9502-8-M10	M10 x 1	8
9502-8-M12	M12 x 1.5	8
9502-8-M14	M14 x 1.5	8
9502-8-M16	M16 x 1.5	8
9502-8-M22	M22 x 1.5	8
9502-10-M12	M12 x 1.5	10
9502-10-M16	M16 x 1.5	10
9502-10-M22	M22 x 1.5	10
9502-10/7-M12	M12 x 1.5	10/7
9502-10/7-M16	M16 x 1.5	10/7
9502-10/7-M22	M22 x 1.5	10/7
9502-12-M12	M12 x 1.5	12
9502-12-M16	M16 x 1.5	12
9502-12-M22	M22 x 1.5	12
9502-15-M16	M16 x 1.5	15
9502-15-M22	M22 x 1.5	15
9502-16-M22	M22 x 1.5	16
9502-16/12-M16	M16 x 1.5	16/12
9502-16/12-M22	M22 x 1.5	16/12
9502-18-M22	M22 x 1.5	18

Tech Sheet 20453



Double Push-in, Male, Metric

0322	Thread	OD mm
9402-12-M16	M16 x 1.5	12
9402-12-M22	M22 x 1.5	12

Tech Sheet 20453



Male, NPT

0322	Thread	OD mm
9500-6-02	1/8"	6
9500-05-02	1/8"	8

Tech Sheet 20453

AIR BRAKE THREADED FITTINGS C-TRUCK 9000 SERIES

Tee Adaptors



Male Branch, Metric

0322	Thread	OD mm
9412-6-M10	M10 x 1	6
9412-6-M12	M12 x 1.5	6
9412-6-M16	M16 x 1.5	6
9412-8-M12	M12 x 1.5	8
9412-8-M16	M16 x 1.5	8
9412-8-M22	M22 x 1.5	8
9412-10-M12	M12 x 1.5	10
9412-10-M16	M16 x 1.5	10
9412-10-M22	M22 x 1.5	10
9412-10/7-M12	M12 x 1.5	10/7
9412-10/7-M16	M16 x 1.5	10/7
9412-10/7-M22	M22 x 1.5	10/7
9412-12-M12	M12 x 1.5	12
9412-12-M16	M16 x 1.5	12
9412-12-M22	M22 x 1.5	12
9412-15-M16	M16 x 1.5	15
9412-15-M22	M22 x 1.5	15
9412-15/11-M16	M16 x 1.5	15/11
9412-15/11-M22	M22 x 1.5	15/11

Tech Sheet 20453



Male Branch, NPT

0322	Thread	OD mm
9410-6-02	1/8"	6
9410-05-02	1/8"	8

Tech Sheet 20453



Male Run, Metric

0322	Thread	OD mm
9422-6-M10	M10 x 1	6
9422-6-M12	M12 x 1.5	6
9422-6-M16	M16 x 1.5	6
9422-8-M12	M12 x 1.5	8
9422-8-M16	M16 x 1.5	8
9422-8-M22	M22 x 1.5	8
9422-10-M16	M16 x 1.5	10
9422-10-M22	M22 x 1.5	10
9422-12-M12	M12 x 1.5	12
9422-12-M16	M16 x 1.5	12
9422-12-M22	M22 x 1.5	12
9422-15-M16	M16 x 1.5	15
9422-15-M22	M22 x 1.5	15

Tech Sheet 20453



Male Run, NPT

0322	Thread	OD mm
9420-6-02	1/8"	6
9420-05-02	1/8"	8

Tech Sheet 20453

Y Piece Adaptors



Male, Metric

0322	Thread	OD mm
9450-8-M16	M16 x 1.5	8
9450-12-M16	M16 x 1.5	12
9450-12-M22	M22 x 1.5	12

Tech Sheet 20453

Straight Couplings



Tube x Tube

0322	OD mm
9580-6	6
9580-8	8
9580-10	10
9580-12	12
9580-15/11	15/11
9580-16/12	16/12
9580-18/14	18/14

Tech Sheet 20453

Elbows



Tube x Tube

0322	OD mm
9550-6	6
9550-8	8
9550-10	10
9550-12	12

Tech Sheet 20453

Tees



Equal, Tube x Tube

0322	OD mm
9540-6	6
9540-8	8
9540-10	10
9540-12	12
9540-15/11	15/11

Tech Sheet 20453



Branch Unequal, Tube x Tube

0322	OD mm	OD mm
9540-8-8-6	8	6
9540-12-12-8	12	8

Tech Sheet 20453

Bulkhead Couplings



Male, Metric

0322	Thread	OD mm
9590-8-M18	M18 x 1.5	8
9590-8-M18-S01	M18 x 1.5	8
9590-12-M18	M18 x 1.5	12
9590-12-M18-S01	M18 x 1.5	12

Tech Sheet 20453

Bulkhead Couplings



Female, Metric

0322	Thread	OD mm
9592-8-8-M18	M18 x 1.5	8
9592-12-8-M18	M18 x 1.5	12

Tech Sheet 20453

AIR BRAKE THREADED FITTINGS C-TRUCK 9000 SERIES

Tees

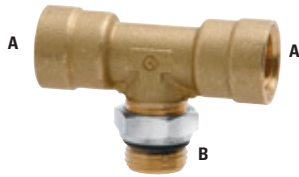

Male x Female Branch, Metric

0322	Thread A	Thread B
D2062-M16XM12	M16 x 1.5	M12 x 1.5
D2062-M16XM16	M16 x 1.5	M16 x 1.5
D2062-M16XM22	M22 x 1.5	M16 x 1.5
D2062-M22XM22	M22 x 1.5	M22 x 1.5

Tech Sheet 20453

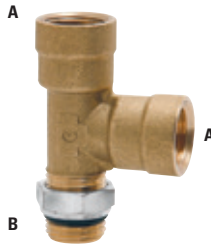

Male x Female Run, Metric

0322	Thread A	Thread B
D2072-M16XM12	M16 x 1.5	M12 x 1.5
D2072-M16XM16	M16 x 1.5	M16 x 1.5
D2072-M16XM22	M22 x 1.5	M16 x 1.5
D2072-M22XM22	M22 x 1.5	M22 x 1.5

Tech Sheet 20453



Equal Female, Metric

0322	Thread
D2003-M16	M16 x 1.5
D2003-M22	M22 x 1.5

Tech Sheet 20453

Equal Female, Metric (Mountable)

0322	Thread
D2003-M16-S01	M16 x 1.5

Tech Sheet 20453



Double Female, Metric

0322	Thread
D3043-M16-2D-S01	M16 x 1.5

Tech Sheet 20453

Bulkheads

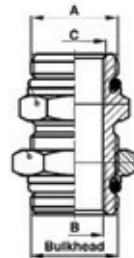

Female, Metric

0322	Thread A	Thread B	Thread C	Bulkhead
D2512-M22XM16	M16	M16	M10	M22
D2502-M22XM22	M22	M16	M16	M22

Tech Sheet 20453

Elbows



Male x Female, Metric

0322	Thread A	Thread B
D2022-M16XM16	M16 x 1.5	M16 x 1.5
D2022-M16XM22	M22 x 1.5	M16 x 1.5
D2022-M22XM22	M22 x 1.5	M22 x 1.5

Tech Sheet 20453

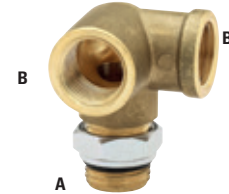

Male x Female, 2 Way Elbow, Metric

0322	Thread A	Thread B
D2077-M16-S01	M16 x 1.5	M16 x 1.5
D2077-M16M22S01	M16 x 1.5	M22 x 1.5

Tech Sheet 20453

Cross



Male x Female, Metric

0322	Thread
D2032-M16	M16 x 1.5

Tech Sheet 20453

For Air Brake Tubing
see page 910



AIR BRAKE ACCESSORIES C-TRUCK 9000 SERIES

Hosetail Adaptors



Male, Metric

0322	Thread	OD mm	Length A mm
D2602-10-M16-L30	M16 x 1.5	11	30
D2602-12-M16X1.5	M16 x 1.5	12.5	20
D2602-11.5M16L35	M16 x 1.5	12.5	35

Tech Sheet 20453

Release Tools



Metric

0322	To Suit mm
DRK 6	6
DRK 8	8
DRK 10	10
DRK 12	12
DRK 15	15
DRK 16	16
DRK 18	18

Tech Sheet 20453

Plugs



Male, Metric

0322	Thread
D2612-M12X1.5	M12 x 1.5
D2612-M16X1.5	M16 x 1.5
D2612-M22X1.5	M22 x 1.5

Tech Sheet 20453

Test Point Valve



Male, Metric

0322	Thread	Thread
VPC-M16-M16	M16 x 1.5	M16 x 1.5
VPC-M22-M16	M22 x 1.5	M16 x 1.5

Tech Sheet 20453

Inflation alve



Male x Female, Metric

0322	Thread
V604-M22-S01	M22 x 1.5

Tech Sheet 20453

Drain Valve



Male, Metric

0322	Thread
VDC-M22-S01	M22 x 1.5

Tech Sheet 20453

Push-in Connector



Male Metric Fittings Mod D6512

0322	Thread	OD mm
D6512-4-M10	M10 x 1	4

Tech Sheet 20453



For PPE
see pages 1750-1760

Hose & Tubing

Thermoplastic tubing, hoses and assemblies for industrial and mobile applications.



- Polyurethane Tube
- Polyurethane Recoil Hoses
- Polyurethane Assemblies
- Nylon Tubing
- Nylon Recoil Hoses
- Tube Cutters



FT PRO[®]

new
product

Crystal Blue

FT Pro tubing is the engineered solution for pneumatic applications requiring excellence as standard.





Metric Polyurethane Ester Tube

Ester-based polyurethane tubing has outstanding characteristics compared with other pneumatic tubing. This tube is extremely flexible and offers excellent bend capabilities, making it ideal for pneumatic control or robotic systems. It is also resistant to many chemicals, gases and oils, as well as having excellent abrasion resistance.

- ✓ **Ideal for use with push-in fittings, compression fittings, quick-fit fittings and hose tail fittings.**
- ✗ **Not suitable for use with water or in high humidity environments.**

Specifications

**Medium**

Compressed air and industrial fluids

**Working Pressure**

Vacuum to 12 bar

**Working Temperature**

-20°C to +70°C

**Component Materials**

Polyurethane ester

Regulations

Industrial

DI: 2002/95/EC (RoHS), 2011/65/EC

DI: 97/23/EC (PED)

RG: 1907/2006 (REACH)



Metric Polyurethane Ester Tube



Part Number Colour Codes

N	Black	G	Green
B	Blue		Transparent
R	Red	CB	Crystal Blue
Y	Yellow		



Metric, 25 Metre Coils

5030	OD mm	ID mm	Colour	Max Pressure PSI	Max Pressure Bar
PU03/020B	3	2	■	150	10
PU03/020CB	3	2	■	150	10
PU04/025N	4	2.5	■	190	13
PU04/025B	4	2.5	■	190	13
PU04/025CB	4	2.5	■	190	13
PU04/025R	4	2.5	■	190	13
PU04/025Y	4	2.5	■	190	13
PU04/025G	4	2.5	■	190	13
PU04/025	4	2.5	□	190	13
PU05/030N	5	3	■	160	11
PU05/030B	5	3	■	160	11
PU05/030CB	5	3	■	160	11
PU06/040N	6	4	■	155	11
PU06/040B	6	4	■	155	11
PU06/040CB	6	4	■	155	11
PU06/040R	6	4	■	155	11
PU06/040Y	6	4	■	155	11
PU06/040G	6	4	■	155	11
PU06/040	6	4	□	155	11
PU08/055N	8	5.5	■	150	10
PU08/055B	8	5.5	■	150	10
PU08/055CB	8	5.5	■	150	10
PU08/055R	8	5.5	■	150	10
PU08/055Y	8	5.5	■	150	10
PU08/055G	8	5.5	■	150	10
PU08/055	8	5.5	□	150	10
PU08/060N	8	6	■	120	8

5030	OD mm	ID mm	Colour	Max Pressure PSI	Max Pressure Bar
PU08/060B	8	6	■	120	8
PU08/060CB	8	6	■	120	8
PU08/060R	8	6	■	120	8
PU08/060Y	8	6	■	120	8
PU08/060G	8	6	■	120	8
PU08/060	8	6	□	120	8
PU10/065N	10	6.5	■	125	9
PU10/065B	10	6.5	■	125	9
PU10/065CB	10	6.5	■	125	9
PU10/065R	10	6.5	■	125	9
PU10/065Y	10	6.5	■	125	9
PU10/065G	10	6.5	■	125	9
PU10/065	10	6.5	□	125	9
PU10/080N	10	8	■	120	8
PU10/080B	10	8	■	120	8
PU10/080CB	10	8	■	120	8
PU10/080	10	8	□	120	8
PU12/080N	12	8	■	120	8
PU12/080B	12	8	■	120	8
PU12/080CB	12	8	■	120	8
PU12/080R	12	8	■	120	8
PU12/080Y	12	8	■	120	8
PU12/080G	12	8	■	120	8
PU12/080	12	8	□	120	8
PU16/110B	16	11	■	100	7
PU16/110CB	16	11	■	100	7

Tech Sheet 3131



REACH ✓

RoHS

Polyurethane Tube FT PRO®

Metric Polyurethane Ester Tube

Ester based polyurethane tubing has outstanding characteristics compared with other pneumatic tubing.

Part Number Colour Codes

N Black **B** Blue **R** Red **Y** Yellow **G** Green Transparent **CB** Crystal Blue

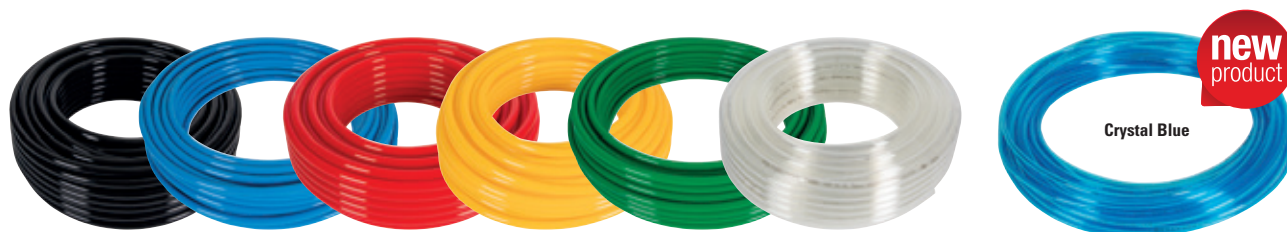

Metric, 100 Metre Coils

5030	OD mm	ID mm	Colour	Max Pressure PSI	Max Pressure Bar
PU04/025N-100	4	2.5	Black	190	13
PU04/025B-100	4	2.5	Blue	190	13
PU04/025CB-100	4	2.5	Crystal Blue	190	13
PU04/025R-100	4	2.5	Red	190	13
PU04/025Y-100	4	2.5	Yellow	190	13
PU04/025G-100	4	2.5	Green	190	13
PU04/025-100	4	2.5	Transparent	190	13
PU06/040N-100	6	4	Black	155	11
PU06/040B-100	6	4	Blue	155	11
PU06/040CB-100	6	4	Crystal Blue	155	11
PU06/040R-100	6	4	Red	155	11
PU06/040Y-100	6	4	Yellow	155	11
PU06/040G-100	6	4	Green	155	11
PU06/040-100	6	4	Transparent	155	11
PU08/055N-100	8	5.5	Black	150	10
PU08/055B-100	8	5.5	Blue	150	10
PU08/055CB-100	8	5.5	Crystal Blue	150	10
PU08/055R-100	8	5.5	Red	150	10
PU08/055Y-100	8	5.5	Yellow	150	10
PU08/055G-100	8	5.5	Green	150	10
PU08/055-100	8	5.5	Transparent	150	10
PU08/060N-100	8	6	Black	120	8
PU08/060B-100	8	6	Blue	120	8

5030	OD mm	ID mm	Colour	Max Pressure PSI	Max Pressure Bar
PU08/060CB-100	8	6	Crystal Blue	120	8
PU08/060R-100	8	6	Red	120	8
PU08/060Y-100	8	6	Yellow	120	8
PU08/060G-100	8	6	Green	120	8
PU08/060-100	8	6	Transparent	120	8
PU10/065N-100	10	6.5	Black	125	9
PU10/065B-100	10	6.5	Blue	125	9
PU10/065CB-100	10	6.5	Crystal Blue	125	9
PU10/065R-100	10	6.5	Red	125	9
PU10/065Y-100	10	6.5	Yellow	125	9
PU10/065G-100	10	6.5	Green	125	9
PU10/065-100	10	6.5	Transparent	125	9
PU10/080N-100	10	8	Black	120	8
PU10/080B-100	10	8	Blue	120	8
PU10/080CB-100	10	8	Crystal Blue	120	8
PU10/080-100	10	8	Transparent	120	8
PU12/080N-100	12	8	Black	120	8
PU12/080B-100	12	8	Blue	120	8
PU12/080CB-100	12	8	Crystal Blue	120	8
PU12/080R-100	12	8	Red	120	8
PU12/080G-100	12	8	Green	120	8
PU12/080-100	12	8	Transparent	120	8

Tech Sheet 3131

Polyurethane Recoil Twin Hose



Working Temperature

-20°C to +70°C



Red/Yellow

0306	OD mm	ID mm	Working Length Metres
TWIN80505RY	8	5	2.5
TWIN10656RY	10	6.5	3
TWIN12806RY	12	8	3

Tech Sheet 3133

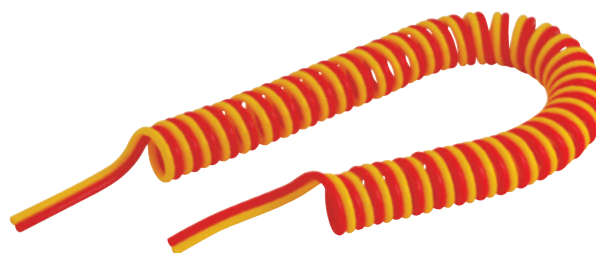

Metric Polyurethane Ether Tube



Working Temperature
-40°C to +70°C

Ether based tube has a greater durability to water and high humidity environments.

PUET air line tubing is made from 95A shore durometer, ether-based polyurethane and is an excellent choice for compressed air systems.

- Kink and abrasion resistant.
- Resistant to chemicals, water, fuel and oil.
- Outstanding flexibility and memory.
- Safety factor of 3 to 1
- Vacuum rating 28" Hg.

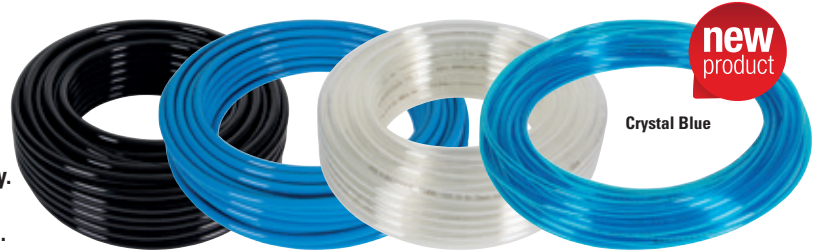

Crystal Blue

Metric, 25 Metre Coils

5030	OD mm	ID mm	Colour	Max Pressure PSI	Max Pressure Bar
PUET04/025N-25	4	2.5	■	156	11
PUET04/025B-25	4	2.5	■	156	11
PUET04/025CB-25	4	2.5	■	156	11
PUET04/025-25	4	2.5	□	156	11
PUET05/030N-25	5	3	■	171	12
PUET05/030B-25	5	3	■	171	12
PUET05/030CB-25	5	3	■	171	12
PUET05/030-25	5	3	□	171	12
PUET06/040N-25	6	4	■	142	10
PUET06/040B-25	6	4	■	142	10
PUET06/040CB-25	6	4	■	142	10
PUET06/040-25	6	4	□	142	10
PUET08/055N-25	8	5.5	■	114	8
PUET08/055B-25	8	5.5	■	114	8
PUET08/055CB-25	8	5.5	■	114	8
PUET08/055-25	8	5.5	□	114	8
PUET10/070N-25	10	7	■	114	8
PUET10/070B-25	10	7	■	114	8
PUET10/070CB-25	10	7	■	114	8
PUET10/070-25	10	7	□	114	8
PUET12/080N-25	12	8	■	128	9
PUET12/080B-25	12	8	■	128	9
PUET12/080CB-25	12	8	■	128	9
PUET12/080-25	12	8	□	128	9

Tech Sheet 3132

Metric, 100 Metre Coils

5030	OD mm	ID mm	Colour	Max Pressure PSI	Max Pressure Bar
PUET04/025N-100	4	2.5	■	156	11
PUET04/025B-100	4	2.5	■	156	11
PUET04/025CB-100	4	2.5	■	156	11
PUET04/025-100	4	2.5	□	156	11
PUET06/040N-100	6	4	■	142	10
PUET06/040B-100	6	4	■	142	10
PUET06/040CB-100	6	4	■	142	10
PUET06/040-100	6	4	□	142	10
PUET08/055N-100	8	5.5	■	114	8
PUET08/055B-100	8	5.5	■	114	8
PUET08/055CB-100	8	5.5	■	114	8
PUET08/055-100	8	5.5	□	114	8
PUET10/070N-100	10	7	■	114	8
PUET10/070B-100	10	7	■	114	8
PUET10/070CB-100	10	7	■	114	8
PUET10/070-100	10	7	□	114	8
PUET12/080N-100	12	8	■	128	9
PUET12/080B-100	12	8	■	128	9
PUET12/080CB-100	12	8	■	128	9
PUET12/080-100	12	8	□	128	9

Tech Sheet 3132

Blow Guns & Polyurethane Coil Assemblies, Red

1/4" BSPT

5030	OD mm	ID mm	Working Length Metres	Blow Gun Type
2027-3967	6	4	2	ASG-1
2027-3975	6	4	4	ASG-1
2027-4007	6	4	2	BG5
2027-4015	6	4	4	BG5
2027-4023	10	6.5	2	ASG-1
2025-2763	10	6.5	4	ASG-1
2027-4049	10	6.5	6	ASG-1
2027-4056	10	6.5	2	BG5
2027-4064	10	6.5	4	BG5
2027-4072	10	6.5	6	BG5

Tech Sheet 3133

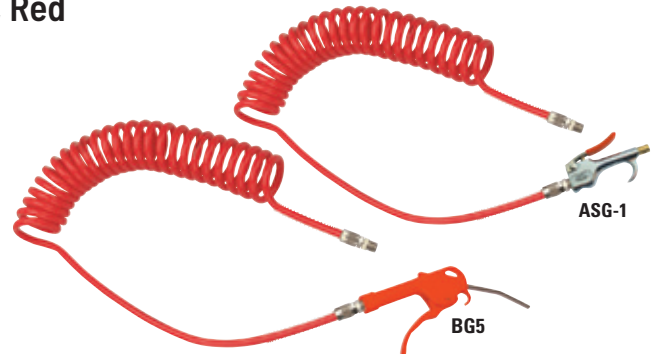



REACH ✓

RoHS

Polyurethane Recoil Hoses FT PRO®

Metric Polyurethane Coil Assemblies

Also available in

B Blue **R** Red **Y** Yellow



Brass Nickel Plated Swivel, BSPT with Spring Guards

5030	OD mm	ID mm	Working Length Metres	Thread	Colour
2196-4229	6	4	2	1/4"	■
2196-4230	6	4	4	1/4"	■
2196-4231	6	4	6	1/4"	■
2196-4232	6	4	8	1/4"	■
2196-4233	6	4	10	1/4"	■
2196-4234	8	5	2	1/4"	■
2196-4235	8	5	4	1/4"	■
2196-4236	8	5	6	1/4"	■
2196-4237	8	5	8	1/4"	■
2196-4238	8	5	10	1/4"	■
2196-4239	8	5	12	1/4"	■
2196-4240	10	6.5	2	1/4"	■
2196-4241	10	6.5	4	1/4"	■
2196-4242	10	6.5	6	1/4"	■
2196-4243	10	6.5	8	1/4"	■
2196-4244	10	6.5	10	1/4"	■
2196-4245	10	6.5	12	1/4"	■
2196-4246	12	8	2	3/8"	■
2196-4247	12	8	4	3/8"	■
2196-4248	12	8	6	3/8"	■
2196-4249	12	8	8	3/8"	■
2196-4250	12	8	10	3/8"	■
2196-4251	12	8	12	3/8"	■
2196-4252	6	4	2	1/4"	■
2196-4253	6	4	4	1/4"	■
2196-4254	6	4	6	1/4"	■
2196-4255	6	4	8	1/4"	■
2196-4256	6	4	10	1/4"	■
2196-4257	8	5	2	1/4"	■
2196-4258	8	5	4	1/4"	■
2196-4259	8	5	6	1/4"	■
2196-4260	8	5	8	1/4"	■
2196-4261	8	5	10	1/4"	■
2196-4262	8	5	12	1/4"	■
2196-4263	10	6.5	2	1/4"	■
2196-4264	10	6.5	4	1/4"	■
2196-4265	10	6.5	6	1/4"	■
2196-4266	10	6.5	8	1/4"	■
2196-4267	10	6.5	10	1/4"	■
2196-4268	10	6.5	12	1/4"	■
2196-4269	12	8	2	3/8"	■
2196-4270	12	8	4	3/8"	■
2196-4271	12	8	6	3/8"	■
2196-4272	12	8	8	3/8"	■
2196-4273	12	8	10	3/8"	■

5030	OD mm	ID mm	Working Length Metres	Thread	Colour
2196-4275	6	4	2	1/4"	■
2196-4276	6	4	4	1/4"	■
2196-4277	6	4	6	1/4"	■
2196-4278	6	4	8	1/4"	■
2196-4279	6	4	10	1/4"	■
2196-4280	8	5	2	1/4"	■
2196-4281	8	5	4	1/4"	■
2196-4282	8	5	6	1/4"	■
2196-4283	8	5	8	1/4"	■
2196-4284	8	5	10	1/4"	■
2196-4285	8	5	12	1/4"	■
2196-4286	10	6.5	2	1/4"	■
2196-4287	10	6.5	4	1/4"	■
2196-4288	10	6.5	6	1/4"	■
2196-4289	10	6.5	8	1/4"	■
2196-4290	10	6.5	10	1/4"	■
2196-4291	10	6.5	12	1/4"	■
2196-4292	12	8	2	3/8"	■
2196-4293	12	8	4	3/8"	■
2196-4294	12	8	6	3/8"	■
2196-4295	12	8	8	3/8"	■
2196-4296	12	8	10	3/8"	■
2196-4297	12	8	12	3/8"	■
2196-4298	6	4	2	1/4"	■
2196-4299	6	4	4	1/4"	■
2196-4300	6	4	6	1/4"	■
2196-4301	6	4	8	1/4"	■
2196-4302	6	4	10	1/4"	■
2196-4303	8	5	2	1/4"	■
2196-4304	8	5	4	1/4"	■
2196-4305	8	5	6	1/4"	■
2196-4306	8	5	8	1/4"	■
2196-4307	8	5	10	1/4"	■
2196-4308	8	5	12	1/4"	■
2196-4309	10	6.5	2	1/4"	■
2196-4310	10	6.5	4	1/4"	■
2196-4311	10	6.5	6	1/4"	■
2196-4312	10	6.5	8	1/4"	■
2196-4313	10	6.5	10	1/4"	■
2196-4314	10	6.5	12	1/4"	■
2196-4315	12	8	2	3/8"	■
2196-4316	12	8	4	3/8"	■
2196-4317	12	8	6	3/8"	■
2196-4318	12	8	8	3/8"	■
2196-4319	12	8	10	3/8"	■
2196-4320	12	8	12	3/8"	■

Swivel Fitting for Polyurethane Tube & Flexi-Braid Polyurethane Braided Hose

Other fittings can be used with "Flexi-Braid" Hose, such as brass hose-tails (see page 1141) stainless steel hose tails (see page 1311) or nylon hose tails (see page 1150).



Brass Fitting BSPT

5030	To Suit Tube Size mm	Thread
PF0406-14	4 x 6	1/4"
PF0508-14	5 x 8	1/4"
PF0610-14	6.5 x 10	1/4"
PF0812-14	8 x 12	1/4"
PF0812-38	8 x 12	3/8"

Tech Sheet 20350

Brass Fitting BSPT, Nickel Plated with Spring Guards



5030	To Suit Tube Size mm	Thread
PF0406-14-NG	4 x 6	1/4"
PF0508-14-NG	5 x 8	1/4"
PF0610-14-NG	6.5 x 10	1/4"
PF0812-14-NG	8 x 12	1/4"
PF0812-38-NG	8 x 12	3/8"

Tech Sheet 20350

Metric Poly Coil Assemblies

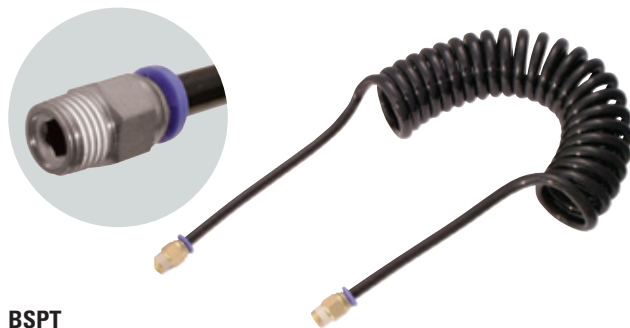

BSPT

5030	OD mm	Working Length Mtrs	Thread
PUC4/1-18	4	1	1/8"
PUC4/1-14	4	1	1/4"
PUC4/2-18	4	2	1/8"
PUC4/2-14	4	2	1/4"
PUC6/1-18	6	1	1/8"
PUC6/1-14	6	1	1/4"
PUC6/2-18	6	2	1/8"
PUC6/2-14	6	2	1/4"
PUC6/3-18	6	3	1/8"
PUC6/3-14	6	3	1/4"
PUC8/2-14	8	2	1/4"
PUC8/2-38	8	2	3/8"
PUC8/3-14	8	3	1/4"
PUC8/5-14	8	5	1/4"

Tech Sheet 3135

Polyurethane Coil Type PUC

Coil hose polyurethane self-storing hose was developed to eliminate the two most common limitations of nylon self storing hoses; kinking and abrasion resistance. Lightweight yet extremely durable, polyurethane coil hose is ideal for use in tough work areas or highly mobile applications. This extremely flexible material which resists kinking and is

impervious to abrasions and oils, is ideally suited for production line air tools; instrumentation; robotics; and many more industrial applications. The superior elasticity characteristics and very small bend radius make it ideal for use in confined spaces.

Supplied without fittings, but ideal for use with push-in, hose tail or quick-fit fittings.



Working Temperature
-20°C to +60°C

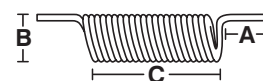

CB Crystal Blue

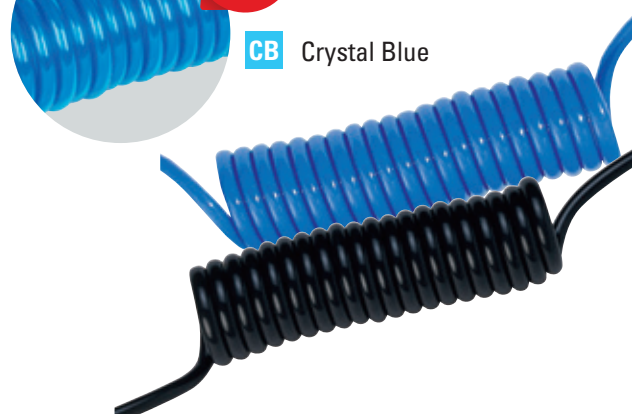

5030	OD mm	ID mm	Length A mm	Length B mm	Length C mm	Working Length Mtrs	Colour
PUC4/1	4	2.5	80	26	60	1	■
PUC4/2	4	2.5	80	26	120	2	■
PUC6/1	6	4	120	37	51	1	■
PUC6/2	6	4	120	37	120	2	■
PUC6/3	6	4	120	37	185	3	■
PUC8/2	8	5	150	47	140	2	■
PUC8/3	8	5	150	47	210	3	■
PUC8/5	8	5	150	47	345	5	■
PUC4/1B	4	2.5	80	26	60	1	■
PUC4/2B	4	2.5	80	26	120	2	■
PUC6/1B	6	4	120	37	51	1	■
PUC6/2B	6	4	120	37	120	2	■
PUC6/3B	6	4	120	37	185	3	■
PUC8/2B	8	5	150	47	140	2	■
PUC8/3B	8	5	150	47	210	3	■
PUC8/5B	8	5	150	47	345	5	■
PUC4/1CB	4	2.5	80	26	60	1	■
PUC4/2CB	4	2.5	80	26	120	2	■
PUC6/1CB	6	4	120	37	51	1	■
PUC6/2CB	6	4	120	37	120	2	■
PUC6/3CB	6	4	120	37	186	3	■
PUC8/2CB	8	5	150	47	140	2	■
PUC8/3CB	8	5	150	47	210	3	■
PUC8/5CB	8	5	150	47	345	5	■

Tech Sheet 3134

Imperial Polyurethane Tube



25 Metre Coils, Black

5030	OD	ID	ID mm
2021-5265	1/8"	1/6"	2
2021-5273	1/4"	1/8"	4
2021-5281	5/16"	3/16"	5
2021-5299	3/8"	1/4"	6.5



100 Metre Coils, Black

5030	OD	ID	ID mm
2021-5224	1/8"	1/6"	2
2021-5232	1/4"	1/8"	4
2021-5240	5/16"	3/16"	5
2021-5257	3/8"	1/4"	6.5

'Flexi-Braid' Tubing

"Flexi-Braid" inner-braided polyurethane hose offers an excellent alternative to much bulkier rubber and plastic hoses. Extremely lightweight and tough, it is ideal for either outdoor contractor use or indoor industrial use. "Flexi-Braid" retains its flexibility even in cold environments. Unlike other hoses that are made up of a separate core, braiding and cover, "Flexi-Braid" is extracted complete as a braided hose.

This integral piece construction eliminates the possibility of having the various layers separate due to constant expansion and contraction during pulsating operations, such as with staple or nail guns.

Flexi-Braid Advantages:

- Extremely flexible with a lively rubber like feel making it easier to rewind and handle.
- Broad temperature range (-20°C to +80°C) and retains its flexibility even in sub-zero temperatures.
- Highly resistant to lubricating oils and greases that can damage PVC.
- UV stabilised for larger out door service.
- Extremely tough, it is the most abrasion resistant tube available.
- High flexural strength, it withstands the rigors of repeated flexing and tight bends..

Flexi-Braid Polyurethane Recoils

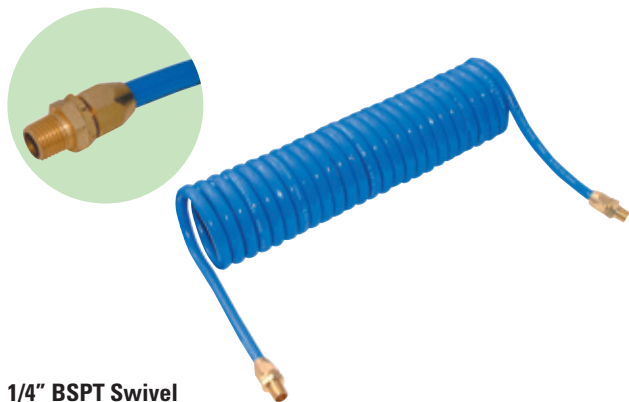

1/4" BSPT Swivel

5030	OD mm	ID mm	Working Length Metres
IBR10-50	10	6.5	5
IBR10-75	10	6.5	7.5
IBR12-50	12	8	5
IBR12-75	12	8	7.5

Tech Sheet 20345

Flexi-Braid Polyurethane Braided Hose

Working Temperature:
-20°C to +80°C

Maximum Working Pressure:
15 bar (200 psi)



Blue, 25 Metre Coils

5030	OD mm	ID mm
BPU065/100B	10	6.5
BPU080/120B	12	8
BPU100/145B	14.5	10

Tech Sheet 20346

POLYURETHANE ANTI-SPATTER TUBE & HOSE



Polyurethane Anti-spatter Tube

This PVC/Polyurethane, alloy tubing has been developed by taking 98A durometer polyurethane as the inner tube and jacketing it with a specially formulated flame retardant cover.

The jacket protects the tubing from incidental contact with weld spatter.

Features:

- UL-94 (V-0) Fire Resistance.
- High abrasion resistance.
- Non-Marking Cover.
- Good flexibility over a wide temperature range.
- Excellent fitting retention at elevated temperatures.

Temperature Range:
-40°C to +70°C

Applications:

- Transfer of Air & Water.
- Induction welding tubing lines.
- Transfer of deionised water.
- Robotic & Pneumatic Air Lines.
- Automotive assembly lines.

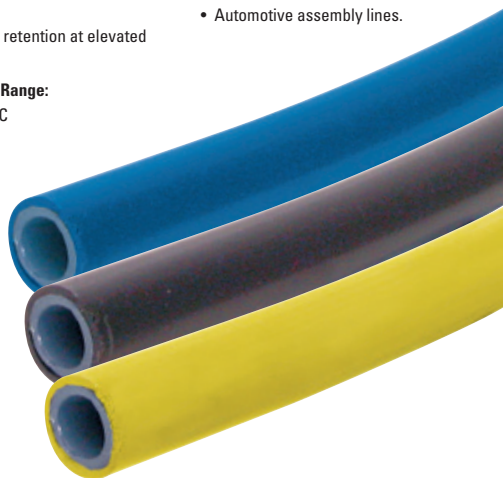

Anti-spatter Tube, 50 Metre Coils

0306	OD mm	ID mm	Colour	Max Pressure PSI	Max Pressure Bar	Bend Radius mm
S604050MBU	6	4	Blue	159	11	20
S604050MGY	6	4	Grey	159	11	20
S604050MY	6	4	Yellow	159	11	20
S805050MBU	8	5	Blue	188	13	30
S805050MGY	8	5	Grey	188	13	30
S805050MY	8	5	Yellow	188	13	30
S128050MBU	12	8	Blue	145	10	45
S128050MGY	12	8	Grey	145	10	45
S128050MY	12	8	Yellow	145	10	45

Tech Sheet 20343

Polyurethane Anti-spatter Recoil Hose

Temperature Range:
-40°C to +70°C

Safety factor of 3 to 1.



Blue, Anti-spatter Recoil Hose, 4 Metre Coils, 1/4" BSPT

0306	OD mm	ID mm	Max Pressure PSI	Max Pressure Bar	Bend Radius mm
SC60404MBU	6	4	159	11	15
SC80504MBU	8	5	188	13	20
SC10654MBU	10	6.5	159	10	30

Tech Sheet 20344



For **Welding Sprays**
see page 1577

Tube & Hose Cutters



Nylon & Polyurethane Tube Cutter, 3mm-16mm

5100	Colour
KTC-1	Blue

Tech Sheet 3136



LBS-25



LBS-120



LBS-63N

5100	To Suit Tube OD mm
LBS-25	3 - 25
LBS-120	6 - 42
LBS-63N	6 - 63



Metal

5100	To Suit Tube OD mm
27000216	2 - 12
27000825	4 - 28

Spare Blades (Per Piece)

5100	To Suit
27010216	27000216
27010825	27000825



Replacement Blade



Heavy-duty

9057	Description
TCUT0001	Up to 20mm Tube
TCUT0101	Replacement Blade up to 20mm



Heavy-duty

1400	Description
JG-TSP	To Suit up to 22mm Pipe

Copper Tube Cutters



Standard Cutter

5100	To Suit OD mm
CTC1	3-28



Mini Cutter

5100	To Suit OD mm
CTC2	3-16

Automatic Tube Cutters

- Single action automatic tube cutting in tight locations.



5100	To Suit OD mm
88801	15
88802	22

Copper Tube Reamer



Internal/External Reamer for Tube

5070	To Suit OD mm
CTR1	3-36

TUBING

Crystal Clear Colour Tinted Polyether Polyurethane Tubing



25 Metre Rolls, Tinted Close Tolerance Flexible

1014	OD mm	ID mm	Colour
LE-1025U04R12	4	2.5	Green
LE-1025U04R13	4	2.5	Red
LE-1025U04R14	4	2.5	Blue
LE-1025U04R17	4	2.5	Orange
LE-1025U06R12	6	4	Green
LE-1025U06R13	6	4	Red
LE-1025U06R14	6	4	Blue
LE-1025U06R17	6	4	Orange
LE-1025U08R12	8	5.5	Green
LE-1025U08R13	8	5.5	Red
LE-1025U08R14	8	5.5	Blue
LE-1025U08R17	8	5.5	Orange
LE-1025U10R14	10	7	Blue
LE-1025U12R14	12	8	Blue

Tech Sheet 60547

100 Metre Rolls, Tinted Close Tolerance Flexible

1014	OD mm	ID mm	Colour
LE-1100U04R12	4	2.5	Green
LE-1100U04R13	4	2.5	Red
LE-1100U04R14	4	2.5	Blue
LE-1100U04R17	4	2.5	Orange
LE-1100U06R12	6	4	Green
LE-1100U06R13	6	4	Red
LE-1100U06R14	6	4	Blue
LE-1100U06R17	6	4	Orange
LE-1100U08R12	8	5.5	Green
LE-1100U08R13	8	5.5	Red
LE-1100U08R14	8	5.5	Blue
LE-1100U08R17	8	5.5	Orange
LE-1100U10R14	10	7	Blue
LE-1100U12R14	12	8	Blue

Tech Sheet 60547

Polyamide Fireproof High Resistance Tubing

° Working Temperature:
-40°C to +100°C

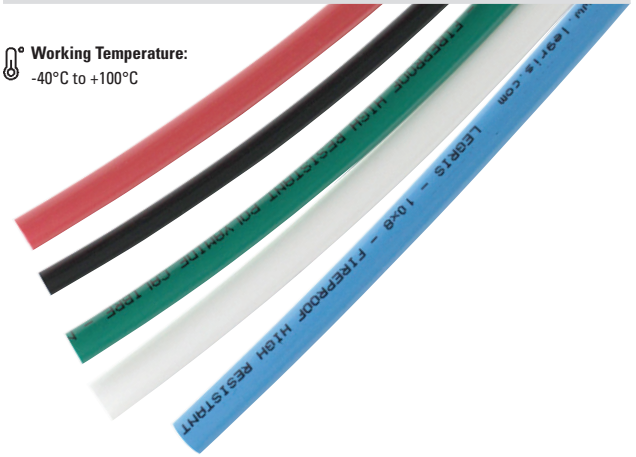

100 Metre Coils

1014	OD mm	ID mm	Colour
LE-1100P04R00	4	2	Natural
LE-1100P04R01	4	2	Black
LE-1100P04R04	4	2	Blue
LE-1100P06R00	6	4	Natural
LE-1100P06R01	6	4	Black
LE-1100P06R04	6	4	Blue
LE-1100P08R00	8	6	Natural
LE-1100P08R01	8	6	Black
LE-1100P08R04	8	6	Blue
LE-1100P10R00	10	8	Natural
LE-1100P10R01	10	8	Black
LE-1100P10R04	10	8	Blue
LE-1100P12R00	12	9	Natural
LE-1100P12R01	12	9	Black

Tech Sheet 10658

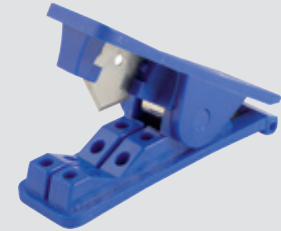

For Tube & Hose Cutters
see page 905

Advanced Polyethylene Tubing

- Suitable for a wide variety of uses in point of use water purification systems, industrial water treatment and drink dispense systems.
- Made from a high grade of polyethylene, the advanced PE tubing ensures the best balance between flexibility and pressure/temperature resistance.
- Resistant to a wide range of aggressive chemical agents.
- Available in nine colours.
- Black tubing is UV stabilized, making it resistant to direct ultraviolet sunlight and ideal for outdoor applications.
- Silicone free.

Working Temperature:
+34°F (1°C) to +203°F (95°C)



150 Metre Coils

1014	OD	ID	Colour
LE-1098Y56F00	1/4"	0.170"	Natural
LE-1098Y56F01	1/4"	0.170"	Black
LE-1098Y56F03	1/4"	0.170"	Red
LE-1098Y56F04	1/4"	0.170"	Blue
LE-1098Y60F00	3/8"	0.250"	Natural
LE-1098Y60F01	3/8"	0.250"	Black
LE-1098Y60F04	3/8"	0.250"	Blue

75 Metre Coils

1014	OD	ID	Colour
LE-1096Y62F00	1/2"	0.375"	Natural
LE-1096Y62F01	1/2"	0.375"	Black
LE-1096Y62F04	1/2"	0.375"	Blue

150 Metre Coils

1014	OD mm	ID mm	Colour
LE-1015Y06F00	6	4	Natural
LE-1015Y06F01	6	4	Black
LE-1015Y06F04	6	4	Blue
LE-1015Y08F00	8	5.75	Natural
LE-1015Y08F01	8	5.75	Black
LE-1015Y08F04	8	5.75	Blue
LE-1015Y10F00	10	7	Natural
LE-1015Y10F01	10	7	Black
LE-1015Y10F04	10	7	Blue

75 Metre Coils

1014	OD mm	ID mm	Colour
LE-1075Y12F00	4	2.5	Natural
LE-1075Y12F01	4	2.5	Black
LE-1075Y12F04	4	2.5	Blue



For **Parker Legris Fittings**
see pages **800-803**

TUBING

Polyether Polyurethane Tubing

The high flexibility of Legris flexible polyurethane tubing allows compact cabling where a small bend radius is required.

Legris flexible polyurethane tubing has a shore hardness 52°C and conforms to NFE 49.101 standard.

Polyether polyurethane tubing, for excellent resistance to humidity and bacteriological aggressions.

Polyester polyurethane available on request.



25 Metre Rolls, Close Tolerance Flexible

1014	OD mm	ID mm	Colour	Max Pressure PSI	Max Pressure Bar
LE-1025U04R01	4	2.5	Black	145	10
LE-1025U04R04	4	2.5	Blue	145	10
LE-1025U04R08	4	2.5	Clear	145	10
LE-1025U05R08	5	3	Clear	160	11
LE-1025U06R01	6	4	Black	130	9
LE-1025U06R04	6	4	Blue	130	9
LE-1025U06R08	6	4	Clear	130	9
LE-1025U08R01	8	5.5	Black	116	8
LE-1025U08R04	8	5.5	Blue	116	8
LE-1025U08R08	8	5.5	Clear	116	8
LE-1025U10R01	10	7	Black	116	8
LE-1025U10R04	10	7	Blue	116	8
LE-1025U10R08	10	7	Clear	116	8
LE-1025U12R01	12	8	Black	130	9
LE-1025U12R04	12	8	Blue	130	9
LE-1025U12R08	12	8	Clear	130	9
LE-1025U14R0495	14	9.5	Blue	130	9
LE-1025U14R0895	14	9.5	Clear	130	9

Polyurethane Twin Tubing

- Twin tubing maintains the smooth surface of both tubes when separated and keeps the characteristics of their dimensions.
- Swift and easy assembly.
- Compactness of circuitry.
- Differentiation of circuits, via two colours.



25 Metre Coils

1012	OD mm	ID mm	Colour
LE-1420U04 11	4	2.5	Black/Black
LE-1420U04 44	4	2.5	Blue/Blue
LE-1420U04 41	4	2.5	Black/Blue
LE-1420U06 11	6	4	Black/Black
LE-1420U06 44	6	4	Blue/Blue
LE-1420U06 41	6	4	Black/Blue
LE-1420U08 41	8	5.5	Black/Blue

Anti-spark Tubing

- Anti-spark tubing is suitable for installations submitted to aggressive environments and provides resistance to spark projections. It is designed with a PVC sheath and semi-rigid nylon tubing and conforms to UL94V-0 standard.
- A special mark on the tube indicates the length to be stripped back to reach the shoulder of the fitting.



25 Metre Coils

1012	OD mm	ID mm	Bend Radius mm	Colour
LE-1025P06V01	6	4	20	Black
LE-1025P06V04	6	4	20	Blue
LE-1025P08V01	8	6	25	Black
LE-1025P08V04	8	6	25	Blue
LE-1025P10V01	10	8	32	Black
LE-1025P10V04	10	8	32	Blue
LE-1025P12V01	12	10	35	Black

100 Metre Coils

1012	OD mm	ID mm	Bend Radius mm	Colour
LE-1100P06V01	6	4	20	Black
LE-1100P08V01	8	6	25	Black
LE-1100P08V04	8	6	25	Blue

Anti-static Tubing

- Anti-static polyurethane tubing has a low surface resistance (103 ohms) and is designed to prevent accumulation of electrostatic charges.



100 Metre Coils

1012	OD mm	ID mm	Bend Radius mm
LE-1100U03A01	3	1.5	8
LE-1100U06A01	6	4	15
LE-1100U08A01	8	5.5	25
LE-1100U10A01	10	7	35

Stripping Tool

- For use on anti-spark tube.



1012
LE-60007100

Translucent Silicone Tubing

Translucent silicone tube is non-toxic and biologically inert. It is FDA, BGA, WRC and NWC approved for drug and medical use, and meets European Pharmacopoeia class VI. Outstanding temperature resistance from -60°C to +200°C, it can withstand repeated autoclaving. Excellent chemical resistance (contact technical department for advice).

Not suitable for high pressure applications.

Working Temperature:
-60°C to +200°C



10 Metre Coils

5012	OD mm	ID mm	Wall Thickness mm
TST-04/020	2	4	1
TST-06/040	4	6	1
TST-08/050	5	8	1.5
TST-10/080	8	10	1
TST-12/080	8	12	2

FEP Tubing



10 Metre Coils

5012	OD mm
4500400100	6
4500600100	8

Tech Sheet 20216

PFA Tubing



10 Metre Coils

5012	OD mm	OD
4601000100	12	-
4600952159	-	1/2"

Tech Sheet 60553

PTFE Tubing (Polytetrafluoroethylene)

The unique properties of PTFE are excellent. Enjoying a non-stick/low friction release property and a very wide temperature range, it is virtually inert to all known chemicals and solvents. It exhibits extremely good electrical insulation properties and good weatherability. All these characteristics combined make PTFE the ideal material for innumerable applications.

Please note: no recommended burst pressures/working pressures due to hose being unreinforced.



10 Metre Coils

5012	ID mm	OD mm	Wall Thickness mm
TPTFE-04/025-10M	2.5	4	0.75
TPTFE-06/040-10M	4	6	1
TPTFE-08/060-10M	6	8	1
TPTFE-10/080-10M	8	10	1
TPTFE-12/010-10M	10	12	1

Tech Sheet 1379

30 Metre Coils

5012	ID mm	OD mm	Wall Thickness mm
TPTFE-04/025-30M	2.5	4	0.75
TPTFE-06/040-30M	4	6	1
TPTFE-08/060-30M	6	8	1
TPTFE-10/080-30M	8	10	1
TPTFE-12/010-30M	10	12	1

Tech Sheet 1379

LDP Low Density Polyethylene Tube



30 Metre Coils

5040	ID mm	OD mm	Max Pressure PSI	Max Pressure Bar
LDP04/025	4	2.5	200	13.5
LDP05/030	5	3	200	13.5
LDP06/040	6	4	185	12.5
LDP08/060	8	6	165	11
LDP10/080	10	8	150	10
LDP12/100	12	10	90	6

Customers who bought from this page also purchased...



Pneumatic Quick Release Series 21 Worldwide Profile Thermoplastic Couplings



...see pages 347-349

Air Brake Tubing DIN 74324

° Working Temperature:
-20°C to +70°C



- Manufactured from heat and light stabilised polyamide. This tube has excellent low density, low water absorption, physical properties and dimensions relatively constant even during humidity changes.
- Other colours available on request, minimum order of 20 x 30 metre coils.

30 Metre Coils

5040	OD mm	ID mm	Colour	Max Pressure Bar
AB4230	4	2	Black	45
AB6430	6	4	Black	27
AB10730	10	7	Black	19
AB12930	12	9	Black	19
AB161230	16	12	Black	19
AB181430	18	14	Black	17

SIRIT
AIR BRAKE FITTINGS



For Air Brake Fittings
see pages 887-889

Nylon 12 Air Brake Coils, DIN 73378, SAE J 844 Type B

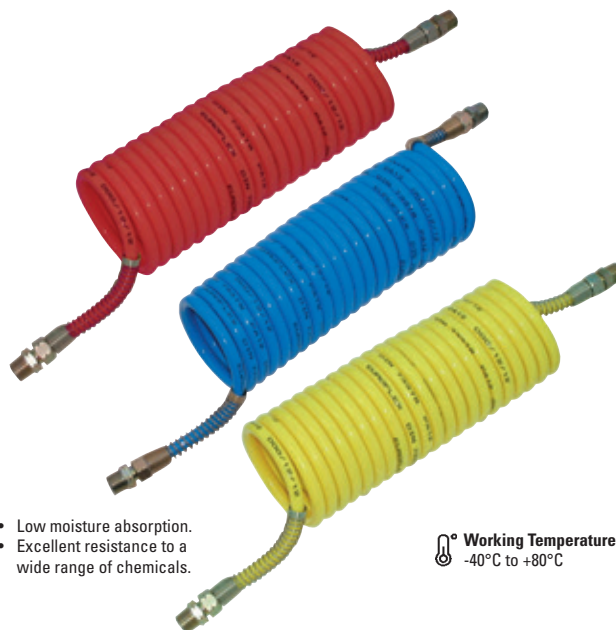

- Low moisture absorption.
- Excellent resistance to a wide range of chemicals.

° Working Temperature:
-40°C to +80°C

Red, Emergency Line, 1/2" BSPT

0306	ID mm	OD mm	Working Length Metres	Rotation
AB129035R	12	9	3.5	16
AB129050R	12	9	5	22

Tech Sheet 20391

Blue, Auxiliary Line, 1/2" BSPT

0306	ID mm	OD mm	Working Length Metres	Rotation
AB129035B	12	9	3.5	16
AB129050B	12	9	5	22

Tech Sheet 20391

Yellow, Service Line, 1/2" BSPT

0306	ID mm	OD mm	Working Length Metres	Rotation
AB129035Y	12	9	3.5	16
AB129050Y	12	9	5	22

Tech Sheet 20391

TUBING

For the full range and more information, please contact one of our sales team.

POLYURETHANE TUBING

FESTO

Features

- Extremely flexible polyurethane tubing
- High resistance to stress cracks
- Suitable for use with energy chains
- Food safe - FDA Compliant
- Plastic tubing PUN-H-F
- Polyurethane
- High resistance to microbes and hydrolysis
- Clean room-compatible combination with fitting NPKA
- Operating medium: compressed air, vacuum and water

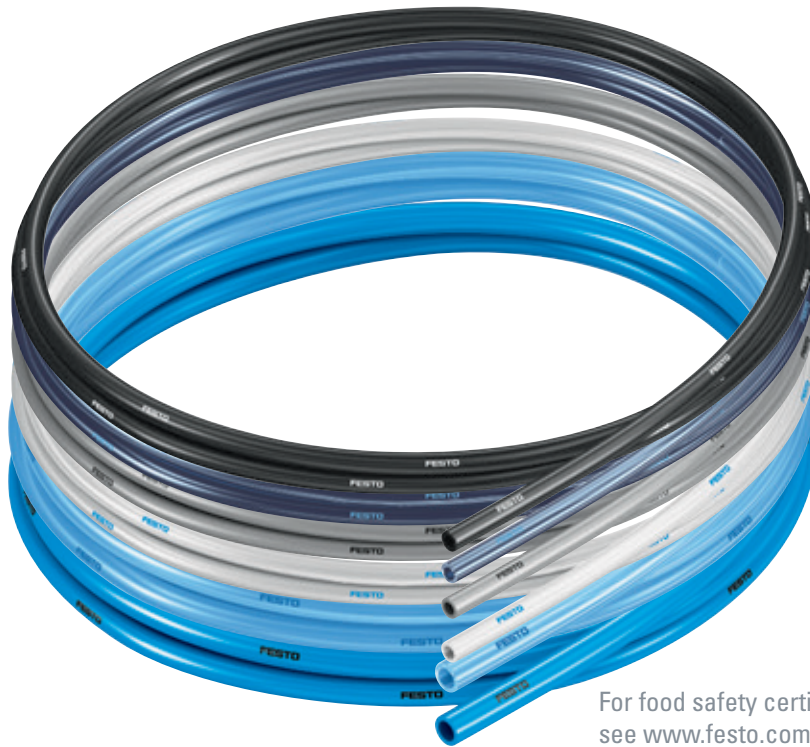

For food safety certificates, see www.festo.com/certificates/PUN_H_F

Product Description

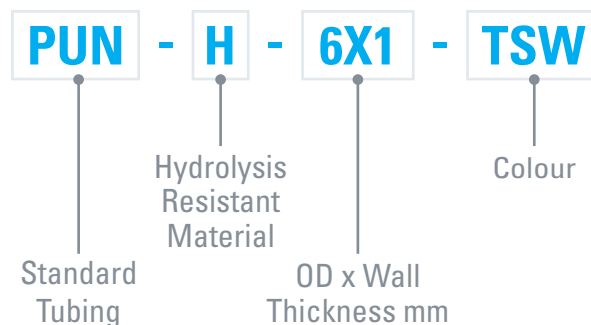

POLYURETHANE TUBING

Hydrolysis-resistant

- Extremely flexible polyurethane tubing
- Suitable for use with energy chains
- Operating media: compressed air, vacuum and water

Working Temperature:
-35°C to +60°C

Maximum Working Pressure: 10 bar

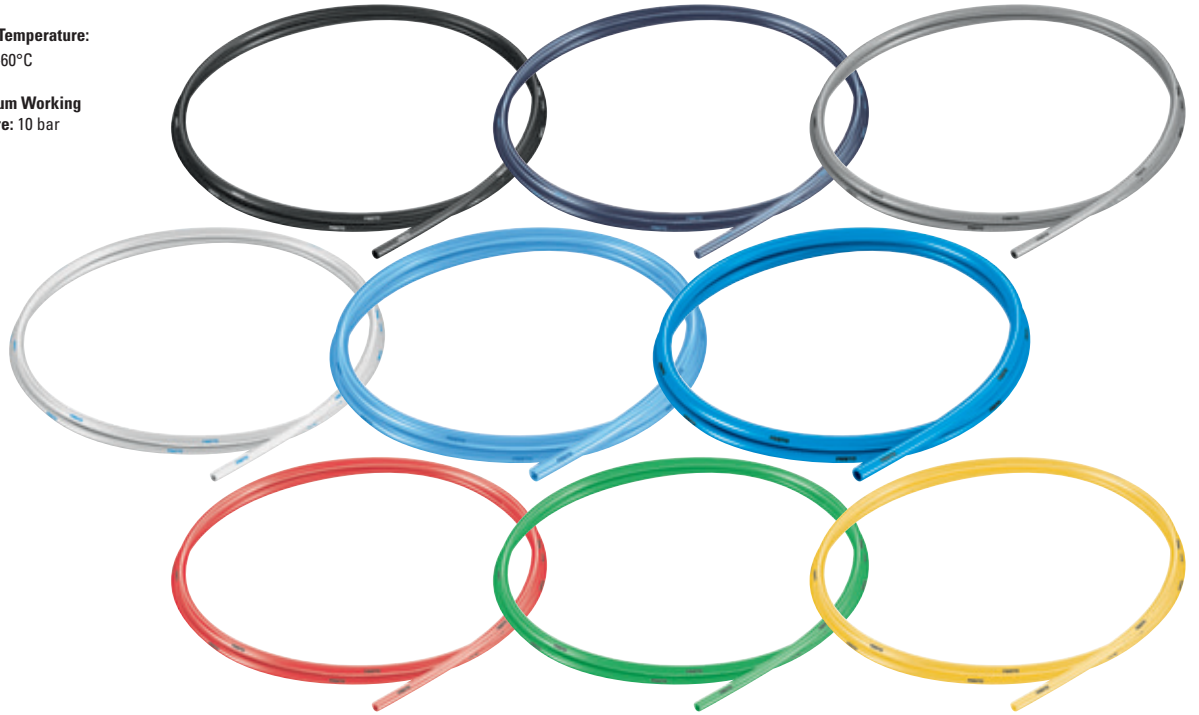

50 Metres

0011	OD mm	ID mm	Colour	Manufacturer's Code
197390	4	2.6	Black	PUN-H-4X0,75-SW
8048673	4	2.6	Translucent Black	PUN-H-4X0,75-TSW
8048675	4	2.6	Translucent Red	PUN-H-4X0,75-TRT
197383	4	2.6	Blue	PUN-H-4X0,75-BL
197376	4	2.6	Natural	PUN-H-4X0,75-NT
558278	4	2.6	Silver	PUN-H-4X0,75-SI
8048677	4	2.6	Translucent Green	PUN-H-4X0,75-TGN
8048679	4	2.6	Translucent Yellow	PUN-H-4X0,75-TGE
8048671	4	2.6	Translucent Blue	PUN-H-4X0,75-TBL
8048683	6	4	Translucent Black	PUN-H-6X1-TSW
197384	6	4	Blue	PUN-H-6X1-BL
8048681	6	4	Translucent Blue	PUN-H-6X1-TBL
197377	6	4	Natural	PUN-H-6X1-NT
558279	6	4	Silver	PUN-H-6X1-SI
197391	6	4	Black	PUN-H-6X1-SW
8048685	6	4	Translucent Red	PUN-H-6X1-TRT
8048687	6	4	Translucent Green	PUN-H-6X1-TGN

0011	OD mm	ID mm	Colour	Manufacturer's Code
8048689	6	4	Translucent Yellow	PUN-H-6X1-TGE
8048693	8	5.7	Translucent Black	PUN-H-8X1,25-TSW
8048691	8	5.7	Translucent Blue	PUN-H-8X1,25-TBL
8048695	8	5.7	Translucent Red	PUN-H-8X1,25-TRT
8048697	8	5.7	Translucent Green	PUN-H-8X1,25-TGN
8048699	8	5.7	Translucent Yellow	PUN-H-8X1,25-TGE
8048705	10	7	Translucent Red	PUN-H-10X1,5-TRT
8048707	10	7	Translucent Green	PUN-H-10X1,5-TGN
8048709	10	7	Translucent Yellow	PUN-H-10X1,5-TGE
8048703	10	7	Translucent Black	PUN-H-10X1,5-TSW
8048701	10	7	Translucent Blue	PUN-H-10X1,5-TBL
8048715	12	8	Translucent Red	PUN-H-12X2-TRT
8048717	12	8	Translucent Green	PUN-H-12X2-TGN
8048719	12	8	Translucent Yellow	PUN-H-12X2-TGE
8048713	12	8	Translucent Black	PUN-H-12X2-TSW
8048711	12	8	Translucent Blue	PUN-H-12X2-TBL

Tech Sheet 70006



REACH ✓

RoHS

Nylon Tubing & Tube Cutters



Metric Flexible Nylon Tubing, Type NT (to BS5409)

Working Temperature
-10°C to +80°C

Tube is not suitable for use with water or in high humidity environments.

- U.V. stable.
- Silicone free.
- Abrasion resistant.
- Manufactured from quality grade nylon granules.

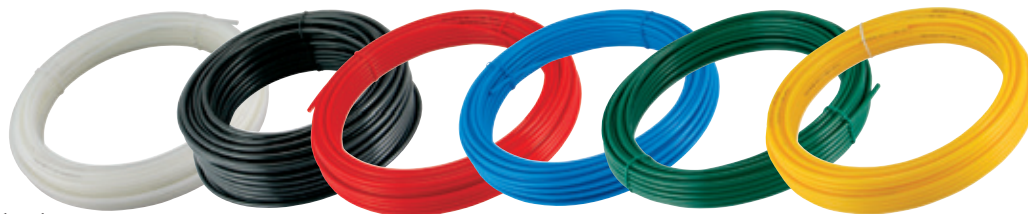

Other colours and lengths available on request

The properties of this tube make it ideal for use in pneumatic control systems. (Ideally suited for use with push-in fittings).

30 Metre Coils

5010	OD mm	ID mm	Colour	Max Pressure PSI	Max Pressure Bar
NTM04/030	4	3	□	300	21
NTM04/025	4	2.5	□	400	28
NTM04/025N	4	2.5	■	400	28
NTM04/025B	4	2.5	■	400	28
NTM04/025G	4	2.5	■	400	28
NTM04/025R	4	2.5	■	400	28
NTM04/025Y	4	2.5	■	400	28
NTM05/030	5	3	□	400	28
NTM05/030N	5	3	■	400	28
NTM05/030B	5	3	■	400	28
NTM05/030G	5	3	■	400	28
NTM05/030R	5	3	■	400	28
NTM05/030Y	5	3	■	400	28
NTM06/040	6	4	□	350	24
NTM06/040N	6	4	■	350	24
NTM06/040B	6	4	■	350	24
NTM06/040G	6	4	■	350	24
NTM06/040R	6	4	■	350	24
NTM06/040Y	6	4	■	350	24
NTM08/060	8	6	□	350	24
NTM08/060N	8	6	■	350	24
NTM08/060B	8	6	■	350	24
NTM08/060G	8	6	■	350	24
NTM08/060R	8	6	■	350	24
NTM08/060Y	8	6	■	350	24
NTM08/055	8	5.5	□	350	24

30 Metre Coils

5010	OD mm	ID mm	Colour	Max Pressure PSI	Max Pressure Bar
NTM08/055N	8	5.5	■	350	24
NTM10/070	10	7	□	300	21
NTM10/070N	10	7	■	300	21
NTM10/070B	10	7	■	300	21
NTM10/070G	10	7	■	300	21
NTM10/070R	10	7	■	300	21
NTM10/070Y	10	7	■	300	21
NTM10/080	10	8	□	220	15
NTM10/080N	10	8	■	220	15
NTM10/080B	10	8	■	220	15
NTM10/080G	10	8	■	220	15
NTM10/080R	10	8	■	220	15
NTM10/080Y	10	8	■	220	15
NTM12/090	12	9	□	250	17
NTM12/090N	12	9	■	250	17
NTM12/090B	12	9	■	250	17
NTM12/090G	12	9	■	250	17
NTM12/090R	12	9	■	250	17
NTM12/090Y	12	9	■	250	17
NTM12/100	12	10	□	200	14
NTM12/100N	12	10	■	200	14
NTM12/100R	12	10	■	200	14
NTM14/110	14	11	□	250	17
NTM14/110N	14	11	■	250	17
NTM15/120	15	12	□	200	14
NTM16/130	16	13	□	200	14
NTM18/140	18	14	□	200	14
NTM22/170	22	17	□	180	17

Tech Sheet 3136

100 Metre Coils

5010	OD mm	ID mm	Colour	PSI	Max Pressure Bar
NTM06/040-100	6	4	□	350	24
NTM06/040N-100	6	4	■	350	24
NTM06/040B-100	6	4	■	350	24
NTM06/040G-100	6	4	■	350	24
NTM06/040R-100	6	4	■	350	24
NTM06/040Y-100	6	4	■	350	24
NTM08/060-100	8	6	□	350	24
NTM08/060N-100	8	6	■	350	24
NTM08/060B-100	8	6	■	350	24
NTM10/080-100	10	8	□	220	15
NTM10/080N-100	10	8	■	220	15
NTM10/080B-100	10	8	■	220	15

Tech Sheet 3136

Nylon & Polyurethane Tube Cutter

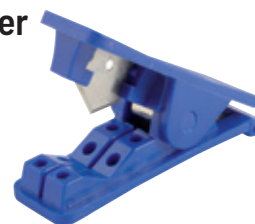

3mm-16mm

5010	Colour
KTC-1	■

Tech Sheet 3136



For Push-in Fittings see pages 767-791



Imperial Flexible Nylon Tubing, (to BS5409)



Working Temperature
-10°C to +80°C

Tube is not suitable for use with water or in high humidity environments.

Specifications



Standard Coil Length:
30 Metres

(other colours and lengths available on request).

Manufactured from top quality crystal clear “virgin” nylon compound. This hose is ideal for factory airlines, fluid systems and many industrial applications.

The hose is resistant to a wide range of chemicals (please consult our Business Development Team for further details).



U.V. stable.



Silicone free.



Abrasion resistant.

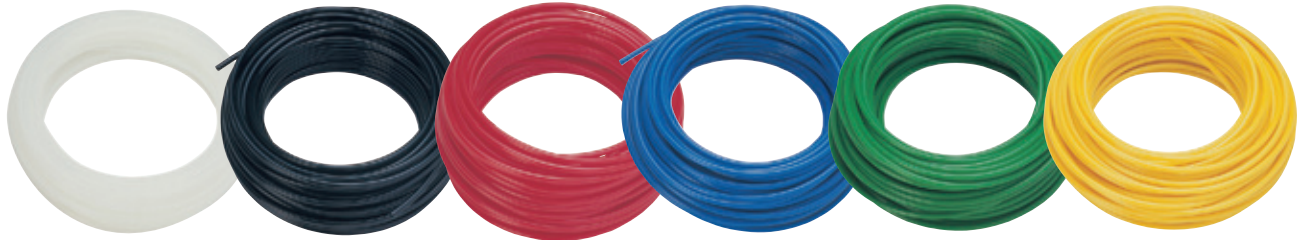

30 Metre Coils

5010	OD	ID	Colour	Max Pressure PSI	Max Pressure Bar
NTI118/075	1/8"	0.075	□	300	21
NTI532/096	5/32"	0.096	□	250	17
NTI316/117	3/16"	0.117	□	300	21
NTI316/117N	3/16"	0.117	■	300	21
NTI14/170	1/4"	0.17	□	300	21
NTI14/170B	1/4"	0.17	■	300	21
NTI14/170G	1/4"	0.17	■	300	21
NTI14/170R	1/4"	0.17	■	300	21
NTI14/170Y	1/4"	0.17	■	300	21
NTI14/170N	1/4"	0.17	■	300	21
NTI516/212	5/16"	0.212	□	250	17
NTI516/212B	5/16"	0.212	■	250	17
NTI516/212R	5/16"	0.212	■	250	17
NTI516/212N	5/16"	0.212	■	250	17
NTI38/250	3/8"	0.25	□	250	17

5010	OD	ID	Colour	Max Pressure PSI	Max Pressure Bar
NTI38/250B	3/8"	0.25	■	250	17
NTI38/250G	3/8"	0.25	■	250	17
NTI38/250R	3/8"	0.25	■	250	17
NTI38/250Y	3/8"	0.25	■	250	17
NTI38/250N	3/8"	0.25	■	250	17
NTI12/375	1/2"	0.375	□	250	17
NTI12/375B	1/2"	0.375	■	250	17
NTI12/375G	1/2"	0.375	■	250	17
NTI12/375R	1/2"	0.375	■	250	17
NTI12/375Y	1/2"	0.375	■	250	17
NTI12/375N	1/2"	0.375	■	250	17
NTI34/594	3/4"	0.594	□	200	14
NTI58/500	5/8"	0.5	□	200	14
NTI1/813	1"	0.813	□	180	12

Tech Sheet 20895



REACH ✓

RoHS

Nylon Tubing FT PRO®

Metric Flexible Nylon Tubing, (to BS5409, DIN 73378 & ISO 7628)



Working Temperature
-40°C to +80°C

Manufactured from extremely high grade nylon granules, this hose gives almost total resistance to abrasion and many more chemicals including dilute acid and alkaline.

The properties of this tube make it ideal for use in pneumatic

control systems, fuel lines, lubrication and also within the food, beverage and brewing industry (ideally suited for use with push-in fittings).

Working pressure will differ at higher temperatures.

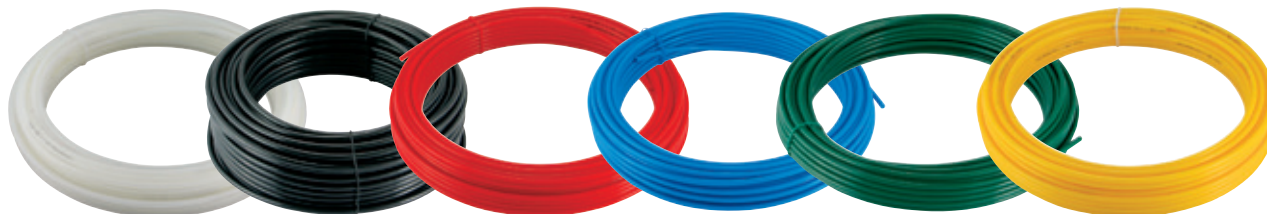

30 Metre Coils

0306	OD mm	ID mm	Colour	Max Pressure PSI	Max Pressure Bar
BNTM03/015	3	1.5	□	200	13
BNTM04/2	4	2	□	350	24
BNTM04/025	4	2.5	□	400	27
BNTM04/025N	4	2.5	■	400	27
BNTM04/025B	4	2.5	■	400	27
BNTM04/025G	4	2.5	■	400	27
BNTM04/025R	4	2.5	■	400	27
BNTM05/030	5	3	□	400	27
BNTM05/030N	5	3	■	400	27
BNTM05/030B	5	3	■	400	27
BNTM06/030	6	3	□	350	24
BNTM06/040	6	4	□	350	24
BNTM06/040N	6	4	■	350	24
BNTM06/040B	6	4	■	350	24
BNTM06/040G	6	4	■	350	24
BNTM06/040R	6	4	■	350	24
BNTM06/040Y	6	4	■	350	24
BNTM08/060	8	6	□	350	24
BNTM08/060N	8	6	■	350	24
BNTM08/060B	8	6	■	350	24
BNTM08/060G	8	6	■	350	24
BNTM08/060R	8	6	■	350	24
BNTM08/060Y	8	6	■	350	24
BNTM10/070	10	7	□	300	20
BNTM10/070N	10	7	■	300	20
BNTM10/070B	10	7	■	300	20
BNTM10/070R	10	7	■	300	20
BNTM10/080	10	8	□	220	15
BNTM10/080N	10	8	■	220	15
BNTM10/080B	10	8	■	220	15
BNTM10/080R	10	8	■	220	15
BNTM12/090	12	9	□	250	17
BNTM12/090N	12	9	■	250	17
BNTM12/090B	12	9	■	250	17
BNTM12/090R	12	9	■	250	17
BNTM12/100	12	10	□	200	13
BNTM12/100N	12	10	■	200	13
BNTM14/110	14	11	□	250	17
BNTM14/110N	14	11	■	250	17

Tech Sheet 1386

100 Metre Coils

0306	OD mm	ID mm	Colour	Max Pressure PSI	Max Pressure Bar
BNTM04/025-100	4	2.5	□	400	27
BNTM05/030-100	5	3	□	400	27
BNTM06/040-100	6	4	□	350	24
BNTM06/040N-100	6	4	■	350	24
BNTM06/040B-100	6	4	■	350	24
BNTM06/040G-100	6	4	■	350	24
BNTM06/040R-100	6	4	■	350	24
BNTM06/040Y-100	6	4	■	350	24
BNTM08/060-100	8	6	□	350	24
BNTM08/060N-100	8	6	■	350	24
BNTM08/060B-100	8	6	■	350	24
BNTM08/060G-100	8	6	■	350	24
BNTM08/060R-100	8	6	■	350	24
BNTM08/060Y-100	8	6	■	350	24
BNTM10/080-100	10	8	□	220	15
BNTM10/080N-100	10	8	■	220	15
BNTM10/080B-100	10	8	■	220	15
BNTM10/080R-100	10	8	■	220	15

Tech Sheet 1386

- ✓ High resistance to moisture absorption.
- ✓ Suitable for use in air brake systems.
- ✓ Suitable for fuel and lubrication systems. 4 to 1 safety factor.
- ✓ Very stable in moisture type atmospheres.

Nylon 12 Coil Hose with Tails



Working Temperature
-40°C to +80°C

Applications:

- Fuel lines.
- Oil lines.
- Petrol tank breather lines.
- Pneumatic lines.
- Bleed lines.
- Brake controls.



Low moisture absorption.



Excellent resistance to a wide range of chemicals.



Safety factor of 3 to 1.

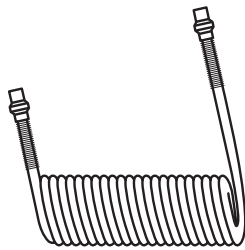

BSPT

0306	ID mm	OD mm	Working Length Metres	Thread	Colour
N12C60402.5MB	4	6	2.5	1/4"	Blue
N12C60405MB	4	6	5	1/4"	Blue
N12C604010MB	4	6	10	1/4"	Blue
N12C604015MB	4	6	15	1/4"	Blue
N12C60402.5MR	4	6	2.5	1/4"	Red
N12C60405MR	4	6	5	1/4"	Red
N12C604010MR	4	6	10	1/4"	Red
N12C604015MR	4	6	15	1/4"	Red
N12C80602.5MB	6	8	2.5	1/4"	Blue
N12C80605MB	6	8	5	1/4"	Blue
N12C806010MB	6	8	10	1/4"	Blue
N12C806015MB	6	8	15	1/4"	Blue
N12C80602.5MR	6	8	2.5	1/4"	Red
N12C80605MR	6	8	5	1/4"	Red
N12C806010MR	6	8	10	1/4"	Red
N12C806015MR	6	8	15	1/4"	Red
N12C100802.5MB	8	10	2.5	1/4"	Blue
N12C100805MB	8	10	5	1/4"	Blue
N12C1008010MB	8	10	10	1/4"	Blue
N12C1008015MB	8	10	15	1/4"	Blue

0306	ID mm	OD mm	Working Length Metres	Thread	Colour
N12C100802.5MR	8	10	2.5	1/4"	Red
N12C100805MR	8	10	5	1/4"	Red
N12C1008010MR	8	10	10	1/4"	Red
N12C1008015MR	8	10	15	1/4"	Red
N12C120902.5MB	9	12	2.5	3/8"	Blue
N12C120905MB	9	12	5	3/8"	Blue
N12C1209010MB	9	12	10	3/8"	Blue
N12C1209015MB	9	12	15	3/8"	Blue
N12C120902.5MR	9	12	2.5	3/8"	Red
N12C120905MR	9	12	5	3/8"	Red
N12C1209010MR	9	12	10	3/8"	Red
N12C1209015MR	9	12	15	3/8"	Red
N12C120902.5MB12	9	12	2.5	1/2"	Blue
N12C120905MB12	9	12	5	1/2"	Blue
N12C1209010MB12	9	12	10	1/2"	Blue
N12C1209015MB12	9	12	15	1/2"	Blue
N12C120902.5MR12	9	12	2.5	1/2"	Red
N12C120905MR12	9	12	5	1/2"	Red
N12C1209010MR12	9	12	10	1/2"	Red
N12C1209015MR12	9	12	15	1/2"	Red

Tech Sheet 3138



REACH ✓

RoHS

Nylon Tubing **FT PRO**

Food Grade Semi-rigid Nylon Tubing



Working Temperature
-40°C to +110°C continuous
(+140°C intermittent)



30 Metre Coils, Imperial

5015	ID	OD	Max Pressure PSI	Max Pressure Bar
SRN18	0.075"	1/8"	967	67
SRN316	0.117"	3/16"	868	60
SRN14	0.170"	1/4"	683	47
SRN516	0.212"	5/16"	684	47
SRN38	0.250"	3/8"	725	50
SRN12	0.375"	1/2"	483	33
SRN58	0.500"	5/8"	363	25

Tech Sheet 67981

30 Metre Coils, Metric

5015	ID mm	OD mm	Max Pressure PSI	Max Pressure Bar
SRN4	2.5	4	870	60
SRN5	3	5	967	67
SRN6	4	6	725	50
SRN8	6	8	483	34
SRN10	8	10	363	25
SRN1012	10	12	290	20
SRN15	12	15	363	25

Tech Sheet 67981

NYLON TUBING



Semi-rigid Nylon Multitube Close Tolerance

Legris semi-rigid nylon multitube is suited to pneumatic circuits submitted to external aggression.

Its PVC sheath is resistant to abrasion, fire, caustic fluids, oils, alcohol etc.

The special design sheath and spiral assembly ensure a small bend radius for compact and flexible cabling.

For fast identification of circuits, tubes are numbered from 1 to 12 and 6 colours are available.

Note: Also available in 25 metre and 50 metre coils.

10 Metre Coils

1012	Tube Quantity	ID mm	OD mm
LE-1010P04 00M04	4	2.7	4
LE-1010P04 00M07	7	2.7	4
LE-1010P06 00M04	4	4	6
LE-1010P06 00M07	7	4	6
LE-1010P08 00M02	2	6	8

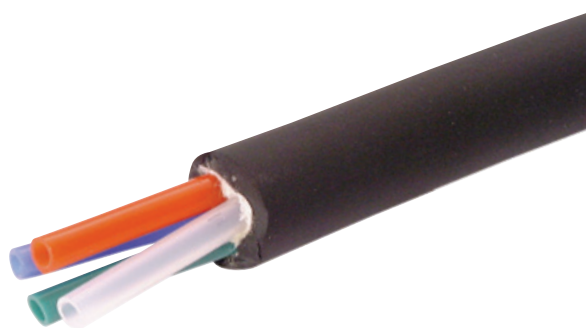

LLDPE & SYNIFLEX TUBE

Tubing LLDPE



Maximum Working Temperature:
180°F / 80°C (temperature and pressure variations apply*)

Strong but flexible, LLDPE tubing is suitable for use with super Speedfit push in fittings and virtually all standard tubing connectors.

The John Guest PE range of plastic tubing is produced in linear low density polyethylene for cold and intermittent hot water applications.

NOTE:

LLDPE IS NOT RECOMMENDED FOR HIGH PRESSURE COMPRESSED AIR SYSTEMS 10 bar+, MINERAL OILS, GASES AND FUELS.

- Other colours available white, green, yellow, orange and violet.
Minimum order 500m. POA.

100 Metre Coils

1400	OD mm	ID mm	Colour
PE-04025-0100M-N	4	2.5	Natural
PE-04025-0100M-B	4	2.5	Blue
PE-04025-0100M-E	4	2.5	Black
PE-0604-0100M-N	6	4	Natural
PE-0604-0100M-B	6	4	Blue
PE-0604-0100M-R	6	4	Red
PE-0604-0100M-E	6	4	Black
PE-0806-100M-N	8	6	Natural
PE-0806-100M-B	8	6	Blue
PE-0806-100M-E	8	6	Black
PE-1007-100M-N	10	7	Natural
PE-1007-100M-B	10	7	Blue
PE-1007-100M-R	10	7	Red
PE-1007-100M-E	10	7	Black
PE-1209-100M-B	12	9	Blue
PE-1209-100M-R	12	9	Red
PE-1209-100M-E	12	9	Black

Tech Sheet 2057

Tubing

Synflex
by Danfoss



Application: Synflex 1300 is a unique composite-wall tubing designed for pneumatic instrument control systems. Its fully bonded polyethylene/aluminium construction combines the advantages of both metal and plastic tubing.

Chemical Resistance: The outer, high density polyethylene layer is impervious to most chemical-containing atmospheres and enables Synflex 1300 to out perform practically all types of unprotected metal tubing.

Metric, 25 Metre Coils

5074	OD mm
MAL6-25	6
MAL8-25	8
MAL10-25	10
MAL12-25	12

Tech Sheet 593

Imperial, 25 Metre Coils

5074	OD
MAL1/4-25-IMP	1/4"

Tech Sheet 593

Imperial, 75 Metre Coils

5074	OD
MAL1/4-75-IMP	1/4"
MAL3/8-75-IMP	3/8"
MAL1/2-75-IMP	1/2"

Tech Sheet 593

Customers who bought from this page also purchased...



**Pneumatic Quick Release
Series 25 Couplings see pages 359-361**

